



Operation Manual

PRODUCT NAME

Fieldbus system
SI unit (CANopen compatible)

MODEL / Series/ Product Number

EX250-SCA1B

SMC Corporation

Table of Contents

Safety Instructions	3
Model Indication and How to Order	9
Summary of Product parts	9
Mounting and Installation	10
Installation	10
Wiring	11
Setting	16
Setting of baud rate (Communication speed)	18
Overview object dictionary for communication object area	19
Overview object dictionary for manufacturer specific area	27
Overview object dictionary for device profile specific area	28
Error control services	33
Emergency object	34
Service data object (SDO)	35
Abort SDO transfer	36
Process data object (PDO)	37
Pre-defined connection set	38
Layer setting services (LSS)	39
Specification	47
Specifications	47
Dimensions	48



Safety Instructions

These safety instructions are intended to prevent hazardous situations and/or equipment damage. These instructions indicate the level of potential hazard with the labels of "Caution", "Warning" or "Danger".

They are all important notes for safety and must be followed in addition to International Standards (ISO/IEC)*1), and other safety regulations.

*1) ISO 4414: Pneumatic fluid power -- General rules relating to systems.

ISO 4413: Hydraulic fluid power -- General rules relating to systems.

IEC 60204-1: Safety of machinery -- Electrical equipment of machines. (Part 1: General requirements)

ISO 10218: Manipulating industrial robots -Safety.

etc.



Caution

Caution indicates a hazard with a low level of risk which, if not avoided, could result in minor or moderate injury.



Warning

Warning indicates a hazard with a medium level of risk which, if not avoided, could result in death or serious injury.



Danger

Danger indicates a hazard with a high level of risk which, if not avoided, will result in death or serious injury.

Warning

1. The compatibility of the product is the responsibility of the person who designs the equipment or decides its specifications.

Since the product specified here is used under various operating conditions, its compatibility with specific equipment must be decided by the person who designs the equipment or decides its specifications based on necessary analysis and test results.

The expected performance and safety assurance of the equipment will be the responsibility of the person who has determined its compatibility with the product.

This person should also continuously review all specifications of the product referring to its latest catalog information, with a view to giving due consideration to any possibility of equipment failure when configuring the equipment.

2. Only personnel with appropriate training should operate machinery and equipment.

The product specified here may become unsafe if handled incorrectly.

The assembly, operation and maintenance of machines or equipment including our products must be performed by an operator who is appropriately trained and experienced.

3. Do not service or attempt to remove product and machinery/equipment until safety is confirmed.

1. The inspection and maintenance of machinery/equipment should only be performed after measures to prevent falling or runaway of the driven objects have been confirmed.

2. When the product is to be removed, confirm that the safety measures as mentioned above are implemented and the power from any appropriate source is cut, and read and understand the specific product precautions of all relevant products carefully.

3. Before machinery/equipment is restarted, take measures to prevent unexpected operation and malfunction.

4. Contact SMC beforehand and take special consideration of safety measures if the product is to be used in any of the following conditions.

1. Conditions and environments outside of the given specifications, or use outdoors or in a place exposed to direct sunlight.

2. Installation on equipment in conjunction with atomic energy, railways, air navigation, space, shipping, vehicles, military, medical treatment, combustion and recreation, or equipment in contact with food and beverages, emergency stop circuits, clutch and brake circuits in press applications, safety equipment or other applications unsuitable for the standard specifications described in the product catalog.

3. An application which could have negative effects on people, property, or animals requiring special safety analysis.

4. Use in an interlock circuit, which requires the provision of double interlock for possible failure by using a mechanical protective function, and periodical checks to confirm proper operation.



Safety Instructions

Caution

1. The product is provided for use in manufacturing industries.

The product herein described is basically provided for peaceful use in manufacturing industries. If considering using the product in other industries, consult SMC beforehand and exchange specifications or a contract if necessary.
If anything is unclear, contact your nearest sales branch.

Limited warranty and Disclaimer/Compliance Requirements

The product used is subject to the following "Limited warranty and Disclaimer" and "Compliance Requirements".

Read and accept them before using the product.

Limited warranty and Disclaimer

1. The warranty period of the product is 1 year in service or 1.5 years after the product is delivered, whichever is first.*2)

Also, the product may have specified durability, running distance or replacement parts. Please consult your nearest sales branch.

2. For any failure or damage reported within the warranty period which is clearly our responsibility, a replacement product or necessary parts will be provided.

This limited warranty applies only to our product independently, and not to any other damage incurred due to the failure of the product.

3. Prior to using SMC products, please read and understand the warranty terms and disclaimers noted in the specified catalog for the particular products.

*2) Vacuum pads are excluded from this 1 year warranty.

A vacuum pad is a consumable part, so it is warranted for a year after it is delivered.

Also, even within the warranty period, the wear of a product due to the use of the vacuum pad or failure due to the deterioration of rubber material are not covered by the limited warranty.

Compliance Requirements

1. The use of SMC products with production equipment for the manufacture of weapons of mass destruction (WMD) or any other weapon is strictly prohibited.

2. The exports of SMC products or technology from one country to another are governed by the relevant security laws and regulation of the countries involved in the transaction. Prior to the shipment of a SMC product to another country, assure that all local rules governing that export are known and followed.

Operator

- ◆ This operation manual is intended for those who have knowledge of machinery using pneumatic equipment, and have sufficient knowledge of assembly, operation and maintenance of such equipment. Only those persons are allowed to perform assembly, operation and maintenance.
- ◆ Read and understand this operation manual carefully before assembling, operating or providing maintenance to the product.

■ Precautions

Warning

- Do not disassemble, modify (including changing the printed circuit board) or repair.
An injury or failure can result.
- Do not operate the product outside of the specifications.
Do not use for flammable or harmful fluids.
Fire, malfunction, or damage to the product can result.
Verify the specifications before use.
- Do not operate in an atmosphere containing flammable or explosive gases.
Fire or an explosion can result.
This product is not designed to be explosion proof.
- If using the product in an interlocking circuit:
 - Provide a double interlocking system, for example a mechanical system.
 - Check the product regularly for proper operation.Otherwise malfunction can result, causing an accident.
- The following instructions must be followed during maintenance:
 - Turn off the power supply.
 - Stop the air supply, exhaust the residual pressure and verify that the air is released before performing maintenance.Otherwise an injury can result.

Caution

- After maintenance is complete, perform appropriate functional inspections.
Stop operation if the equipment does not function properly.
Safety cannot be assured in the case of unexpected malfunction.
- Provide grounding to assure the noise resistance of the Serial System.
Individual grounding should be provided close to the product with a short cable.

■ NOTE

- Follow the instructions given below when designing, selecting and handling the product.
- The instructions on design and selection (installation, wiring, environment, adjustment, operation, maintenance, etc.) described below must also be followed.
- * Product specifications
 - The direct current power supply to combine should be UL1310 Class 2 power supply when conformity to UL is necessary.
 - The SI unit is a UL approved product only if they have a  mark on the body.
 - Use the specified voltage.
Otherwise failure or malfunction can result.
 - Reserve a space for maintenance.
Allow sufficient space for maintenance when designing the system.
 - Do not remove any nameplates or labels.
This can lead to incorrect maintenance, or misreading of the operation manual, which could cause damage or malfunction to the product.
It may also result in non-conformity to safety standards.

•Product handling

*Installation

- Do not drop, hit or apply excessive shock to the fieldbus system.
Otherwise damage to the product can result, causing malfunction.
- Tighten to the specified tightening torque.
If the tightening torque is exceeded the mounting screws may be broken.
IP67 protection cannot be guaranteed if the screws are not tightened to the specified torque.
- Never mount a product in a location that will be used as a foothold.
The product may be damaged if excessive force is applied by stepping or climbing onto it.

*Wiring

- Avoid repeatedly bending or stretching the cables, or placing heavy load on them.
Repetitive bending stress or tensile stress can cause breakage of the cable.
- Wire correctly.
Incorrect wiring can break the product.
- Do not perform wiring while the power is on.
Otherwise damage to the fieldbus system and/or I/O device can result, causing malfunction.
- Do not route wires and cables together with power or high voltage cables.
Otherwise the fieldbus system and/or I/O device can malfunction due to interference of noise and surge voltage from power and high voltage cables to the signal line.
Route the wires (piping) of the fieldbus system and/or I/O device separately from power or high voltage cables.
- Confirm proper insulation of wiring.
Poor insulation (interference from another circuit, poor insulation between terminals, etc.) can lead to excess voltage or current being applied to the product, causing damage.
- Take appropriate measures against noise, such as using a noise filter, when the fieldbus system is incorporated into equipment.
Otherwise noise can cause malfunction.
- Separate the power line for output devices from the power line for control.
Otherwise noise or induced surge voltage can cause malfunction.

*Environment

- Select the proper type of protection according to the environment of operation.
IP65/67 protection is achieved when the following conditions are met.
(1) The units are connected properly with fieldbus cable with M12 connector and power cable with M12 (M8) connector.
(2) Suitable mounting of each unit and manifold valve.
If using in an environment that is exposed to water splashes, please take measures such as using a cover.
If the product is to be used in an environment containing oils or chemicals such as coolant or cleaning solvent, even for a short time, it may be adversely affected (damage, malfunction etc.).
- Do not use the product in an environment where corrosive gases or fluids could be splashed.
Otherwise damage to the product and malfunction can result.
- Do not use in an area where surges are generated.
If there is equipment which generates a large amount of surge (solenoid type lifter, high frequency induction furnace, motor, etc.) close to the fieldbus system, this may cause deterioration or breakage of the internal circuit of the fieldbus system. Avoid sources of surge generation and crossed lines.
- When a surge-generating load such as a relay or solenoid is driven directly, use an fieldbus system with a built-in surge absorbing element.
Direct drive of a load generating surge voltage can damage the fieldbus system.
- The product is CE/UKCA marked, but not immune to lightning strikes. Take measures against lightning strikes in the system.
- Prevent foreign matter such as remnant of wires from entering the fieldbus system to avoid failure and malfunction.

- Mount the product in a place that is not exposed to vibration or impact.
Otherwise failure or malfunction can result.
- Do not use the product in an environment that is exposed to temperature cycle.
Heat cycles other than ordinary changes in temperature can adversely affect the inside of the product.
- Do not expose the product to direct sunlight.
If using in a location directly exposed to sunlight, shade the product from the sunlight.
Otherwise failure or malfunction can result.
- Keep within the specified ambient temperature range.
Otherwise malfunction can result.
- Do not operate close to a heat source, or in a location exposed to radiant heat.
Otherwise malfunction can result.

*Adjustment and Operation

- Perform settings suitable for the operating conditions.
Incorrect setting can cause operation failure.
- Please refer to the PLC manufacturer's manual etc. for details of programming and addresses.
For the PLC protocol and programming refer to the relevant manufacturer's documentation.

*Maintenance

- Turn off the power supply, stop the supplied air, exhaust the residual pressure and verify the release of air before performing maintenance.
There is a risk of unexpected malfunction.
- Perform regular maintenance and inspections.
There is a risk of unexpected malfunction.
- After maintenance is complete, perform appropriate functional inspections.
Stop operation if the equipment does not function properly.
Otherwise safety is not assured due to an unexpected malfunction or incorrect operation.
- Do not use solvents such as benzene, thinner etc. to clean the each unit.
They could damage the surface of the body and erase the markings on the body.
Use a soft cloth to remove stains.
For heavy stains, use a cloth soaked with diluted neutral detergent and fully squeezed, then wipe up the stains again with a dry cloth.

Model Indication and How to Order

EX250-SCA1B

• Communication protocol

CA1	CANopen
-----	---------

Summary of Product parts

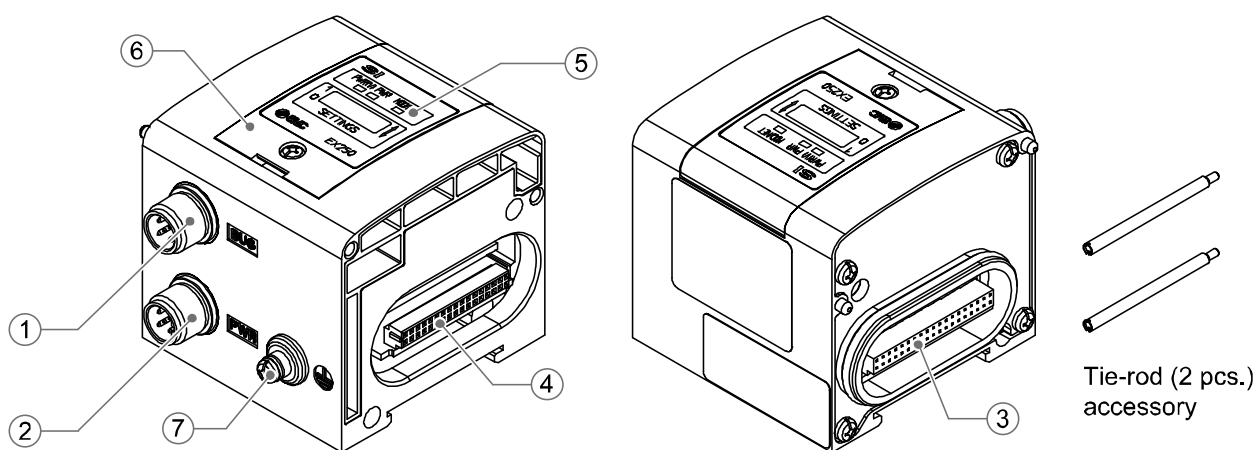

No.	Description	Application
1	Communication connector	Connect with CANopen communication line.
2	Power supply connector	To supply power to the solenoid valve, the Output block, SI unit and the Input block.
3	Input block connector	To connect the Input block.
4	Output block connector	To connect the solenoid valve, Output block and etc.
5	Display	LED display to indicate the SI unit status.
6	Switch protective cover	Set the node ID and Baud rate using the switches under the cover.
7	Ground terminal (FE)	To be connected to ground.

Mounting and Installation

■ Installation

Not having mounting hole, it can't be set to BUS independently. Be sure to connect manifold to SI unit for setting.

And if Input block is unnecessary, connect End plate directly to SI unit.

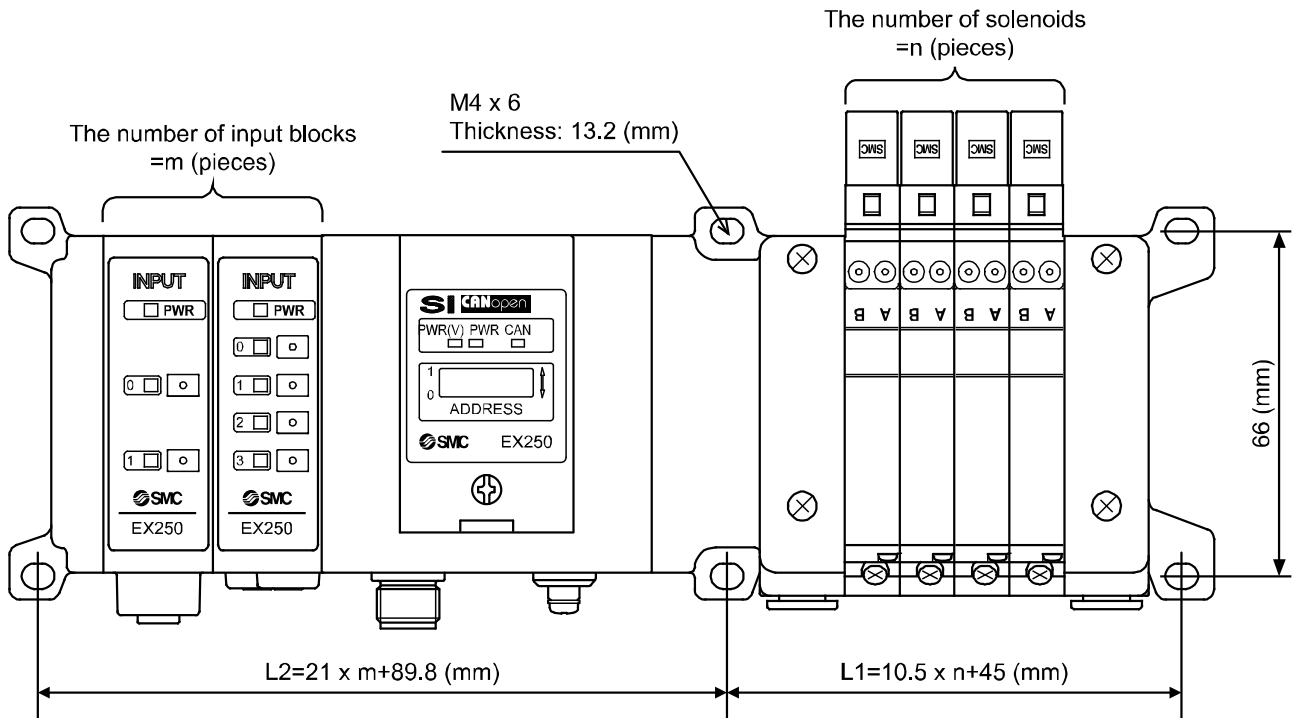

For example, the table below shows dimensions when used with the VQC1000 series valve manifold. Please refer to the individual catalog for dimensions when other manifolds are connected.

N*m L	0	1	2	3	4	5	6	7	8	9	10	11	12	13	14	15	16
L1	45	55.5	66	76.5	87	97.5	108	118.5	129	139.5	150	160.5	171	181.5	192	202.5	213
L2	89.8	110.8	131.8	152.8	173.8	194.8	215.8	236.8	257.8	278.8	299.8						

Wiring (for power supply, communication and input) and piping are installed on only one side of the product. On that side, allow sufficient space for wiring and piping.

Internal circuit

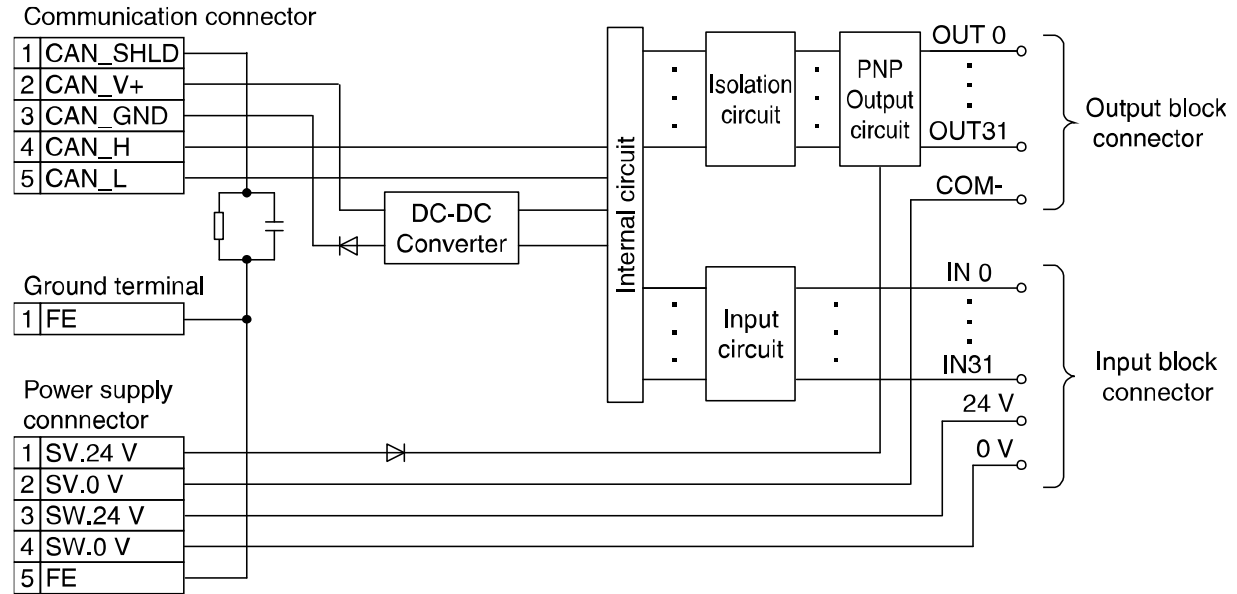

■Wiring

Communication connector M12 male 5-pin

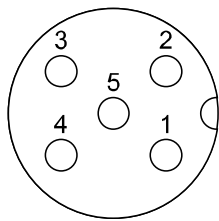

Pin No.	Description	Function
1	CAN_SHLD	Shield
2	CAN_V+	Power supply + for CANopen
3	CAN_GND	Power supply - for CANopen
4	CAN_H	CAN_H bus line (dominant high)
5	CAN_L	CAN_L bus line (dominant low)

(Example of connection cable: M12 female 5-pin cable with shield (according to ISO11898))

Baud rate and Bus cable length

The relationship between Baud rate and Bus cable length are as follows.

Baud rate	Max. bus cable length
1 Mbit/s	25 m
800 kbit/s	50 m
500 kbit/s	100 m
250 kbit/s	250 m
125 kbit/s	500 m
50 kbit/s	1000 m
20 kbit/s	2000 m

○Bus cable and termination resistors

The cables, connectors, and termination resistors used in CANopen networks shall meet the requirements defined in ISO 11898. In addition, the following are guidelines for selecting cables and connectors.

The table below shows some standard values for DC parameters for CANopen networks with less than 64 nodes.

Bus length [m]	Bus cable specification		Termination resistance [Ω]
	Length-related resistance [m Ω /m]	Cross-section [mm ²]	
0...40	<70	0.25...0.34	124
40...300	<60	0.34...0.6	150...300
300...600	<40	0.5...0.6	150...300
600...1000	<26	0.75...0.8	150...300

For drop cables, a wire cross-section of 0.25 to 0.34 mm² would be an appropriate choice in many cases. Besides the cable resistance, the real resistance of the connectors should also be considered, when calculating the voltage drop. The resistance of one connector should be in the range of 2.5 to 10 m Ω .

○Power supply connector M12 male 5-pin reverse key type

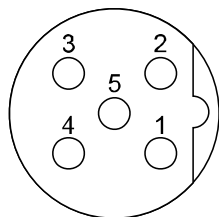

Pin No.	Description	Function
1	SV 24 V	+24 V for solenoid valve.
2	SV 0 V	0 V for solenoid valve
3	SW 24 V	+24 V for input block
4	SW 0 V	0 V for input block
5	FE	Functional earth

(Example of connection cable: EX9-AC050-1 etc.)

The Power supply connection inside the unit has individual power supplies for solenoid valve actuation (SV power supply) and for Input block (SW power supply). Supply 24 VDC for each of them. Either single or dual power supply can be used.

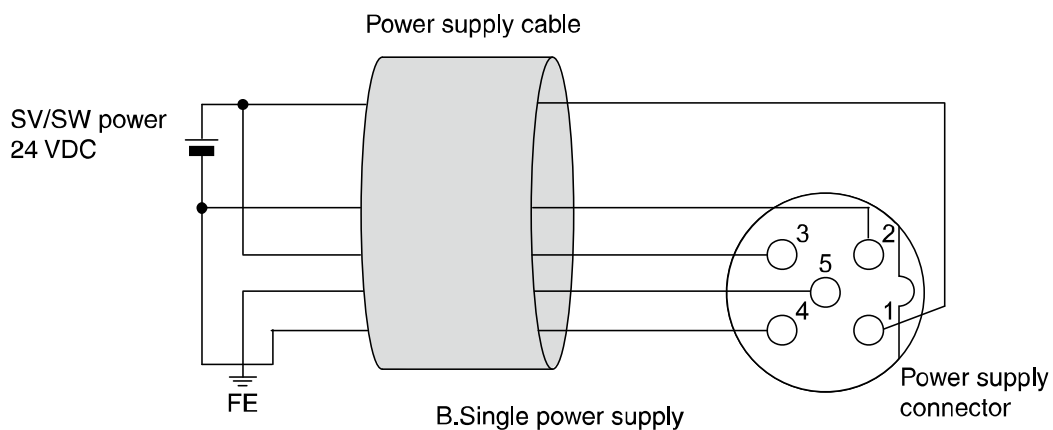
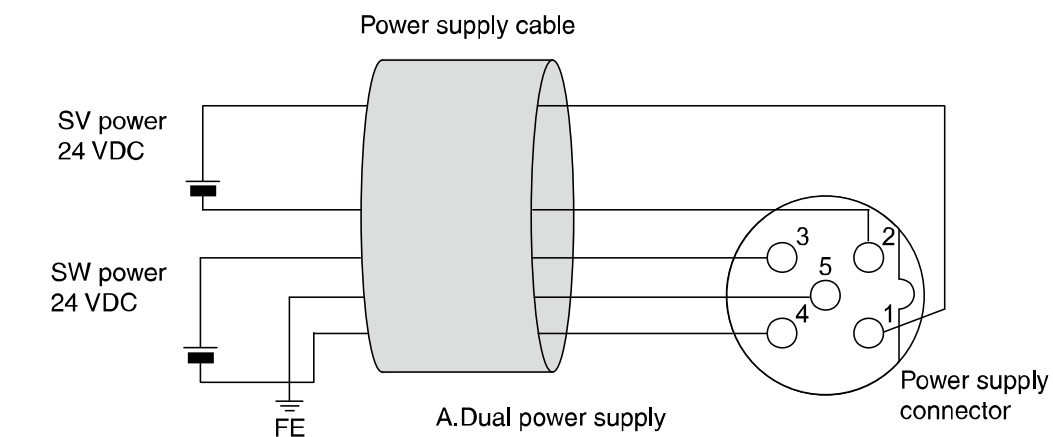

*: In case of single power supply, pay attention to the range of each supply voltage.

Power for a sensor is supplied to a sensor connected to the Input block. There will be a voltage drop of up to maximum 1 V inside the SI unit, therefore select a sensor which will operate with the resultant voltage. If a sensor requires 24 V, it is necessary to lower power supply voltage for the sensor slightly or secure a power supply for sensor separately without going through the SI unit so that the sensor input voltage can be 24 V with actual loading (allowable voltage of power supply: 19.2 V to 28.8 V).

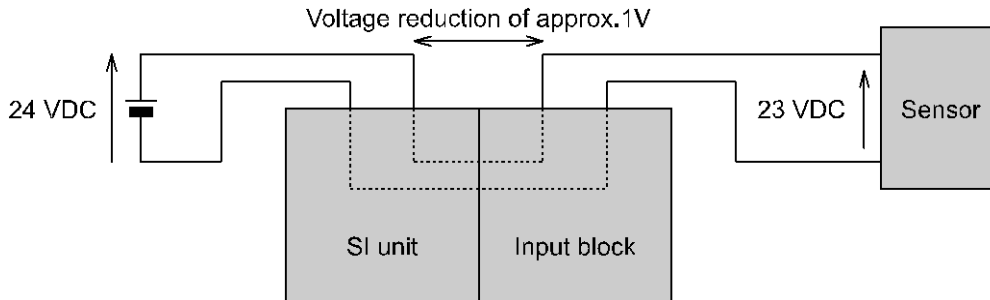

○Ground Terminal

Connect the ground terminal to ground.

Resistance to ground should be 100 ohms or less.

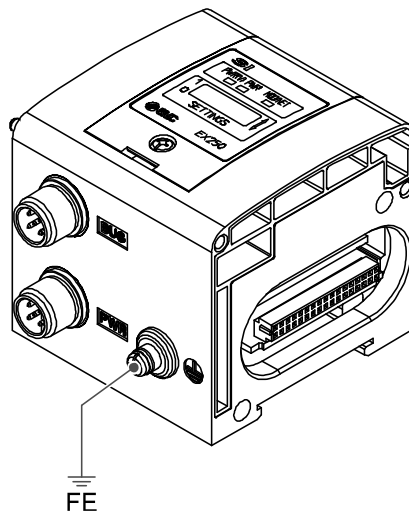

○Maintenance

Addition of Input Block

- Remove screws from End Plate.
- Mount attached tie-rod.
- Connect additional Input Block.
- Connect End Plate and tighten removed screws by specified tightening torque. (0.6 N•m)

Exchange of SI unit

- Remove screws from End Plate and release connection of each unit.
- Replace old SI unit with new one. (Tie-rod does not need to be removed.)
- Connect End Plate and tighten removed screws by specified tightening torque. (0.6 N•m)

Caution for maintenance

- (1) Be sure to turn-off all power supplies.
 - (2) Be sure that there is no foreign object in any of the units.
 - (3) Be sure that the gasket is aligned properly.
 - (4) Be sure that the tightening torque is according to specification.
- If these items are not adhered to, it may lead to damage to the unit or intrusion of liquid or dust into the units.

○Assembly and disconnection of unit

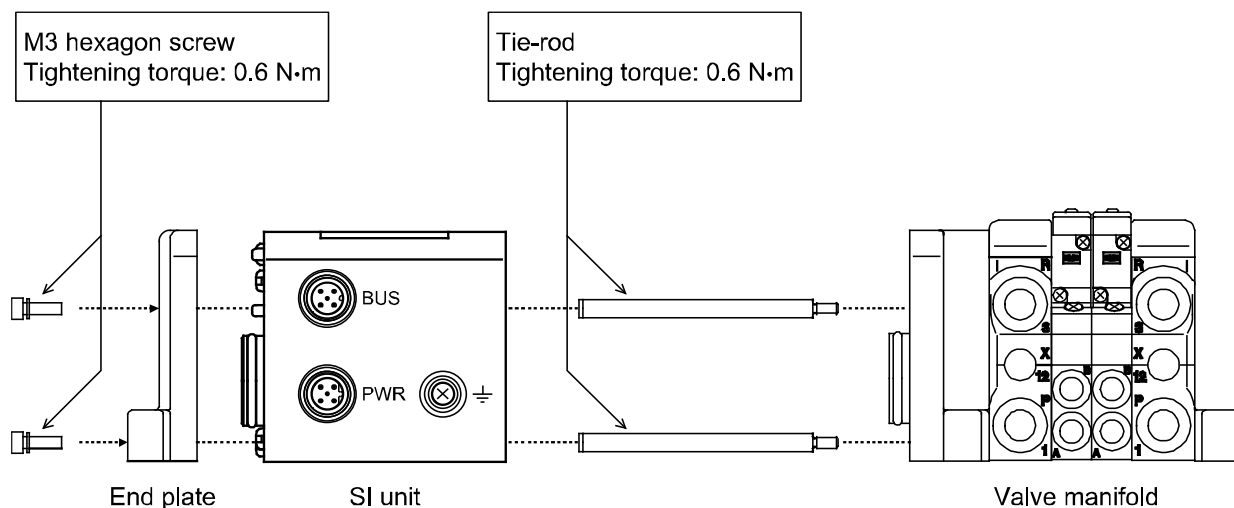

Setting

oLED display

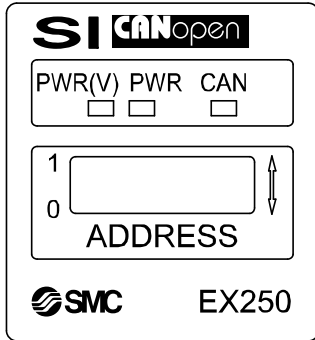

Indication	Contents	
PWR(V)	Green Light	Illuminates when power for solenoid valves is supplied.
PWR	Green Light	Illuminates when power for CANopen line is supplied.
CAN	Green Light	Illuminates when SI unit is in the Operational state.
	Green Light (blinking)	SI unit is in the Pre-Operational state.
	Green Light (single flash)	Single flash when SI unit is in Stopped state.
	Red Light (single flash)	Single flash when CAN controller error occurs.
	Red Light (double flash)	Double flash when Error Control Event occurs.
	Green / Red Light (flickering)	Flickering when SI unit is in Configuration mode. (LSS services)
	Red Light	SI unit is in "Bus OFF" state.

Green (Blinking): Pre-Operational State

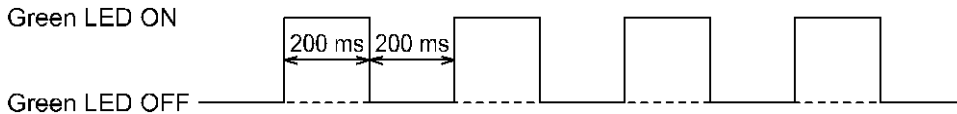

Green (Single Flash): Stopped State

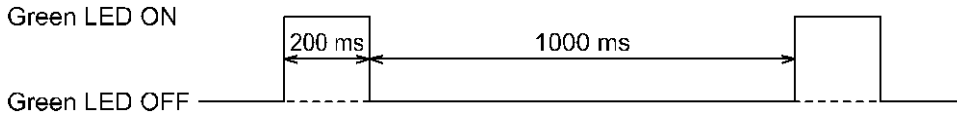

Red (Single Flash): CAN Controller Error

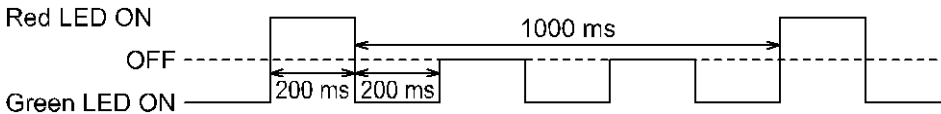

Red (Double Flash): Error Control Event

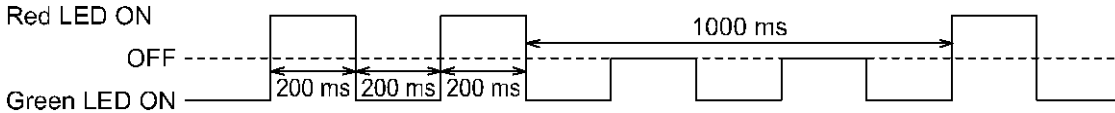

Green/Red (Flickering): LSS Configuration Mode

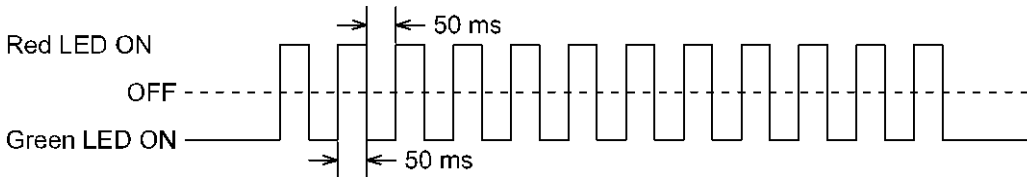

*: LED Indication of SI unit is based on CANopen Specification (CANopen Spec.DR-303-3).

○Switch setting

Before setting of Node-ID by DIP switch, turn "OFF" the power supply to the SI unit.

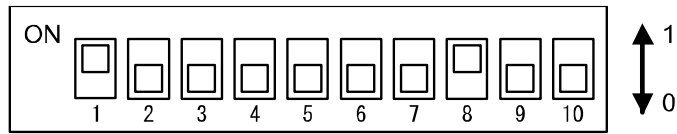

Setting of Node-ID

Node-ID	SW1	SW2	SW3	SW4	SW5	SW6
0	0	0	0	0	0	0
1	1	0	0	0	0	0
2	0	1	0	0	0	0
⋮						
62	0	1	1	1	1	1
63	1	1	1	1	1	1

Set SW7 to 0. (SW7 is not used.)

Set SW8 to 1. (fixed)

Setting of output when communication stops

SW9	Output condition of solenoid valve when "Stop Remote Node" command is received or stopped state by an error occurs (Error Control, Emergency Object). The object 1029h specifies to which state this unit shall be set, when an error is detected.
0	Output Value shall take the pre-defined condition specified in Error Value Output Object (6207h,6307h,6327h) Default: all outputs are cleared.
1	Output Value shall be kept.

Setting of mode

SW10	Mode
0	HW mode. Setting of Node-ID is achieved by DIP switches SW1-6.
1	SW mode. Setting of Node-ID is achieved via network. SW1-8 become unavailable. Node-ID can be set up to 127. Default is 127 (7Fh).

■ Setting of baud rate (Communication speed)

The baud rate can be set in the HW mode by the following methods

○ Method of setting baud rate to value within CiA specification

- (1) Turn OFF the power supply (for CANopen line) and set Node-ID to 0 with DIP switches SW1 to 6.
- (2) CAN LED will blink RED for five seconds when the power supply is returned to SI unit.
- (3) Set DIP switch SW6 to 1 (ON) while CAN LED is blinking (within five seconds).
- (4) CAN LED will stop blinking. Set the baud rate with DIP switches SW1 to 4 within ten seconds as shown in the table below.
- (5) After ten seconds, the CAN LED blinks RED for two seconds when setting is successful.
- (6) After that, the CAN LED will blink slowly RED for five seconds to acknowledge the end of the setting procedure.
- (7) Then, the CAN LED will light GREEN and RED alternately.
- (8) Turn OFF the power supply, set Node-ID, then turn ON the power supply again.
- (9) The CAN LED will illuminate GREEN. The SI units state of communication is standby (when SI unit is in stand by mode, pre-operational).

Baud rate Table

Baud rate	SW1	SW2	SW3	SW4
1000	0	0	0	0
800	1	0	0	0
500	0	1	0	0
250	1	1	0	0
125	0	0	1	0
-	1	0	1	0
50	0	1	1	0
20	1	1	1	0

*: CAN LED illuminates RED when an invalid combination is set with DIP switches SW1 to 4.

○ Method of re-setting to default baud rate (125 kbps)

- (1) Turn off the power supply (for CANopen line) and set Node-ID to 0 with DIP switches SW1 to 6.
- (2) The CAN LED will blink RED for five seconds when the power supply to the SI unit is restored.
- (3) The baud rate is set to 125kbps and the CAN LED illuminates green and red alternately.
- (4) Turn off the power supply, set Node-ID, and turn on the power supply again.
- (5) The CAN LED illuminates (GREEN). The SI units state of communication is standby (when SI unit is in stand by mode, pre-operational).

■ Overview object dictionary for communication object area

Index	Sub-Index	Object	Name	Type	Acc	Default
1000		VAR	device type	Unsigned32	ro	
1001		VAR	error register	Unsigned8	ro	
1002		VAR	manufacturer status register	Unsigned32	ro	
1003		ARRAY	pre-defined error register	Unsigned32	ro	
	0	VAR	number of errors	Unsigned8	rw	00h
	1	VAR	standard error field	Unsigned32	ro	
	2 to 8	VAR	standard error field	Unsigned32	ro	
1005		VAR	COB-ID SYNC	Unsigned32	rw	00000080h
1006		VAR	communication cycle period	Unsigned32	rw	00000000h
1008		VAR	manufacturer device name	Vis-String	const	
1009		VAR	manufacturer hardware version	Vis-String	const	
100A		VAR	manufacturer software version	Vis-String	const	
100C		VAR	guard time	Unsigned16	rw	0000h
100D		VAR	life time factor	Unsigned8	rw	00h
1010		ARRAY	store parameters	Unsigned32	rw	
	0	VAR	largest Sub-Index supported	Unsigned8	ro	
	1	VAR	save all parameters	Unsigned32	rw	
1011		ARRAY	restore default parameters	Unsigned32	rw	
	0	VAR	largest Sub-Index supported	Unsigned8	ro	
	1	VAR	restore all default parameters	Unsigned32	rw	
1014		VAR	COB-ID EMCY	Unsigned32	ro	
1016		ARRAY	Consumer heartbeat time	Unsigned32	rw	
	0	VAR	number of entries	Unsigned8	ro	
	1	VAR	Consumer heartbeat time	Unsigned32	rw	00000000h
	2 to 9	VAR	Consumer heartbeat time	Unsigned32	rw	00000000h
1017		VAR	Producer heartbeat time	Unsigned16	rw	0000h
1018		RECORD	identity object	Identity(0023h)	ro	
	0	VAR	number of entries	Unsigned8	ro	
	1	VAR	vender ID	Unsigned32	ro	
	2	VAR	product code	Unsigned32	ro	
	3	VAR	revision number	Unsigned32	ro	
	4	VAR	serial number	Unsigned32	ro	
1029		ARRAY	Error behavior	Unsigned8	rw	
	0	VAR	Highest Sub-Index supported	Unsigned8	ro	
	1	VAR	Communication error	Unsigned8	rw	82h
Server SDO Parameter						
1200		RECORD	1st server SDO parameter	SDO Parameter(22h)	ro	
	0	VAR	number of entries	Unsigned8	ro	
	1	VAR	COB-ID client->server	Unsigned32	ro	\$NODEID+600h
	2	VAR	COB-ID server->client	Unsigned32	ro	\$NODEID+580h
Receive PDO Communication Parameter						
1400		RECORD	1st receive PDO parameter	PDO CommPar(20h)	ro	
	0	VAR	largest Sub-Index supported	Unsigned8	ro	
	1	VAR	COB-ID used by PDO	Unsigned32	rw	\$NODEID+200h
	2	VAR	transmission type	Unsigned8	rw	FFh

ro = read only access rw = read and write access const = read only access, value is constant

Index	Sub-Index	Object	Name	Type	Acc	Default
Receive PDO Mapping Parameter						
1600		RECORD	1st receive PDO mapping	PDO Mapping(21h)	rw	
	0	VAR	number of mapped application objects in PDO	Unsigned8	rw	04h
	1	VAR	PDO mapping for the 1st application object to be mapped	Unsigned32	rw	62000108h
	2	VAR	PDO mapping for the 2nd application object to be mapped	Unsigned32	rw	62000208h
	3	VAR	PDO mapping for the 3rd application object to be mapped	Unsigned32	rw	62000308h
	4	VAR	PDO mapping for the 4th application object to be mapped	Unsigned32	rw	62000408h
	5	VAR	PDO mapping for the 5th application object to be mapped	Unsigned32	rw	
	6	VAR	PDO mapping for the 6th application object to be mapped	Unsigned32	rw	
	7	VAR	PDO mapping for the 7th application object to be mapped	Unsigned32	rw	
	8	VAR	PDO mapping for the 8th application object to be mapped	Unsigned32	rw	
Transmit PDO Communication Parameter						
1800		RECORD	1st transmit PDO parameter	PDO CommPar(20h)	ro	
	0	VAR	largest Sub-Index supported	Unsigned8	ro	05h
	1	VAR	COB-ID used by PDO	Unsigned32	rw	\$NODEID+180h
	2	VAR	transmission type	Unsigned8	rw	FFh
	3	VAR	Inhibit time	Unsigned16	rw	0000h
	5	VAR	Event timer	Unsigned16	rw	0000h
Transmit PDO Mapping Parameter						
1A00		RECORD	1st transmit PDO mapping	PDO Mapping(21h)	rw	
	0	VAR	number of mapped application objects in PDO	Unsigned8	rw	04h
	1	VAR	PDO mapping for the 1st application object to be mapped	Unsigned32	rw	60000108h
	2	VAR	PDO mapping for the 2nd application object to be mapped	Unsigned32	rw	60000208h
	3	VAR	PDO mapping for the 3rd application object to be mapped	Unsigned32	rw	60000308h
	4	VAR	PDO mapping for the 4th application object to be mapped	Unsigned32	rw	60000408h
	5	VAR	PDO mapping for the 5th application object to be mapped	Unsigned32	rw	
	6	VAR	PDO mapping for the 6th application object to be mapped	Unsigned32	rw	
	7	VAR	PDO mapping for the 7th application object to be mapped	Unsigned32	rw	
	8	VAR	PDO mapping for the 8th application object to be mapped	Unsigned32	rw	

ro=read only access rw = read and write access const= read only access, value is constant

○Index 1000h Device Type

This object describes the type of device and its functionality.
The type of SI unit is as follows.

●General Information

Device profile number: 0191h

●Additional Information

I/O Functionality: 00000011 (Digital Input / Output)

Specific Functionality: 00h (No Specific Function)

○Index 1001h Error Register

This object is an error register for the SI unit .It is a part of an Emergency object.
If Error has occurred, a bit is set to 1.

Bit	Meaning	Content
0	Generic Error	
1	Current	Non-correspondence (always 0)
2	Voltage	Non-correspondence (always 0)
3	Temperature	Non-correspondence (always 0)
4	Communication Error	CAN Over-run, CAN Error, Bus Off
5	Device Profile Specific	Non-correspondence (always 0)
6	Reserved	always 0
7	Manufacturer Specific	Heartbeat, Node Guarding, Self-diagnosis

Structure of the Error Register

○Index 1002h Manufacturer Status Register

This object is used when Self-diagnosis Error for SI unit occurs.
If Error has occurred, a bit is set to 1.

X and Reserved=0								
Reserved	X	X	X	X	DI	SOLV	X	X
31	8	7						0
MSB								LSB

SOLV: When the power supply for the valve is supplied, SOLV Status is 0.

When the power supply for the valve is not supplied, SOLV Status is 1.

DI: When the error of the Input Block occurs (e.g. blow a fuse), DI Status is 1.

When the Input Block is normal, DI Status is 0.

○Index 1003h Pre-defined Error Field

This object holds the errors that have occurred on the SI unit and have been signaled via the Emergency Object.

The entry at Sub-Index 0 describes the number of errors that have been stored.

Every new error is stored at Sub-Index 1, the older ones move down the list.

If 0 is written at the Sub-Index 0, error history is deleted.

Values higher than 0 are prevented from being written.

○Index 1005h COB-ID SYNC message

This object defines the COB-ID of the Synchronization Object (SYNC).

Bit number	Value	meaning
31 (MSB)	X	do not care
30	0	Device does not generate SYNC message *
	1	Device generate SYNC message
29	0	11 bit ID (CAN 2.0A) *
	1	29 bit ID (CAN 2.0B)
28 to 11	0	if bit 29 = 0 *
	X	If bit 29 = 1: bits 28 to 11 of 29-bit-SYNC-COB-ID
10 to 0 (LSB)	X	bits 10 to 0 of SYNC-COB-ID

*: The default values when the SI unit is supplied.

Bits 29 to 11 are fixed (not changeable).

As an example, if an attempt is made to set bit 29 to 1, the SI unit will respond with an abort message.

○Index 1006h Communication Cycle period

When bit 30 of Index 1005h (COB-ID SYNC) is set to 1 (SYNC, Producer), the SYNC message is transmitted at intervals set to this object.

The time can be set in multiples of 1us.

○Index 100Ch Guard Time

Refer to 7-8. Index 100Dh Life Time Factor.

○Index 100Dh Life Time Factor

The Life Time for the Life Guarding Protocol is given by multiplying Guard Time and Life Time Factor.

SI unit supports Node/Life Guarding Protocol by setting Index 100C and Index 100D.

If these objects are set to 0, SI unit does not support Node/Life Guarding Protocol.

These objects are set the time in multiples of 1 ms.

○Index 1010h Store parameters

The various parameters can be saved in internal EEPROM of the SI unit by using this object.

The parameters that can be saved in internal EEPROM of the SI unit are as follows:-

Index	Sub-Index	Name
1005		COB-ID, SYNC
1006		Communication cycle period
100C		guard time
100D		life time factor
1016	1 to 9	Consumer heartbeat time
1017		Producer heartbeat time
1029	1	Communication error
1400	1 to 2	1st receive PDO parameter
1600	0 to 8	1st receive PDO mapping
1800	1 to 3,5	COB-ID used by PDO
1A00	0 to 8	1st transmit PDO mapping
6206	1 to 4	Error Mode Output 8-bit
6207	1 to 4	Error Value Output 8-bit
6306	1 to 2	Error Mode Output 16-bit
6307	1 to 2	Error Value Output 16-bit
6326	1	Error Mode Output 32-bit
6327	1	Error Value Output 32-bit

Object that can be written by "Store parameters".

○Index 1011h Restore Default parameters

The values in the internal EEPROM of the SI unit can be restored to their default values by using this object.

A list of objects that can be restored to default values is mentioned.

(Refer to table: object that can be written by "store parameters").

*: The default values become valid after the SI unit is reset (reset node, reset communication) or the power cycled.

ROM = Read Only Memory, data can not be modified. (R)
 EEPROM = Memorize data although power is off. (R/W)
 RAM = Actual memory the SI-unit is working with. (R/W).

1. Reset node, Reset com or Power cycle: -
EEPROM is copied into RAM
2. STORE: -
Copy RAM (with modified/non - modified values) into EEPROM
3. RESTORE: -
Copy ROM (manufactures origin values) to EEPROM then copy EEPROM to RAM

*: Index 1010h, 1011h

Never turn off the power supply of the unit when you save the parameters to internal EEPROM.

When the parameters are saved internal EEPROM, the unit will be damaged by turning off the power supply.

To save the parameter to internal EEPROM, necessary time is about 1 sec.

○Index 1014h COB-ID Emergency Object

This object defines the COB-ID of the Emergency Object (EMCY).

Bit number	Value	Meaning
31 (MSB)	0	EMCY exists (is valid) *
	1	EMCY does not exist (is not valid)
30	0	Reserved
29	0	11 bit ID (CAN 2.0 A) *
	1	29 bit ID (CAN 2.0 B)
28 to 11	0	if bit 29 = 0 *
	X	if bit 29 = 1: bits 28 to 11 of 29-bit-COB-ID
10 to 0 (LSB)	X	bits 10 to 0 of COB-ID

*: The default values when the SI unit is supplied.

○Index 1016h Consumer Heartbeat Time

The Consumer Heartbeat Time is defined in this object.

The time can be set in multiples of 1ms.

If the Consumer Heartbeat Time is 0, SI unit does not support Consumer Heartbeat.

○Index 1017h Producer Heartbeat Time

The Producer Heartbeat Time is defined in this object.

The time can be set in multiples of 1 ms.

It should be noted that if a time of 100 ms or less is set in this object, the SI unit responds with an abort message.

*: This object cannot be set to a time of 100 ms or less.

○Index 1029h Error Behavior

The Status of the SI unit when a communication error occurs (Error control, Emergency object) is defined in this object.

Index1029h Sub-Index1 defines the error class value.

Value	Description
00h	Change to NMT state Pre-operational (Only if currently in NMT state Operational)
01h	No change of the NMT state
02h	Change to NMT state Stopped
03h to 80h	Reserved
81h	No change of the NMT state (Even if the unit receives a "Restore Default Parameters" command, this value maintains 81h)
82h	Change to NMT state Stopped * (Even if the unit receives a "Restore Default Parameters" command, this value maintains 82h)
83h to FFh	Reserved

*: The default values when the SI unit is supplied.

When the "Store Parameters" command is executed, the set value is recorded to the EEPROM in the SI unit.

Set the error class value to 02h or 82h and set the DIP switch SW9 to 0 (OFF) to stop the operation when communication error occurs.

○Index 1200h Server SDO Parameter

Bit number	Value	Meaning
31 (MSB)	0	SDO exists (is valid) *
	1	SDO does not exists (is not valid)
30	0	Reserved (always 0)
29	0	11 bit ID (CAN 2.0 A) *
	1	29 bit ID (CAN 2.0 B)
28 to 11	0	if bit 29 = 0 *
	X	if bit 29 = 1: bits 28 to 11 of 29-bit-COB-ID
10 to 0 (LSB)	X	bits 10 to 0 of COB-ID

*: The default values when the SI unit is supplied.

○Index 1400h Receive PDO Communication Parameter

Index1400h_Sub-Index1 means COB-ID of PDO.

Bit number	Value	Meaning
31 (MSB)	0	PDO exists (is valid) *
	1	PDO does not exist (is not valid)
30	0	RTR allowed on this PDO *
	1	no RTR allowed on this PDO
29	0	11 bit ID (CAN 2.0 A) *
	1	29 bit ID (CAN 2.0 B)
28 to 11	0	if bit 29 = 0 *
	X	if bit 29 = 1: bits 28 to 11 of 29-bit-COB-ID
10 to 0 (LSB)	X	bits 10 to 0 of COB-ID of PDO

*: The default values when the SI unit is supplied.

○Index1400h_Sub-Index2 means transmission type of PDO.

Transmission type	Meaning
0 to 240	When the next SYNC message is received, the PDO data is processed. The value of the transmission type is irrelevant.
241 to 253	No used
254	It is the same as 255. (It differs according to the manufacturer).
255 (default)	When the PDO data is received, the data is processed at once.

○Index 1600h Receive PDO Mapping Parameter

Sub-Index0: Number of mapped application objects in PDO.

Sub-Index1 to 8: The Sub-Index (from 1h to number of entries) contain the information about the mapped application variables.

*: When SI unit is shipped, the mapping is done from Sub-Index1 to Sub-Index4.

The structure of the entries from Sub-Index 1 to 8 is as follows:-

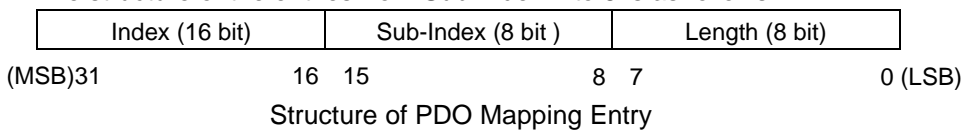

○Index 1800h Transmit PDO Communication Parameter

Index1800h_Sub-Index1 means COB-ID of PDO.

Bit number	Value	Meaning
31 (MSB)	0	PDO exists (is valid) *
	1	PDO does not exist (is not valid)
30	0	RTR allowed on this PDO *
	1	no RTR allowed on this PDO
29	0	11 bit ID (CAN 2.0 A) *
	1	29 bit ID (CAN 2.0 B)
28 to 11	0	if bit 29=0 *
	X	if bit 29=1: bits 28 to 11 of 29-bit-COB-ID
10 to 0 (LSB)	X	bits 10 to 0 of COB-ID of PDO

*: The default values when the SI unit is supplied.

Index1800h_Sub-Index2 means transmission type of PDO.

Transmission type	Meaning
0	When the next SYNC message is received, the PDO data is transmitted.
1 to 240 (N)	When the SYNC message of time N is received, the PDO data is transmitted.
241 to 251	Not used
252	When the next SYNC message is received, the PDO is not transmitted though the PDO data is updated. When RTR is received, the PDO is transmitted.
253	When RTR is received, the PDO data is transmitted.
254	It is the same as 255 (It differs according to the manufacturer).
255 (default)	When the PDO data is updated, the data is transmitted at once.

Index1800h_Sub-Index3 means inhibit time.

The time can be set in multiples of 100us.

Index1800h_Sub-Index5 means event timer.

The time can be set in multiples of 1ms.

○Index 1A00h Transmit PDO Mapping Parameter

Sub-Index0: Number of mapped application objects in PDO.

Sub-Index1 to 8: The Sub-Index (from 1h to number of entries) contain the information about the mapped application variables.

*: When SI unit is shipped, the mapping is done from Sub-Index1 to Sub-Index4.

The structure of the entries from Sub-Index 1 to 8 is as follows.

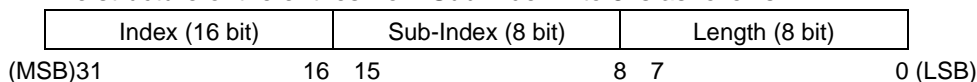

Structure of PDO Mapping Entry

■ Overview object dictionary for manufacturer specific area

Index	Sub-Index	Object	Name	Type	Acc	Default
2000		VAR	Reserve	Unsigned32	ro	
2001		VAR	Password	Unsigned16	wo	

ro=read only access wo=write only access

○ Index 2000h Reserve

This object is not used.

○ Index 2001h Password

This object is a manufacturing password so is not supplied to the user.

*: For making sure that the machine works fine, the machine builder is responsible.

As for CANopen unit made of each maker, the ability (Minimum message interval) is different respectively.

The machine builder should consider the difference of the ability.

Method (confirmed service) of sending the following request after the response to the request is received to communicate surely is recommended.

When you use method (unconfirmed service) of sending the following request without receiving the response to the request, If the request which exceeds the processing performance of each unit is sent, it is not treatable.

Please confirm the normal operation beforehand when our unit is used for your machine.

Please consult our company when there is a problem.

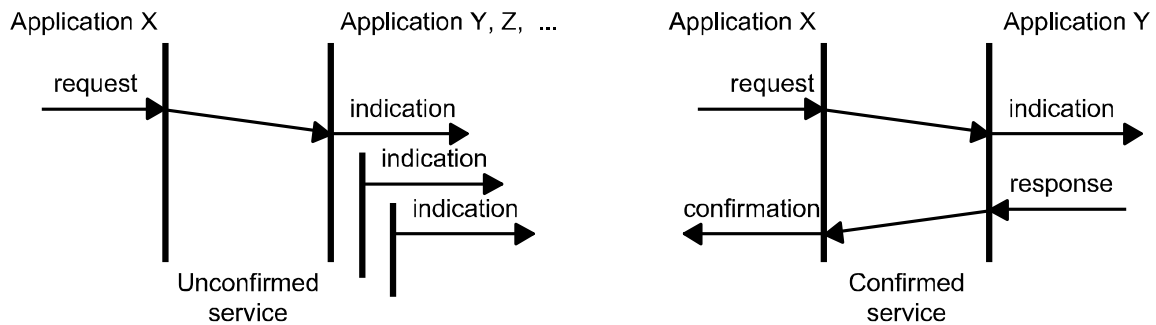

■ Overview object dictionary for device profile specific area

Index	Sub-Index	Object	Name	Type	Acc	Default
Digital Input Module						
6000		ARRAY	Read Inputs 8-bit			
	0	VAR	Number of inputs 8-bit	Unsigned8	ro	
	1	VAR	Read Inputs 1h to 8h	Unsigned8	ro	
	2	VAR	Read Inputs 9h to 16h	Unsigned8	ro	
	3	VAR	Read Inputs 17h to 24h	Unsigned8	ro	
	4	VAR	Read Inputs 25h to 32h	Unsigned8	ro	
6100		ARRAY	Read Inputs 16-bit			
	0	VAR	Number of inputs 16-bit	Unsigned8	ro	
	1	VAR	Read Inputs 1h to 16h	Unsigned16	ro	
	2	VAR	Read Inputs 17h to 32h	Unsigned16	ro	
6120		ARRAY	Read Inputs 32-bit			
	0	VAR	Number of inputs 32-bit	Unsigned8	ro	
	1	VAR	Read Inputs 1h to 32h	Unsigned32	ro	
Digital Output Module						
6200		ARRAY	Write Outputs 8-bit			
	0	VAR	Number of outputs 8-bit	Unsigned8	ro	
	1	VAR	Write Outputs 1h to 8h	Unsigned8	rw	00h
	2	VAR	Write Outputs 9h to 16h	Unsigned8	rw	00h
	3	VAR	Write Outputs 17h to 24h	Unsigned8	rw	00h
	4	VAR	Write Outputs 25h to 32h	Unsigned8	rw	00h
6206		ARRAY	Error Mode Outputs 8-bit			
	0	VAR	Number of outputs 8-bit	Unsigned8	ro	
	1	VAR	Error Mode Outputs 1h to 8h	Unsigned8	rw	FFh
	2	VAR	Error Mode Outputs 9h to 16h	Unsigned8	rw	FFh
	3	VAR	Error Mode Outputs 17h to 24h	Unsigned8	rw	FFh
	4	VAR	Error Mode Outputs 25h to 32h	Unsigned8	rw	FFh
6207		ARRAY	Error Value Outputs 8-bit			
	0	VAR	Number of outputs 8-bit	Unsigned8	ro	
	1	VAR	Error Value Outputs 1h to 8h	Unsigned8	rw	00h
	2	VAR	Error Value Outputs 9h to 16h	Unsigned8	rw	00h
	3	VAR	Error Value Outputs 17h to 24h	Unsigned8	rw	00h
	4	VAR	Error Value Outputs 25h to 32h	Unsigned8	rw	00h
6300		ARRAY	Write Outputs 16-bit			
	0	VAR	Number of outputs 16-bit	Unsigned8	ro	
	1	VAR	Write Outputs 1h to 16h	Unsigned16	rw	0000h
	2	VAR	Write Outputs 17h to 32h	Unsigned16	rw	0000h
6306		ARRAY	Error Mode Outputs 16-bit			
	0	VAR	Number of outputs 16-bit	Unsigned8	ro	
	1	VAR	Error Mode Outputs 1h to 16h	Unsigned16	rw	FFFFh
	2	VAR	Error Mode Outputs 17h to 32h	Unsigned16	rw	FFFFh

ro=read only access rw=read and write access

Index	Sub-Index	Object	Name	Type	Acc	Default
Digital Output Module						
6307		ARRAY	Error Value Outputs 16-bit			
	0	VAR	Number of outputs 16-bit	Unsigned8	ro	
	1	VAR	Error Value Outputs 1h to 16h	Unsigned16	rw	0000h
	2	VAR	Error Value Outputs 17h to 32h	Unsigned16	rw	0000h
6320		ARRAY	Write Outputs 32-bit			
	0	VAR	Number of outputs 32-bit	Unsigned8	ro	
	1	VAR	Write Outputs 1h to 32h	Unsigned32	rw	00000000h
6326		ARRAY	Error Mode Outputs 32-bit			
	0	VAR	Number of outputs 32-bit	Unsigned8	ro	
	1	VAR	Error Mode Outputs 1h to 32h	Unsigned32	rw	FFFFFFFFh
6327		ARRAY	Error Value Outputs 32-bit			
	0	VAR	Number of outputs 32-bit	Unsigned8	ro	
	1	VAR	Error Value Outputs 1h to 32h	Unsigned32	rw	00000000h

ro=read only access rw=read and write access

○Index 6000h Read Inputs 8-

This object shall read groups of 8 input lines as 8-bit information.

Sub-Index 0: Number of Inputs 8-Bit (Number of Sub-Index)

Sub-Index 1: Input Data 0 to 7th Bit

Sub-Index 2: Input Data 8 to 15th Bit

Sub-Index 3: Input Data 16 to 23rd Bit

Sub-Index 4: Input Data 24 to 31st Bit

○Index 6100h Read Inputs 16-Bit

This object shall read a group of 16 input lines as 16-bit information.

Sub-Index 0: Number of Inputs 16-Bit (Number of Sub-Index)

Sub-Index 1: Input Data 0 to 15th Bit

Sub-Index 2: Input Data 16 to 31st Bit

○Index 6120h Read Inputs 32-Bit

This object shall read a group of 32 input lines as 32-bit information.

Sub-Index 0: Number of Inputs 32-Bit (Number of Sub-Index)

Sub-Index 1: Input Data 0 to 31st Bit

○Index 6200h Write Outputs 8-Bit

This object shall set a group of 8 output lines as 8-bit information.

Sub-Index 0: Number of Outputs 8-Bit (Number of Sub-Index)

Sub-Index 1: Output Data 0 to 7th Bit

Sub-Index 2: Output Data 8 to 15th Bit

Sub-Index 3: Output Data 16 to 23rd Bit

Sub-Index 4: Output Data 24 to 31st Bit

○Index 6206h Error Mode Outputs 8-Bit

This object indicates whether an output is set to a pre-defined error value when stopped state.

1 = the output value shall be set to the pre-defined condition specified in the 6207h object

0 = the output value shall be retained

The value in the EEPROM (Index 6206h) depends on the status of DIP Switch SW9

If DIP switch SW9 is 0 (OFF), the value of Index 6206h is FFh. (This is default value)

If DIP switch SW9 is 1 (ON), the value of Index 6206h is 00h.

However, if the value of Index 6206h is changed and "Store Parameters" is executed, the set value is saved in internal EEPROM of the SI unit. After that the SI unit will use this value until the default value of FFh is set or a "Restore default parameters" is executed.

*: If "Store Parameters" is not executed when the value of Index 6206h is changed, the value is not saved in internal EEPROM of SI unit.

Sub-Index 0: Number of Outputs 8-Bit (Number of Sub-Index)

Sub-Index 1: Error Mode Output Data 0 to 7th Bit

Sub-Index 2: Error Mode Output Data 8 to 15th Bit

Sub-Index 3: Error Mode Output Data 16 to 23rd Bit

Sub-Index 4: Error Mode Output Data 24 to 31st Bit

○Index 6207h Error Value Outputs 8-Bit

When DIP switch SW9 is set to 0 or the value of Index 6206h is 1, the SI unit will reflect the value of Index 6207h.

0=Output will be set to 0. (Output clear)

1=Output will be set to 1. (Output on)

○Index 6300h Write Outputs 16-Bit

This object shall set a group of 16 output lines as 16-Bit information.

Sub-Index 0: Number of Outputs 16-Bit (Number of Sub-Index)

Sub-Index 1: Output Data 0 to 15th Bit

Sub-Index 2: Output Data 16 to 31st Bit

○Index 6306h Error Mode Outputs 16-Bit

This object indicates whether an output is set to a pre-defined error value when stopped state.

1=the output value shall be set to the pre-defined condition specified in the 6307h object

0=the output value shall be retained

The SI unit reflects the status of the DIP switch SW9 when the value of the index 6306h in the internal EEPROM of the SI unit is FFFFh (default).

If DIP switch SW9 is 0 (OFF), the value of Index 6306h is FFFFh. (This is default value)

If DIP switch SW9 is 1 (ON), the value of Index 6306h is 0000h.

If the value of Index 6306h is changed and "Store Parameters" is executed, the set value is saved in the internal EEPROM of the SI unit. After this, the SI unit operates by setting a value until the value of Index 6306h is set to the default value (FFFFh) or "Restore default parameters" is executed.

*: If "Store Parameters" is not executed when the value of Index 6306h is changed, the value is not saved in internal EEPROM of SI unit.

Sub-Index 0: Number of Outputs 16-Bit (Number of Sub-Index)

Sub-Index 1: Error Mode Output Data 0 to 15th Bit

Sub-Index 2: Error Mode Output Data 16 to 31st Bit

○Index 6307h Error Value Outputs 16-Bit

When DIP switch SW9 is set to 0 or the value of Index 6306h is 1, the SI unit reflects the value of Index 6307h.

0=The output shall be set to 0. (Output clear)

1=The output shall be set to 1. (Output on)

○Index 6320h Write Outputs 32-Bit

This object shall set a group of 8 outputs lines as 32-Bit of information.

Sub-Index 0: Number of Outputs 32-Bit (Number of Sub-Index)

Sub-Index 1: Output Data 0 to 31st Bit

○Index 6326h Error Mode Outputs 32-Bit

This object indicates whether an output is set to a pre-defined error value when stopped state.

1=the output value shall be set to the pre-defined condition specified in the 6327h object

0=the output value shall be retained.

The SI unit reflects the status of the DIP switch SW9 when the value of Index 6326h in internal EEPROM of SI unit is default (FFFFFFFFh).

If DIP switch SW9 is 0 (OFF), the value of Index 6326h is FFFFFFFFh. (This is default value)

If DIP switch SW9 is 1 (ON), the value of Index 6326h is 00000000h.

If the value of Index 6326h is changed and "Store Parameters" is executed, the set value is saved in the internal EEPROM of the SI unit.

After that, the SI unit operates by setting the value until the value of Index 6326h is set to the default value (FFFFFFFFh) or "Restore default parameters" is executed.

*: If "Store Parameters" is not executed when the value of Index 6326h is changed, the value is not saved in internal EEPROM of SI unit.

Sub-Index 0: Number of Outputs 32-Bit (Number of Sub-Index)

Sub-Index 1: Error Mode Output Data 0 to 31st Bit

○Index 6327h Error Value Outputs 32-Bit

When DIP switch SW9 is set to 0 or the value of Index 6326h is 1, SI unit reflects the value of Index 6327h.

0=The output shall be set to 0. (Output clear)

1=The output shall be set to 1. (Output on)

■ Error control services

SI unit supports both Node Guarding Protocol and Heartbeat Protocol.

Node Guarding Protocol can be used by setting Index 100Ch and Index 100Dh Objects.

Heartbeat Protocol can be used by setting Index 1016h and Index 1017h Objects.

Error Control Services are not set on shipment. (100C, 100D, 1016, 1017h=0)

Node Guarding Protocol and Heartbeat Protocol are not able to be used at the same time.

If both Node Guarding Protocol and Heartbeat Protocol are set at the same time, the Heartbeat Protocol is used.

There are the following possibilities:-

The possibilities of Error Control Services	Heartbeat Protocol	Node Guarding	Life Guarding
Heartbeat is configured; Node and Life guarding are also configured	ON	OFF	OFF
Heartbeat is configured; Node and Life guarding are not configured	ON	OFF	OFF
Heartbeat is not configured; Node and Life guarding are configured	OFF	ON	ON
Node guarding is configured; Heartbeat and Life guarding are not configured	OFF	ON	OFF

○ Node Guarding Protocol

This protocol is used to detect remote errors in the network. Each NMT Slave uses one remote COB for the Node Guarding Protocol. This protocol implements the provider initiated Error Control Services.

Life Guarding is set by the Guard Time (Index 100C) multiplied by the Life Time Factor (Index 100D). Life Guarding starts when SI unit receives the first Remote-Transmit-Request (RTR).

If the SI unit does not receive RTR for the Node Life Time, the SI unit will be informed about that event.

(The SI unit sends the Emergency Object).

*: If the Guard Time (Index 100C) and Life Time Factor (Index 100D) are set to 0, the Node Guarding Protocol (Error Control Services) is not set, however, even when neither the Heartbeat Protocol nor Node Guarding Protocol are set, the SI unit returns the response if the SI unit receives RTR.

○ Heartbeat Producer Protocol

The Heartbeat Producer transmits a Heartbeat Message cyclically at the Producer Heartbeat Time (Index 1017h: Producer Heartbeat Time).

○ Heartbeat Consumer Protocol

The Heartbeat Consumer guards the reception of the Heartbeat within the Heartbeat Consumer Time (Index 1016h_Sub-Index1: Consumer Heartbeat Time)

If SI unit does not receive a message by a Heartbeat Producer for the Heartbeat Consumer Time, the SI unit will be informed about that event. (The SI unit sends the Emergency Object).

*: If the Heartbeat Consumer Time (Index 1016h_Sub-Index1) is set to 0, the Heartbeat Protocol (Error Control Services) is not set.

■Emergency object

SI unit sends Emergency Objects when error occurs in SI unit.

Byte	0	1	2	3	4	5	6	7
	Emergency Error Code		Error register Object	Manufacturer specific Error Field				

Structure of the Emergency Object Data

Error code (Hex)	Meaning
0000h	Error Reset (or No Error)
1000h	Generic Error
8110h	CAN Over-run
8120h	CAN in Error Passive Mode
8130h	Life Guard Error or Heartbeat Error
8210h	PDO not processed due to length error

Emergency Error Code

○Error register Object (1001h)

Bit	Meaning	Content
0	Generic Error	
1	Current	Non-correspondence (always 0)
2	Voltage	Non-correspondence (always 0)
3	Temperature	Non-correspondence (always 0)
4	Communication Error	CAN Over-run , CAN Error , Bus Off
5	Device Profile Specific	Non-correspondence (always 0)
6	Reserved	always 0
7	Manufacturer Specific	Heartbeat , Node Guarding , Self-diagnosis

Structure of the Error Register

○Error register Manufacturer specific Error Field

When Self-diagnosis Error occurs, the SI unit puts the error result in bytes 2 and bytes 3 of the Emergency Object and sends to master. Bytes 4 to 7 are always 0.

Bit	Meaning	Content
0	Reserved	always 0
1	Reserved	always 0
2	SOLV	Reflect the status of the power supply for the valve
3	DI	Reflect the status of the Input Block
4	Reserved	always 0
5	Reserved	always 0
6	Reserved	always 0
7	Reserved	always 0

Structure of the Manufacturer specific Error Field

SOLV: When the valve power supply is supplied, SOLV Status becomes 0.

When the valve power supply is not supplied, SOLV Status becomes 1.

DI: When an error occurs in the Input Block (EX250-IE1, 2, 3), DI status becomes 1.

When the Input Block is normal, DI status is 0.

■ Service data object (SDO)

○ SDO Upload

● Initiate SDO Upload

This protocol is used when the size of the data to be uploaded is 4 bytes or less.

When the data size exceeds 4 bytes, the number of uploaded data bytes is transmitted.

● Upload SDO Segment

This protocol is used when the size of the data to upload exceeds 4 bytes.

In this case, the upload data is transmitted by using the "Upload SDO Segment" after executing the "Initiate SDO Upload".

The maximum data size in 1 data frame is 7 Bytes.

When the data size exceeds 7 Bytes, "Upload SDO Segment" has to be executed until all data is sent from the server of the SDO to the client.

○ SDO Download

● Initiate SDO Download

This protocol is used when the size of the data to be downloaded is 4 bytes or less.

When the data size exceeds 4 bytes, the number of downloaded data bytes is transmitted.

● Download SDO Segment

This protocol is used when the size of the data to download exceeds 4 Bytes.

In this case, the download data is transmitted by using the "Download SDO Segment" after executing the "Initiate SDO Download".

The maximum data size in 1 data frame is 7 Bytes.

When the data size exceeds 7 Bytes, "Download SDO Segment" has to be executed until all data is sent from the client of the SDO to the server.

■Abort SDO transfer

The SI unit sends an abort code, which is encoded as an UNSIGNED32 (4 byte data) value. When something wrong is found in the message from the SDO server, the SI unit sends the message which is referred to in the table below.

Abort code	Description
0504 0001h	Client/server command specifier not valid or unknown
0601 0001h	Attempt to read a write only object.
0601 0002h	Attempt to write a read only object.
0602 0000h	Object does not exist in the object dictionary.
0604 0041h	Object cannot be mapped to the PDO.
0604 0043h	General parameter incompatibility reason.
0607 0010h	Data type does not match , length of service parameter does not match
0609 0011h	Sub-Index does not exist.
0609 0030h	Value range of parameter exceeded (only for write access).
0609 0032h	Value of parameter written too low.
0800 0000h	general error
0800 0020h	Data cannot be transferred or stored to the application.
0800 0021h	Data cannot be transferred of stored to the application because of local control.
0800 0022h	Data cannot be transferred or stored to the application because of the present device state.

SDO abort codes

■ Process data object (PDO)

The SI unit receives and outputs the N data bytes that are defined by Object 1600h and 1A00h.

The SI unit returns an Emergency Object (Error Code: 8210h) when the data that the SI unit receives is smaller than N bytes.

SI unit outputs the first N bytes of data as "pertinent data" when the data that the SI unit receives is larger than N bytes.

The SI unit supports Dynamic Mapping and Dummy Entry and variable COB-ID.

When more than two slaves are used with the same COB-ID, Dummy Data may be needed. Dummy entries are only used within the received PDO. The dummy data that can be used with SI unit is shown below.

Index 0005h: Unsigned8

Index 0006h: Unsigned16

Index 0007h: Unsigned32

<For Example>

Slave1 => Node-ID=1, COB-ID for RPDO=420h (Index 1400_Sub1) *default 201h

Slave2 => Node-ID=5, COB-ID for RPDO=420h (Index 1400_Sub1) *default 205h

*: SI unit supports variable COB-ID.

Slave1 Mapping (1600h RPDO Mapping Parameter)

1600h_sub0=2

1600h_sub1=6320 01 20 (Object 6320h Sub-Index 1, length 32-bit)

1600h_sub2=6320 02 20 (Object 6320h Sub-Index 2, length 32-bit)

Slave2 Mapping (1600h RPDO Mapping Parameter)

1600h_sub0=2

1600h_sub1=0007 00 20 (Object 0007h (Unsigned 32) Sub-Index 0, length 32-bit)

1600h_sub2=6320 01 20 (Object 6320h Sub-Index 1, length 32-bit)

PDO Data from Master to each Slaves.

COB-ID	1th_data	2th_data	3th_data	4th_data	5th_data	6th_data	7th_data	8th_data
420h	12	34	56	78	9A	BC	DE	FF

Output status of Slave1 and Slave2

COB-ID	1th_data	2th_data	3th_data	4th_data	5th_data	6th_data	7th_data	8th_data
420h (Slave1)	6320h/01h 32 bit (Output 0 to 31 bit)				6320h/02h 32 bit (Output 32 to 63 bit)			
	12	34	56	78	9A	BC	DE	FF
420h (Slave2)	0007h/00h 32 bit *				6320h/01h 32 bit (Output 0 to 31 bit)			
	Dummy Entry *				12	34	56	78

*: SI unit ignores the first 4-bytes of data (PDO Data from Master).

*: SI unit supports valuable COB-ID, therefore, SI unit can set an arbitrary value, however, if you set COB-ID to SI unit, we recommend to set Unused COB-ID (281h-57Fh) for safety reasons.

Dynamic mapping is only possible in "pre-operational" mode.

■ Pre-defined connection set

COB-Identifier

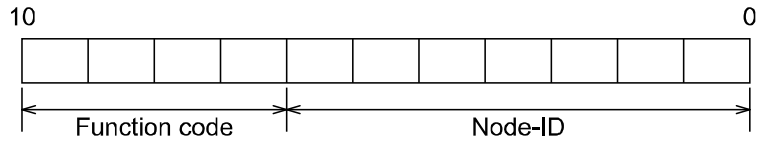

COB-Identifier allocation scheme for the pre-defined Connection set

COB-ID is composed of 11 bits.

The Function Code is allocated in bits 7 to 10 and the Node-ID is allocated in bits 0 to 6.

Object	Function Code	Resulting COB-ID	Communication Parameters at Index
NMT	0000	0	—
SYNC	0001	128 (80h)	1005h
Emergency	0001	129 (81h) to 255 (FFh)	1014h
PDO(tx)	0011	385 (181h) to 511 (1FFh)	1800h
PDO(rx)	0100	513 (201h) to 639 (27Fh)	1400h
SDO(tx)	1011	1409 (581h) to 1535 (5FFh)	1200h
SDO(rx)	1100	1537 (601h) to 1663 (67Fh)	1200h
NMT Error Control	1110	1793 (701h) to 1919 (77Fh)	100Ch,100Dh,1016h,1017h

Objects of the Pre-defined Connection Set

All devices (clients) have to receive and correspond when NMT and SYNC Object are transmitted.

The SI unit can change COB-ID of PDO (tx) and PDO (rx). (Index 1400h_01, Index 1800h_01)

If COB-ID is changed and "Store Parameters" are not executed, SI unit operates according to above-mentioned COB-ID (refer to Objects within Pre-defined Connection Set) at the next Power Supply ON.

*: If "Store Parameters" are not executed, the value is not saved in internal EEPROM of SI unit.

■ Layer setting services (LSS)

SI unit supports LSS function, therefore SI unit supports the following function:-

- Switch Mode Services
- Configuration Services
- Inquiry Services
- Identification Services

Request COB-ID is 2021 (7E5h) in the services.

Response COB-ID is 2020 (7E4h) in the services.

Request and Response COB-ID are all common in this LSS.

○ Switch Mode Services

• Switch Mode Global

This service is used to switch all LSS Slaves in the network between operation mode and configuration mode.

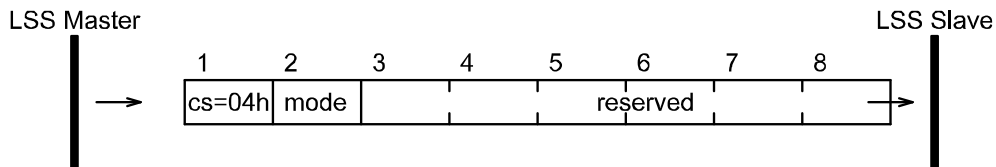

cs: LSS command specifier (04h for Switch Mode Global)

mode: 0= Switches to Operation Mode

1= Switches to Configuration Mode

reserved: reserved for further use by CiA

• Switch Mode Selective

This service is used to switch the LSS Slave whose LSS address attribute equals LSS_address, into configuration mode.

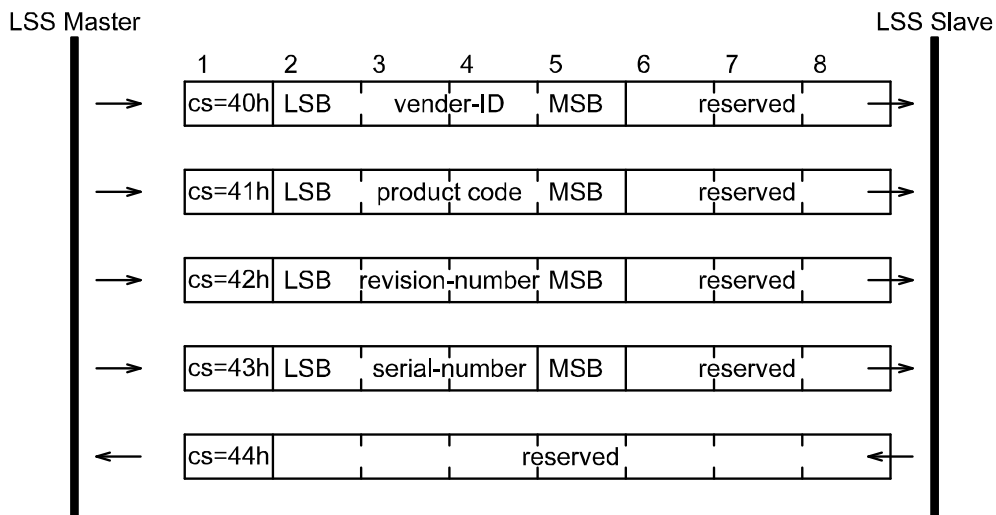

cs: LSS command specifier (40h to 44h for Switch Mode Selective)

vendor-ID: Vendor name. Part of the LSS address (Index 1018h Sub-Index 1)

product-code: Product name. Part of LSS address (Index 1018h Sub-Index 2)

revision-number: Revision. Part of the LSS address (Index 1018h Sub-Index 3)

serial-number: Serial number. Part of the LSS address (Index 1018h Sub-Index 4)

○ Configuration Services

This services are supported only at the SW mode (DipSW10=1).

● Configure Node-ID

This protocol is used to implement the "Configure Node-ID" service for the Node-ID part of NMT address. After switching back to LSS "Operation Mode" to "Configuration Mode" a change of the Node-ID will occur.

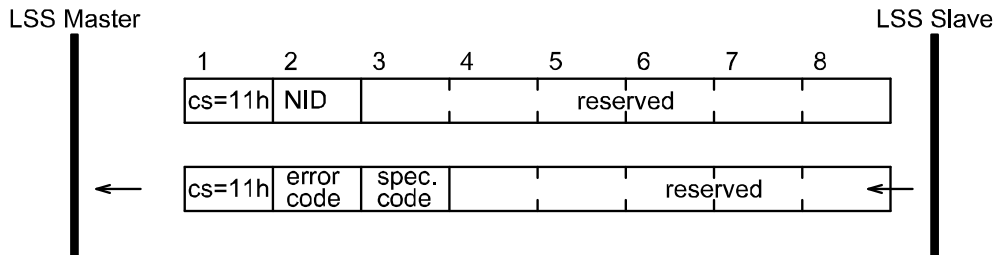

cs: LSS command specifier (11h for Configure Node-ID)

NID: The new Node-ID to configure

error code: 0: protocol successfully completed

1: Node-ID out of range

2 to 254: reserved for further use by CiA

255: implementation specific error occurred (not used)

spec error: not used

● Configure Bit Timing Parameters

The bit Timing of LSS Slave can be changed by this service.

This service allows only one LSS Slave in configuration mode.

The service has to be followed by an "Activate Bit Timing Parameters" service to activate the configured parameters.

After execution of the "Configure Bit Timing Parameters" service the node may not execute any remote LSS services expect the services "Configure Bit Timing Parameters services", "Activate Bit Timing Parameters" and Switch Mode.

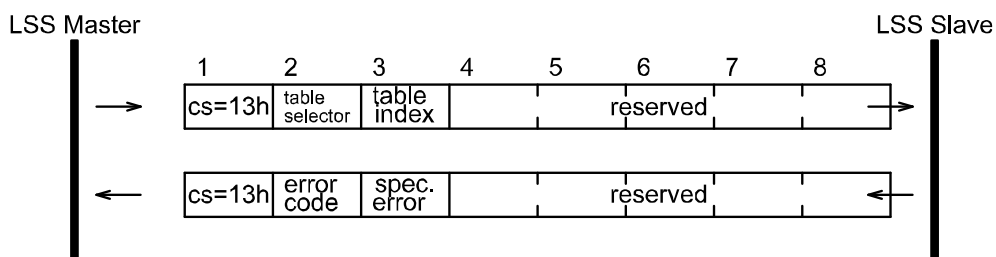

cs: LSS command specifier (13h for Configure Bit Timing Parameters)

table selector: selects which bit timing parameters table has to be used

0: standard CiA bit timing table

1 to 127: reserved for further use by CiA

128 to 255: may be used for manufacturer specific bit timings (not used)

table index: selects the entry (bit timing parameters) in the selected table.

error code: 0: protocol successfully completed
 1: bit timing not supported
 2 to 254: reserved for further use by CiA
 255: implementation specific error occurred (not used)
 spec error: not used

Baud rate	Table Index
1000 kbps	0
800 kbps	1
500 kbps	2
250 kbps	3
125 kbps	4
reserved	5
50 kbps	6
20 kbps	7

oActivate Bit Timing Parameters Protocol

The switch_delay parameter specifies the length of two delay periods of equal length, which are necessary to avoid operating the bus with differing bit timing parameters.
 Each node performs the actual switch of the bit timing parameters after reception of the command (the delay "switch_delay" is in milliseconds). After performing the switch, SI unit does not transmit any message before the second time "switch_delay" has passed.
 This service allows all LSS Slaves in "Configuration Mode".

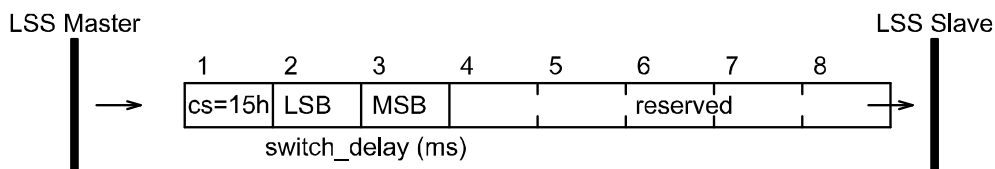

cs: LSS command specifier (15h for Activate Bit Timing Parameters)
 switch delay: The duration of the two periods of time to wait until the bit timing parameters switch is done (first period) and before transmitting any CAN message with the new bit timing parameters after performing the switch (second period).
 The switch_delay is set in multiples of 1 ms.
 reserved: reserved for further use by CiA

oStore Configured Parameters

The configured parameters can be stored in internal EEPROM of SI unit.
 This service allows only one LSS Slave in "Configuration Mode".

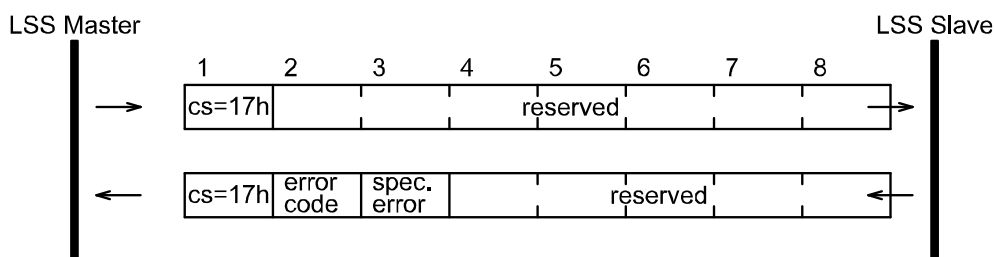

cs: LSS command specifier (17h for Store Configured Parameters)
 error code: 0: protocol successfully completed
 1: store configuration is not supported
 2: storage media access error
 3 to 254: reserved for further use by CiA
 255: implementation specific error occurred (not used)
 specific error code: If error code equals 255, specific error code gives a specific error code (not used)
 reserved: reserved for further use by CiA

○Inquiry Services

These services are supported only in configuration mode.

●Inquire LSS Address

This service allows the determination of the LSS Address parameters of a LSS Slave in configuration mode.

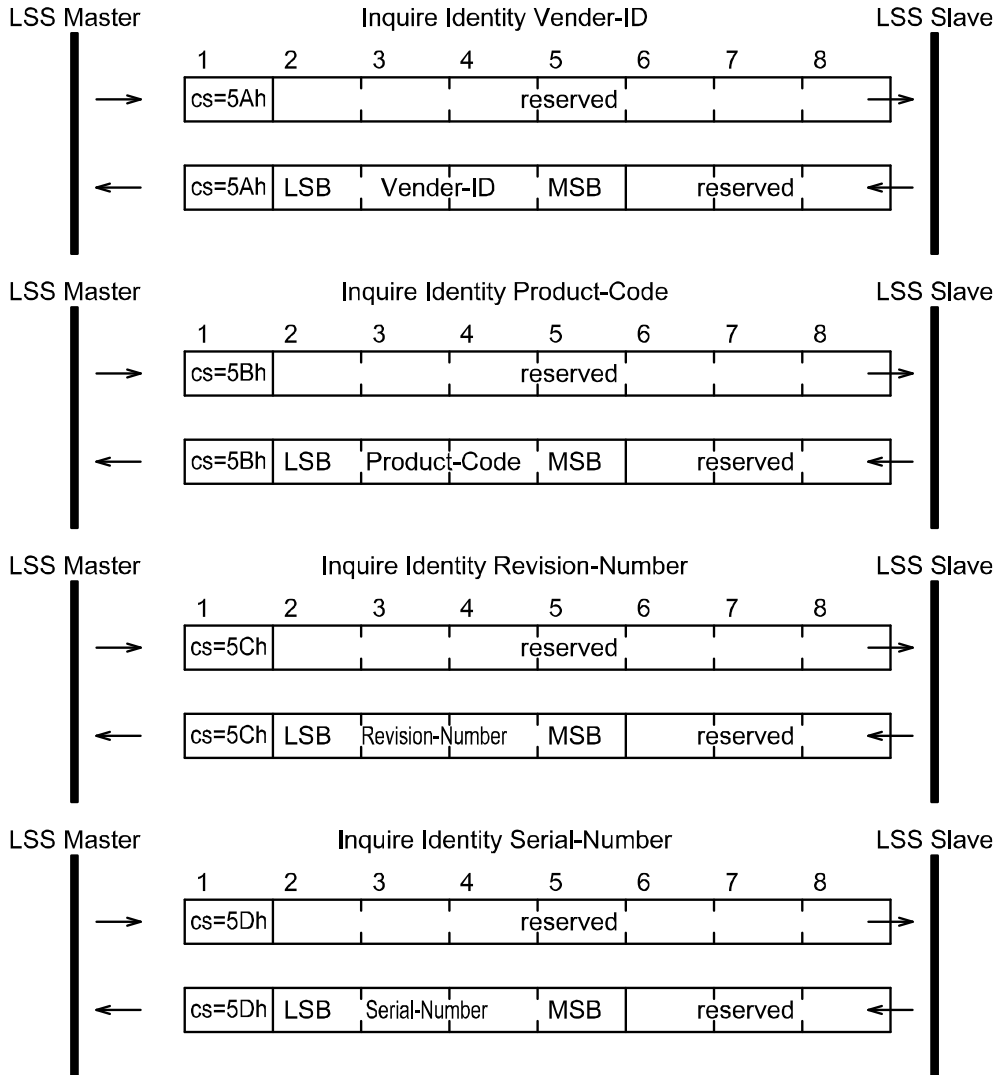

cs: LSS command specifier (5Ah for Inquire Vendor-ID)

cs: LSS command specifier (5Bh for Inquire Product-Code)

cs: LSS command specifier (5Ch for Inquire Revision-Number)

cs: LSS command specifier (5Dh for Inquire Serial-Number)

reserved: reserved for further use by CiA

•Inquire Node-ID

The service allows the determination of the Node-ID of a LSS Slave in configuration mode.

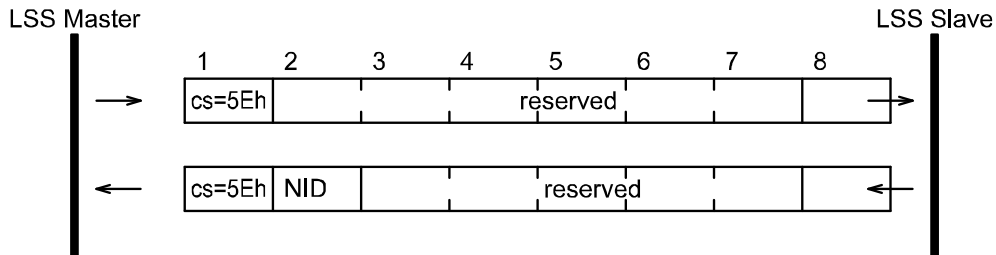

cs: LSS command specifier (5Eh for Inquire Node-ID)

NID: The Node-ID of the selected module. If the Node-ID has been changed by means of previous Configure Node-ID service, the original Node-ID is returned until the next power on reset. A value of FFh is returned if the Node-ID is not configured, which is only possible if the slave is in "LSS In it State"

reserved: reserved for further use by CiA

○Identification Services

These services are supported in configuration mode and operation mode.

•LSS Identify Remote Slaves

LSS Master can confirm the presence of LSS Slave which is specified by this service.

The LSS Slave with a corresponding address, returns "LSS Identify Slave".

Revision-Number and Serial-Number are specified within the range (Low and High).

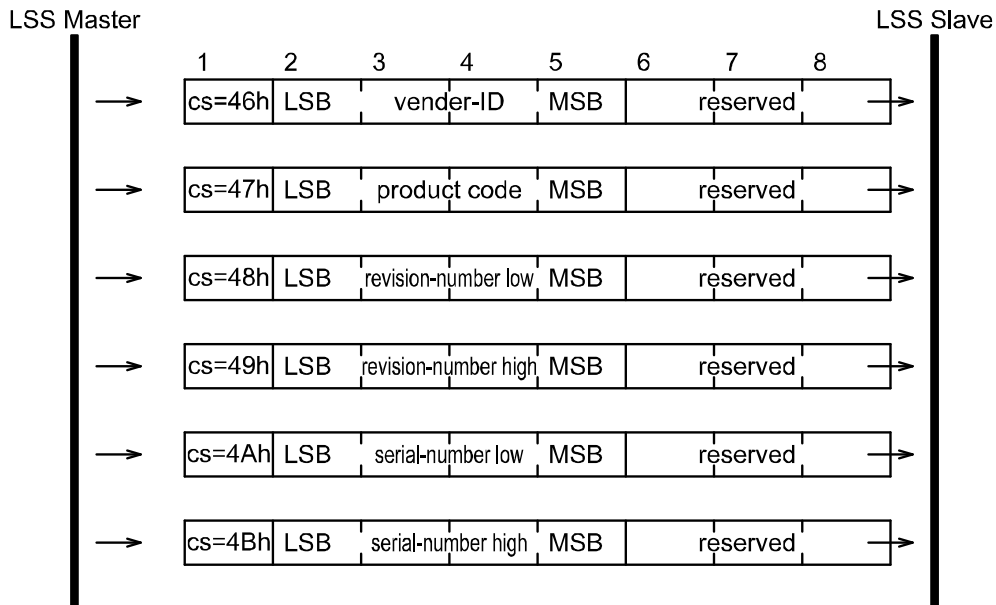

cs: LSS command specifier (46h to 4Bh for LSS Identify Remote Slaves)

reserved: reserved for further use by CiA

•LSS Identify Slave

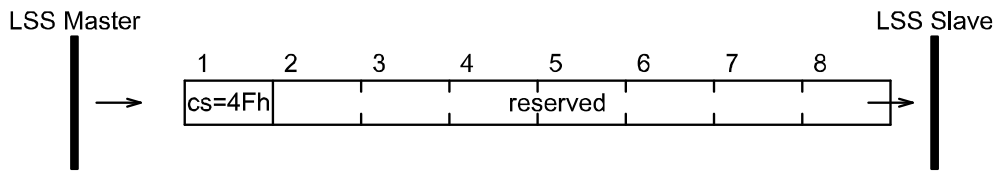

cs: LSS command specifier (4Fh for LSS Identify Slave)
 reserved: reserved for further use by CiA

•LSS Identify Non-Configured Remote Slaves

LSS Master can confirm the presence of LSS Slave which has an invalid Node-ID.
 The LSS Slave which has a corresponding address returns "LSS Identify Non-Configured Slave".

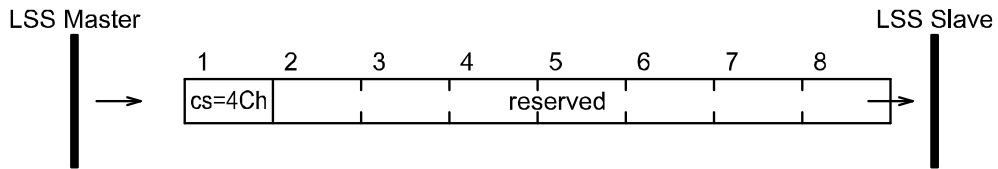

cs: LSS command specifier (4Ch for LSS Identify Non-Configured Remote Slave)
 reserved: reserved for further use by CiA

•LSS Identify Non-Configured Slave

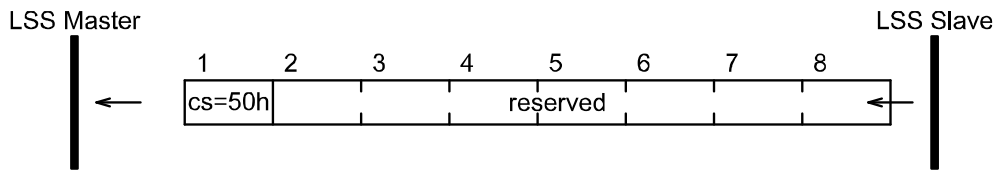

cs: LSS command specifier (50h for LSS Identify Non-Configured Slave)
 reserved: all bytes set to "0".

○Assignment of I/O No.

Correspondence between output data and valve manifold

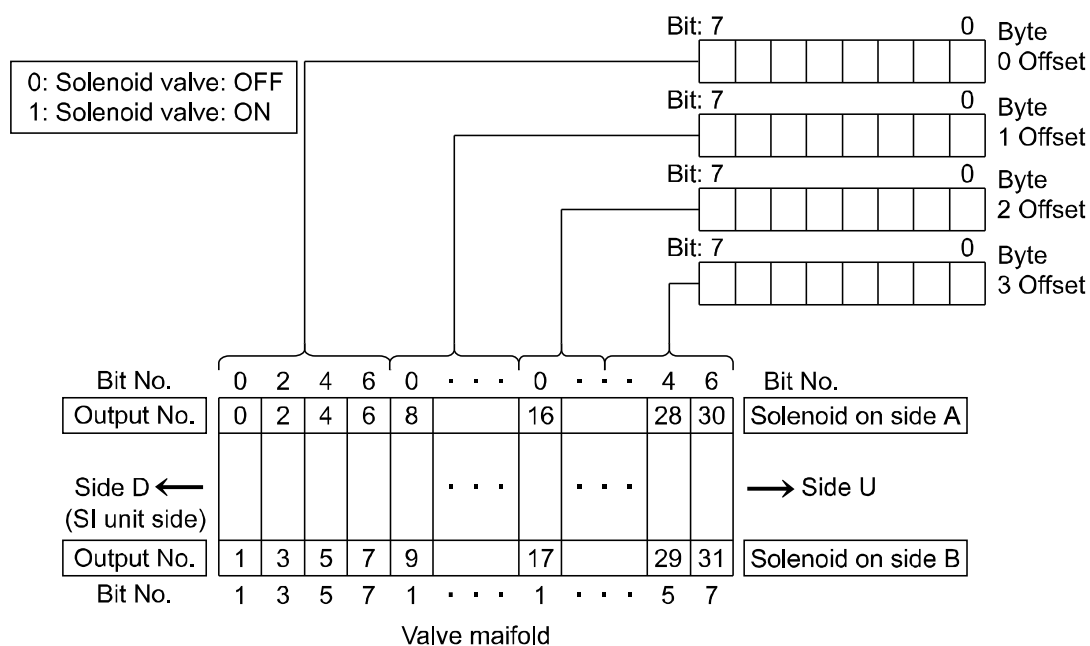

- *: Output numbers are assigned to stations from side D to U of manifold in order. (See manual of each valve manifold for the directions of side D and U)
- *: Standard manifold is wired in double. Output numbers are assigned to side A and B alternatively. In case of single solenoid valve, output on side B is free. (Refer to fig.a)
- *: Mixed (single and double) wiring is available as long as wiring specifications designate it. This allows output numbers to be specified without having free output. (Refer to fig.b)
- *: Each bit of data sent from master (4 bytes) shows ON/OFF (0: OFF, 1: ON) of solenoid valve. Starting from LSB of the first byte (Offset0), output numbers are assigned to all the bits in numeric order.

fig.a

	Double	Single	Double	Double	
No.	0	2	4	6	Side A
Station	1	2	3	4	-----
No.	1	3	5	7	Side B

fig.b

	Double	Single	Double	Double	
No.	0	2	3	5	Side A
Station	1	2	3	4	-----
No.	1	-	4	6	Side B

Open

○Correspondence between input data and input block.

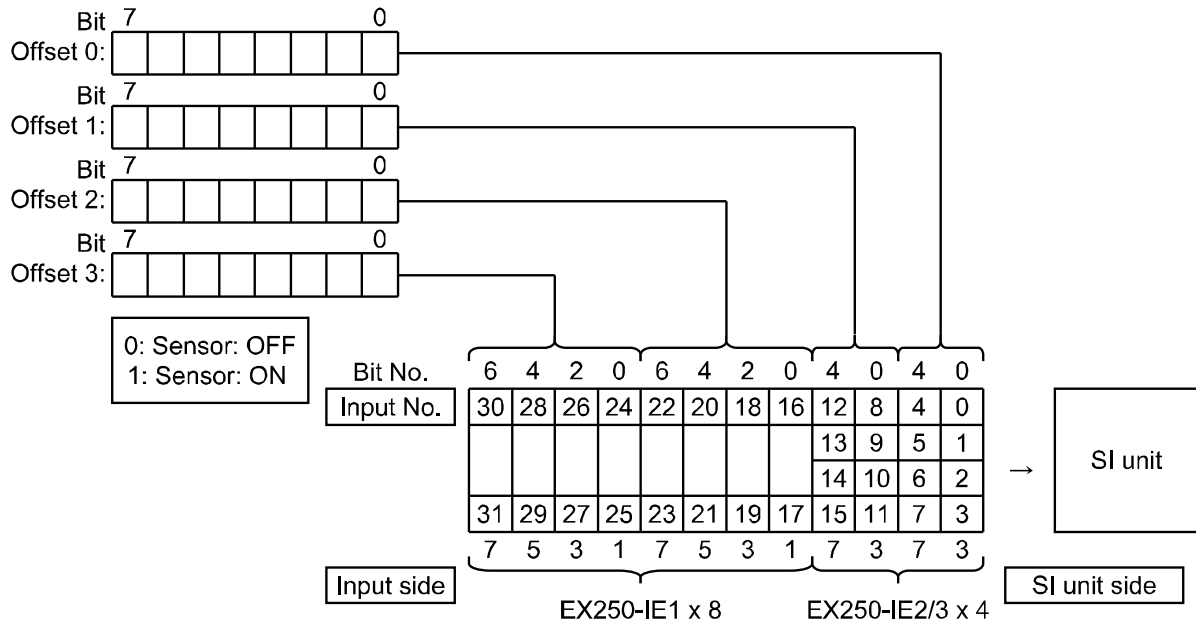

- *: Input numbers are assigned to stations from SI unit side to input side in order.
- *: Each bit of data read into master 4bytes shows ON/OFF of sensor connected to input block.
Starting from LSB of first byte (Offset 0), input numbers are assigned to all bits in numeric order.

○Example Configuration:

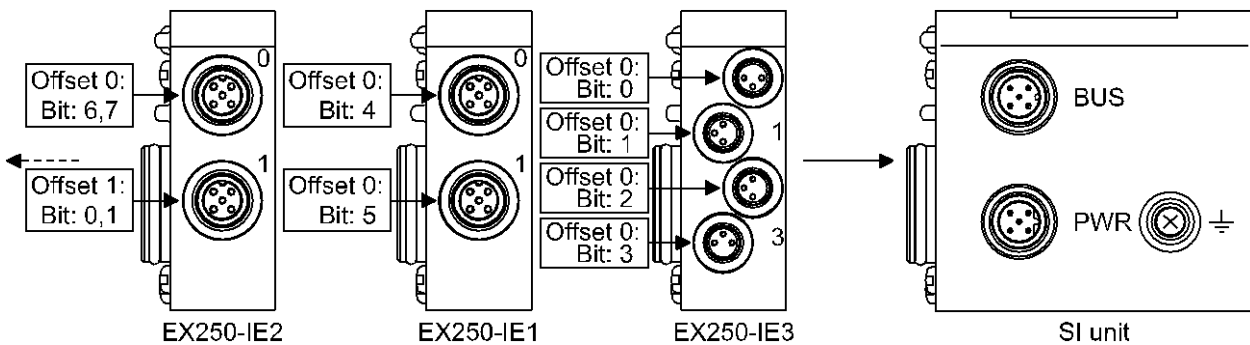

Specification of Input Blocks: (Please refer to Operation Manual EX##-OME0004)

- For EX250-IE1(M12,2 Inputs), two bits are used for input.
- For EX250-IE2/3(M12/8, 4 inputs), four bits are used for input.

Specification

■ Specifications

General specification

Item	Specification
Operating ambient temp.	-10 to +50 °C
Operating ambient humidity	35 to 85% RH (No dew condensation)
Storage ambient temp.	-20 to +60 °C
Withstand voltage	500 VAC for 1 min.
Insulation resistance	500 VDC min 10 MΩ
Operating environment	No corrosive gas
Pollution degree	Pollution degree 3
Enclosure	IP67
Standard	CE/UKCA marked, UL(CSA)
weight	250 g or less (Including accessory)

Electrical specification

Item	Specification
Power Voltage range, current consumption	Power for SI unit current consumption 18 to 30 VDC (24 VDC typical) Max. 100 mA or less
	Power for input block current consumption 24 VDC ±20% Max 1.0 A or less Depending on the number of Input Block stations and sensor specifications.
	Power for solenoid valve Current consumption 24 VDC +10%/-5% Max 2.0 A or less Depending on number of solenoid valve station and specifications.
Solenoid valve connection spec.	Output type Source/PNP (Negative common)
	Connection load Solenoid valve with protection circuit for 24 VDC and 1.5 W or less surge voltage. (made by SMC)
	Insulation type Photo coupler type
	Residual Voltage 0.3 VDC or less

Communication specification

Item	Specification
Applicable system	CAN open CiA 301 V4.02 and CiA DS-401
Node-ID setting range	1 to 63 (1 to 127 at the SW mode)
Baud rate setting range (Transmission speed)	1000 kbps, 800 kbps, 500 kbps, 250 kbps, 125 kbps, 50 kbps, 20 kbps
COB-Identifier	11 bit ID (CAN2.0 A)
Input /Output	32 points/32 points

Applicable solenoid valves

Representative series	Applicable series
VQC series	VQC1000, VQC2000, VQC4000
SV series	SV1000, SV2000, SV3000 (Tie-rod base manifold)
S0700 series	S0700
SY series	SY3000, SY5000

■Dimensions

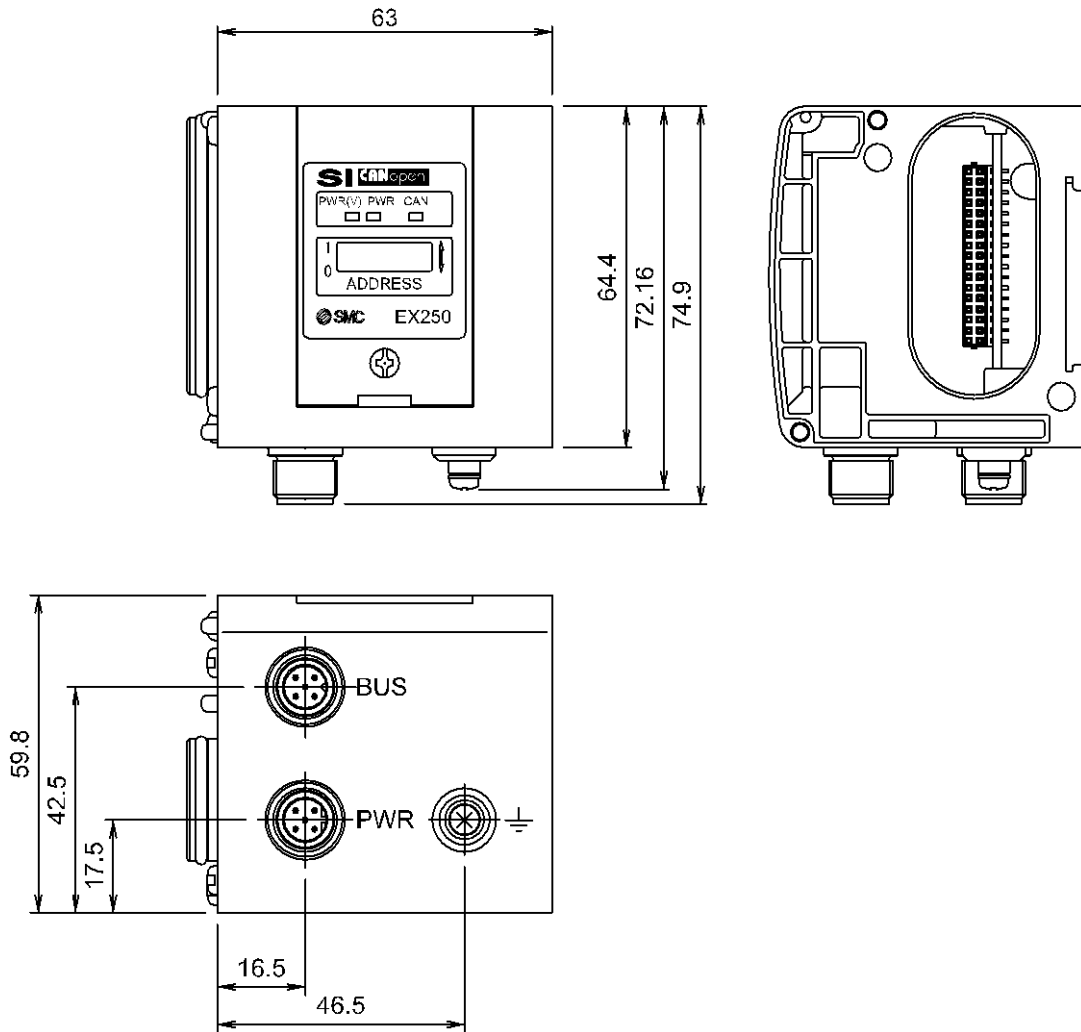

Revision history

A: All revised contents.
B: Revision.
C: Contents are added.
D: Content change. [May 2023]

SMC Corporation

4-14-1, Sotokanda, Chiyoda-ku, Tokyo 101-0021 JAPAN

Tel: + 81 3 5207 8249 Fax: +81 3 5298 5362

URL <https://www.smcworld.com>

Note: Specifications are subject to change without prior notice and any obligation on the part of the manufacturer.
© 2011-2023 SMC Corporation All Rights Reserved

