

High Purity Chemical Liquid Valve Non-Metallic Exterior

LVQ Series

Clean Wet Series

Screwless construction

Non-metallic construction without using metal screws to fasten the body of the actuator.

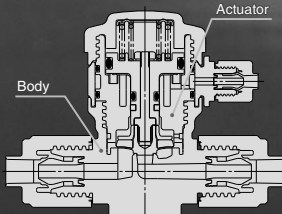

Body: **New PFA**
 Diaphragm: **PTFE**
 Actuator: **PVDF**

Additional Variations for the LVQ Series!

- Insert bushing, LQ1 integrated fitting type
Hyper fitting
LVQ-V Series

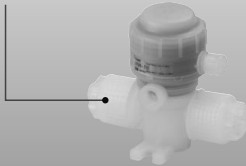

- Flare, LQ3 integrated fitting type
Hyper fitting
LVQ-Z Series

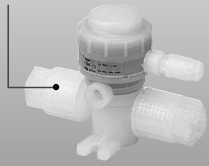

- Manually operated
LVQH Series

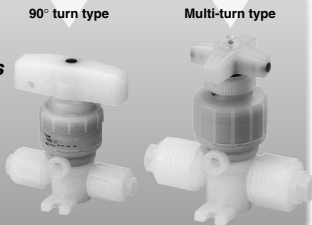

- Tube extension type
LVQ-T Series



- High purity chemical liquid valves, High back pressure (0.5 MPa) tolerant Added the **LVQ□□H** series.
- Additional options
High temperature (Max. 170°C), Buffer material FFKM, Ammonium hydroxide compatible, High flow type

LVC
LVA
LVH
LVD
LVQ
LVP
LVW
LQ1
LQ3
LVN
LQHB
TL
TIL
TLM
TILM
TD
TID
TH
TIH

● **Insert bushing/Flare, integrated fitting types are available.**

Insert bushing, Integrated fitting type *LVQ-V/LVQ-S Series*

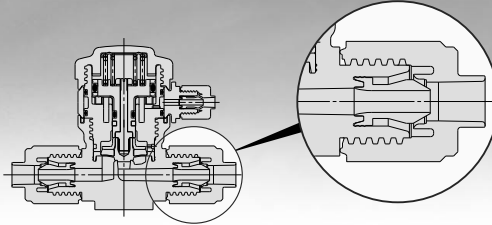

Hyper fitting

New

LQ1 Series
(LVQ-V Series)

LQ2 Series
(LVQ-S Series)

- Insert bushing type
- Quadruple seal construction

Flare, Integrated fitting type *LVQ-Z Series*

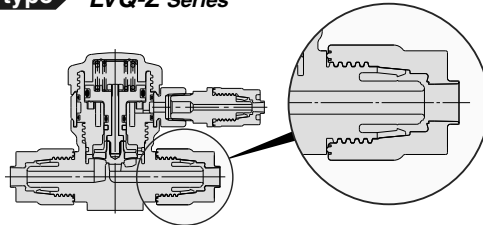

Hyper fitting
Flare type

LQ3 Series

- Grip seal construction with Flare type
- Triple seal construction

● **Added manual type.**
Two types of handle operation methods can be selected.

90° turn type



- Enables quick valve open/close switching operation.

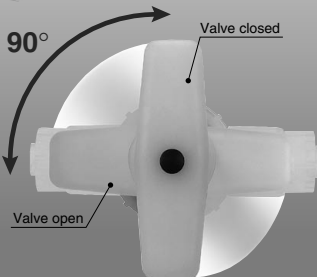

Multi-turn type



- The handle will spin loosely at the fully-open and fully-closed positions of the valve. This prevents overtightening.
- An indicator enables easy visual check of the open/closed state of the valve.
- The valve opening position can be freely set using a lock nut.

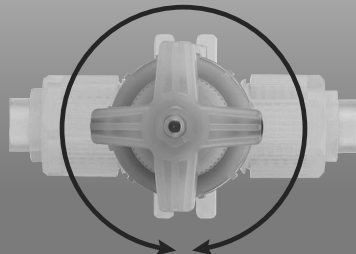

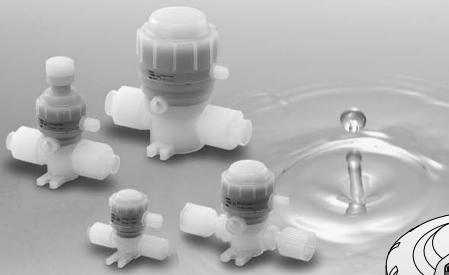

Diaphragm (PTFE)

Special diaphragm construction ensures gentle opening and closing that prevents the formation of micro-bubbles.

Minimal residual liquid

Residual liquid is minimized by the tapered shape and integrated fitting construction, allowing liquid to flow smoothly, achieving improved flow-through characteristics.

Body (New PFA)

Compatible with chemicals such as acids, bases and super pure water.

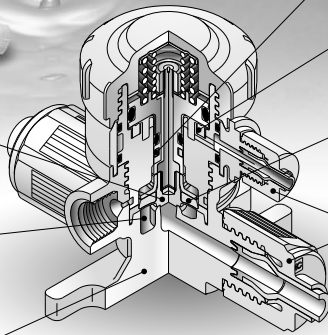

Guide ring

Eliminates lateral motion of the poppet which reduces internal leakage.

Piston damper

Absorbs piston momentum to minimize impact-induced particle generation.

Buffer

Protects diaphragm from deformation and damage due to back pressure.

Integrated fitting construction

Offers quadruple seal construction. Nut lock mechanism—no additional tightening required. High flexural strength. Different tubing sizes can be selected.

Integrated fitting construction

Hyper fitting/LQ1, LQ2, LQ3 series is used.



Integrated fitting construction

Hyper fitting/LQ1, LQ3 series is used. Can select female thread.

Piping from 8 directions are possible.

Pilot port

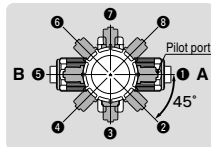

* Specify the piping direction by part number when ordering the product. Do not change the pilot port direction. (Refer to Precautions on page 846.)

Space saving type

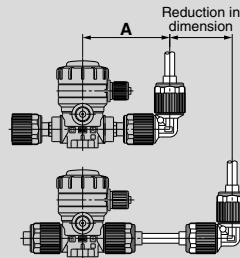

(mm)

Model	A	Reduction in dimension
LVQ20	56.5	40.5 or more
LVQ30	70	49.5 or more
LVQ40	80	61.5 or more
LVQ50	104.5	64.5 or more
LVQ60	114.5	73.5 or more

Piping example

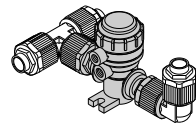

Options

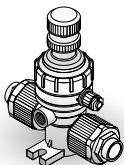

With flow rate adjustment

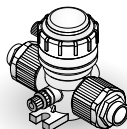

With by-pass

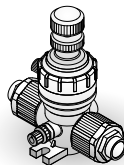

With flow rate adjustment & by-pass

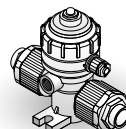

With indicator

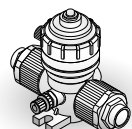

With indicator & by-pass

- LVC
- LVA
- LVH
- LVQ
- LVP
- LVW
- LQ1
- LQ3
- LVN
- LQHB
- TL
- TIL
- TLM
- TILM
- TD
- TID
- TH
- TIH

Variations

Insert Bushing, Integrated Fitting Type *LVQ/LVQH Series*



Orifice diameter	Flow rate characteristics Kv (Cv)	Series	Applicable tubing O.D.																			
			Metric size						Inch size													
			3	4	6	8	10	12	19	25	1/8	3/16	1/4	3/8	1/2	3/4	1					
ø4	0.3 (0.35)	LVQ(H)20	●	●	○								●	●	○							
ø8	1.1 (1.3)	LVQ(H)30			●	●		○							●	○						
ø10	1.6 (1.9)	LVQ(H)40						●	○							●	○					
ø16	4.2 (5)	LVQ(H)50								●	○						●	○				
ø22	6.8 (8)	LVQ(H)60										●	○					●	○			

● With reducer ○ Basic size

Insert Bushing, Integrated Fitting Type Space Saving/Space Saving Connection *LVQS/LVQHS Series*



Orifice diameter	Flow rate characteristics Kv (Cv)	Series	Fitting size					
			2	3	4	5	6	
ø4	0.3 (0.35)	LVQ(H)S20	●					
ø8	1.1 (1.3)	LVQ(H)S30		●				
ø10	1.6 (1.9)	LVQ(H)S40			●			
ø16	4.2 (5)	LVQ(H)S50				●		
ø22	6.8 (8)	LVQ(H)S60					●	

Flare, Integrated Fitting Type *LVQ-Z/LVQH-Z Series*



Orifice diameter	Flow rate characteristics Kv (Cv)	Series	Applicable tubing O.D.																			
			Metric size						Inch size													
			3	4	6	8	10	12	19	25	1/8	3/16	1/4	3/8	1/2	3/4	1					
ø4	0.3 (0.35)	LVQ20(H)-Z	●	●	●																	
ø8	1.1 (1.3)	LVQ30(H)-Z						●														
ø10	1.6 (1.9)	LVQ40(H)-Z							●													
ø16	4.2 (5)	LVQ50(H)-Z								●												
ø22	6.8 (8)	LVQ60(H)-Z									●											

Flare, Integrated Fitting Type Space Saving/Space Saving Connection *LVQS-Z/LVQHS-Z Series*



Orifice diameter	Flow rate characteristics Kv (Cv)	Series	Fitting size					
			2	3	4	5	6	
ø4	0.3 (0.35)	LVQ20(H)S-Z	●					
ø8	1.1 (1.3)	LVQ30(H)S-Z		●				
ø10	1.6 (1.9)	LVQ40(H)S-Z			●			
ø16	4.2 (5)	LVQ50(H)S-Z				●		
ø22	6.8 (8)	LVQ60(H)S-Z					●	

Tube Extension Type *LVQ-T/LVQH-T Series*

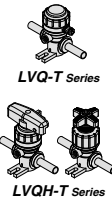

Orifice diameter	Flow rate characteristics Kv (Cv)	Series	Tubing size																		
			Metric size				Inch size														
			6	10	12	19	25	1/4	3/8	1/2	3/4	1									
ø4	0.3 (0.35)	LVQ20(H)-T	●																		
ø8	1.1 (1.3)	LVQ30(H)-T		●																	
ø10	1.6 (1.9)	LVQ40(H)-T			●																
ø16	4.2 (5)	LVQ50(H)-T				●															
ø22	6.8 (8)	LVQ60(H)-T					●														

Guide to Pamphlet on Fluoropolymer Fitting Installation Methods

* The pamphlets can be downloaded from the SMC home page. <http://www.smcworld.com>

LQ1/2 Series Installation Method

R type

For fitting sizes 1 to 6

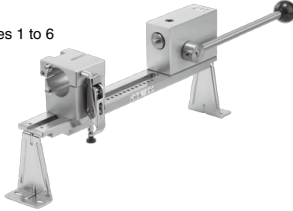

J type

For fitting sizes 1 and 2



K type

For fitting sizes 1 and 2

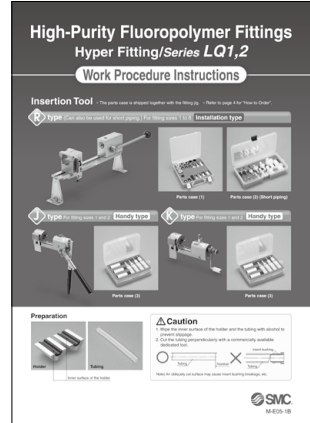

M-E05-1

LQ3 Series Installation Method

For fitting sizes 2 to 6



For fitting size 1

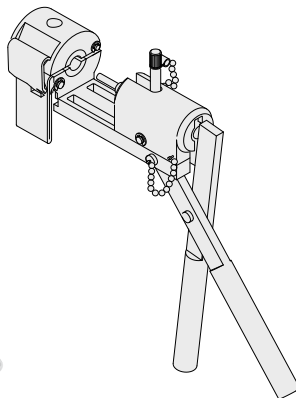

M-E06-4

LVC
LVA
LVB
LVD
LVQ
LVP
LVV
LQ1
LQ3
LVN
LQHB
TL
TIL
TLM
TILM
TD
TID
TH
TIH

INDEX

Insert Bushing, Integrated Fitting Type

**Air Operated
Insert Bushing, Integrated Fitting Type
Hyper Fitting**

● **LVQ Series**

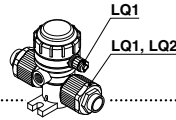

P.778

**Air Operated
Insert Bushing, Integrated Fitting Type
Space Saving/Space Saving Connection**

● **LVQS Series**

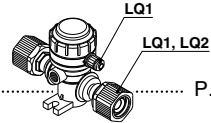

P.786

**Manually Operated
Insert Bushing, Integrated Fitting Type
Hyper Fitting**

● **LVQH Series**

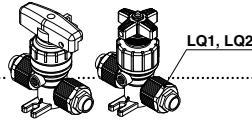

P.795

**Manually Operated
Insert Bushing, Integrated Fitting Type
Space Saving/Space Saving Connection**

● **LVQHS Series**

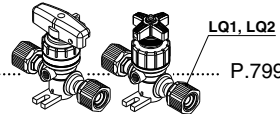

P.799

Fittings and Special Tools

P.804

Flare, Integrated Fitting Type

**Air Operated
Flare, Integrated Fitting Type
Hyper Fitting**

● **LVQ-Z Series**

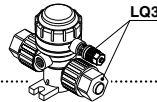

P.805

**Air Operated
Flare, Integrated Fitting Type
Space Saving/Space Saving Connection**

● **LVQS-Z Series**

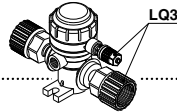

P.813

**Manually Operated
Flare, Integrated Fitting Type
Hyper Fitting**

● **LVQH-Z Series**

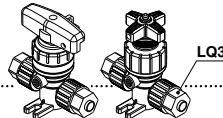

P.822

**Manually Operated
Flare, Integrated Fitting Type
Space Saving/Space Saving Connection**

● **LVQHS-Z Series**

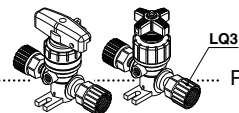

P.826

INDEX

Tube Extension Type

Air Operated
Tube Extension Type
● **LVQ-T Series**

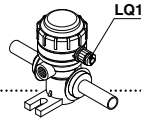

P.831

Manually Operated
Tube Extension Type
● **LVQH-T Series**

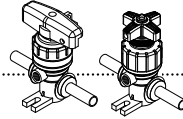

P.838

Insert Bushing,
Integrated
Fitting Type

Air Operated, 0.5 MPa Back Pressure Tolerant
Insert Bushing, Integrated Fitting Type
Hyper Fitting
● **LVQ□□H Series**

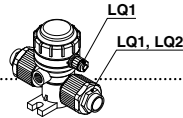

P.841

Flare,
Integrated
Fitting Type

Air Operated, 0.5 MPa Back Pressure Tolerant
Flare, Integrated Fitting Type
Hyper Fitting
● **LVQ□□H-Z Series**

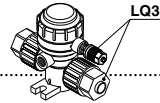

P.842

Applicable Fluids

P.844

Specific Product Precautions

P.845, 846

LVC

LVA

LVH

LV D

LVQ

LVP

LVW

LQ1

LQ3

LVN

LQHB

TL

TIL

TLM

TILM

TD

TID

TH

TIH

Air Operated Insert Bushing, Integrated Fitting Type Hyper Fitting **LVQ Series**

RoHS

How to Order

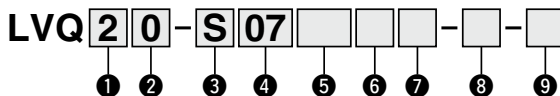

① Body class

Symbol	Body class	Orifice dia.
2	2	ø4
3	3	ø8
4	4	ø10
5	5	ø16
6	6	ø22

② Valve type

0	N.C.
1	N.O.
2	Double acting

Note) For valve type combinations, refer to variations on the next page.

③ Fitting type

Symbol	Fitting type	Body class
V	LQ1	2, 3, 4, 5, 6
S	LQ2	2, 3, 4, 5

Note) Insert bushing is used in common.

④ Applicable tubing size^{Note)}

Symbol	Connection tubing size	Body class				
		2	3	4	5	6
Metric size						
03	3 x 2	●				
04	4 x 3	●				
06	6 x 4	○	●			
08	8 x 6		●			
10	10 x 8		○	●		
12	12 x 10			○	●	
19	19 x 16				○	●
25	25 x 22					○
Inch size						
03	1/8" x 0.086"	●				
05	3/16" x 1/8"	●				
07	1/4" x 5/32"	○	●			
11	3/8" x 1/4"		○	●		
13	1/2" x 3/8"			○	●	
19	3/4" x 5/8"				○	●
25	1" x 7/8"					○

○ Basic size ● With reducer

Note) Refer to page 846 for details of the applicable tubing sizes.

⑤ Port B (OUT) different dia. size

Symbol	Application
Nii	Ports A & B same size
Refer to the applicable tubing size table to the left.	Different diameter tubings can be selected within the same body class.

⑥ Pilot port type

Nii	LQ1 integrated fitting	Connection tubing size 1/8" x 0.086" (3 x 2) ^{Note)}
M	LQ1 integrated fitting	Connection tubing size 4 x 3 ^{Note)}
R	Threaded	Rc1/8
N	Threaded	NPT1/8

Note) Refer to page 846 for details of the applicable tubing sizes.

⑦ Pilot port direction

Symbol	Direction
Nii	①
P2	②
P3	③
P4	④
P5	⑤
P6	⑥
P7	⑦
P8	⑧

Pilot port piping direction

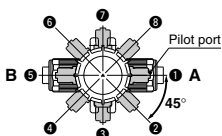

* Specify the piping direction by part number when ordering the product. Do not change the pilot port direction. (Refer to Precautions on page 846.)

8 Option 1

NII	None
1	With flow rate adjustment
2	With by-pass
3	With flow rate adjustment & by-pass
4	With indicator
5	High back pressure (0.42 MPa)
6	High back pressure with flow rate adjustment
7	High back pressure with by-pass
8	High back pressure with flow rate adjustment & by-pass
9	High back pressure with indicator
24	With indicator & by-pass











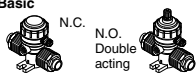
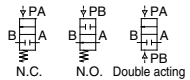

Note) Refer to variations in the table below for valve type and option 1 combinations. Options in the same table can not be combined each other.

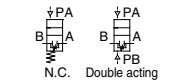
9 Option 2

Symbol	Applicable option										Note
	1	2	3	4	5	6	7	8	9	24	
NII	○	○	○	○	○	○	○	○	○	○	—
J	○	—	—	—	—	—	—	—	—	—	For high temperature
K	○	○	○	○	○	○	○	○	○	○	Buffer material FFKM
N	○	○	○	○	○	○	○	○	○	○	For ammonium hydroxide
P	—	—	—	○	○	—	—	—	—	—	High flow type LVQ6□ only

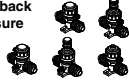
Note 1) Options 2 in the same table cannot be combined each other.
Note 2) High back pressure specifications (5 to 9) in Option 1 and high temperature specification (J) in Option 2 cannot be combined.

Variations

Type	Symbol	Valve type	Model						
			Orifice diameter		LVQ20	LVQ30	LVQ40	LVQ50	LVQ60
			Tubing O.D.		Metric	Inch			
Basic 		N.C. N.O. Double acting Double acting	Orifice diameter ø4	ø8	ø10	ø16	ø22		
			Metric 6	10	12	19	25		
			Inch 1/4	3/8	1/2	3/4	1		
With flow rate adjustment 		N.C.	○	○	○	○	○		
With by-pass 		N.C. Double acting	○	○	○	○	○		
With flow rate adjustment & by-pass 		N.C.	○	○	○	○	○		
With indicator 		N.C.	○	○	○	○	○		
High back pressure 		N.C.	○	○	○	○	○		
With indicator & by-pass 		N.C.	○	○	○	○	○		

- LVC
- LVA
- LVH
- LVD
- LVQ**
- LVP
- LVW
- LQ1
- LQ3
- LVN
- LQHB
- TL
- TIL
- TLM
- TID
- TIH

Standard Specifications



Model		LVQ20	LVQ30	LVQ40	LVQ50	LVQ60
Tubing O.D. ^(Note 1)	Metric	6	10	12	19	25
	Inch	1/4	3/8	1/2	3/4	1
Fitting type	IN/OUT port	LQ1 or LQ2				LQ1
	Pilot port	LQ1				
Orifice diameter		ø4	ø8	ø10	ø16	ø22
Flow rate characteristics	Kv	0.3	1.1	1.6	4.2	6.8 (8.1) ^(Note 2)
	Cv	0.35	1.3	1.9	5	8 (9.5) ^(Note 2)
Withstand pressure (MPa)		1				
Operating pressure <A→B flow>	Standard	-98 kPa to 0.5 MPa ^(Note 3)			-98 kPa to 0.4 MPa ^(Note 3)	
	High temperature	-98 kPa to 0.3 MPa ^(Note 3)				
Back pressure (MPa)	Standard	0.3 or less		0.2 or less		
	High back pressure	0.42 or less				
	High temperature	0.3 or less		0.2 or less		
Valve leakage (cm ³ /min)		0 (With water pressure)				
Pilot air pressure (MPa)		0.3 to 0.5 (High back pressure: 0.45 to 0.55)				
Pilot port size		1/8" (ø3), ø4, Rc 1/8, NPT 1/8				
Fluid temperature (°C)	Standard	0 to 100				
	High temperature	0 to 170				
Ambient temperature (°C)		0 to 60				
Weight (kg)		0.08	0.17	0.22	0.70	0.81

Note 1) Refer to page 846 for details of the applicable tubing sizes.

Note 2) (): High flow type

Note 3) This product cannot be used for vacuum retention. Also, connecting the vacuum to the B port may reduce the life of the product.

⚠ Specific Product Precautions

Be sure to read this before handling the products. Refer to back page 50 for Safety Instructions and pages 845 and 846 for Air Operated Chemical Liquid Valve Precautions.

Piping

⚠ Caution

1. Connect tubing by special tools.

For information on tubing connection and special tools, please see the pamphlet "High Purity Fluoropolymer Fittings Hyper Fitting LQ1/2 Series Work Procedure Instructions" (M-E05-1). (The pamphlet can be downloaded from the SMC home page.)

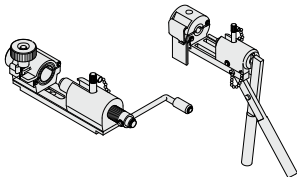

2. Tighten the nut until it touches the end surface of the body, and then tighten it an additional 1/8 turn. If the nut won't turn any further, then it means a sufficient tightening has occurred. Refer to the proper tightening torques shown below.

Tightening Torque for Piping

Body class	Torque (N·m)	
	LQ1	LQ2
2	0.3 to 0.4	1.5 to 2.0
3	0.8 to 1.0	3.0 to 3.5
4	1.0 to 1.2	7.5 to 9.0
5	2.5 to 3.0	11.0 to 13.0
6	5.5 to 6.0	—

Applicable Different Diameter Tubings with Reducer

Different diameter tubings can be selected (within the same body class) by using a nut and an insert bushing (reducer). ● With reducer

Body class	Connection tubing O.D.														
	Metric size						Inch size								
	3	4	6	8	10	12	19	25	1/8	3/16	1/4	3/8	1/2	3/4	1
2	●	●	○	—	—	—	—	—	●	●	○	—	—	—	—
3	—	—	●	●	○	—	—	—	—	●	○	—	—	—	—
4	—	—	—	—	●	○	—	—	—	—	—	●	○	—	—
5	—	—	—	—	—	—	○	○	—	—	—	—	●	○	—
6	—	—	—	—	—	—	—	●	○	—	—	—	—	●	○

Note) Refer to page 804 for information on changing tubing sizes.

LVQ

LVA

LVH

LVJ

LVK

LVP

LVW

LQ1

LQ3

LVN

LQHB

TL TIL

TLM TILM

TD TID

TH TIH

LVQ Series

Construction

Basic

N.C.

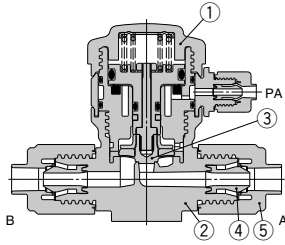

N.O.

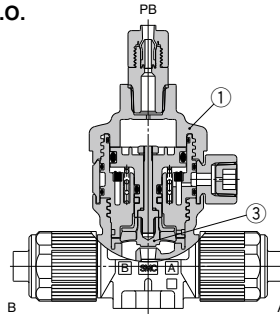

Double acting

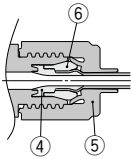
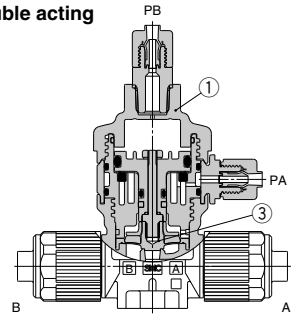

With reducer

With flow rate adjustment

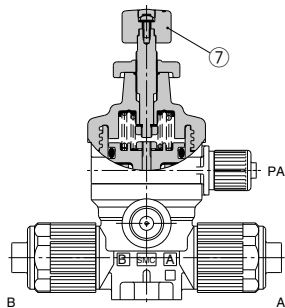

With by-pass

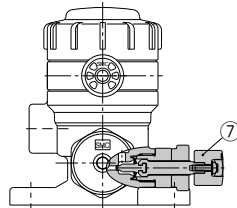

With indicator

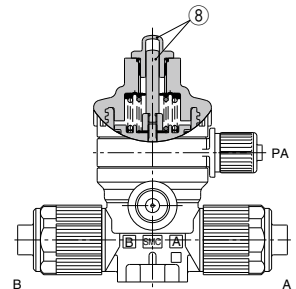

Component Parts

No.	Description	Material
1	Actuator	PVDF
2	Body	PFA
3	Diaphragm	PTFE
4	Insert bushing	PFA
5	Nut	PFA
6	Collar	PFA
7	Flow rate adjuster	PVDF
8	Indicator/Cover	PP

Dimensions

Basic, High back pressure

N.C. valve

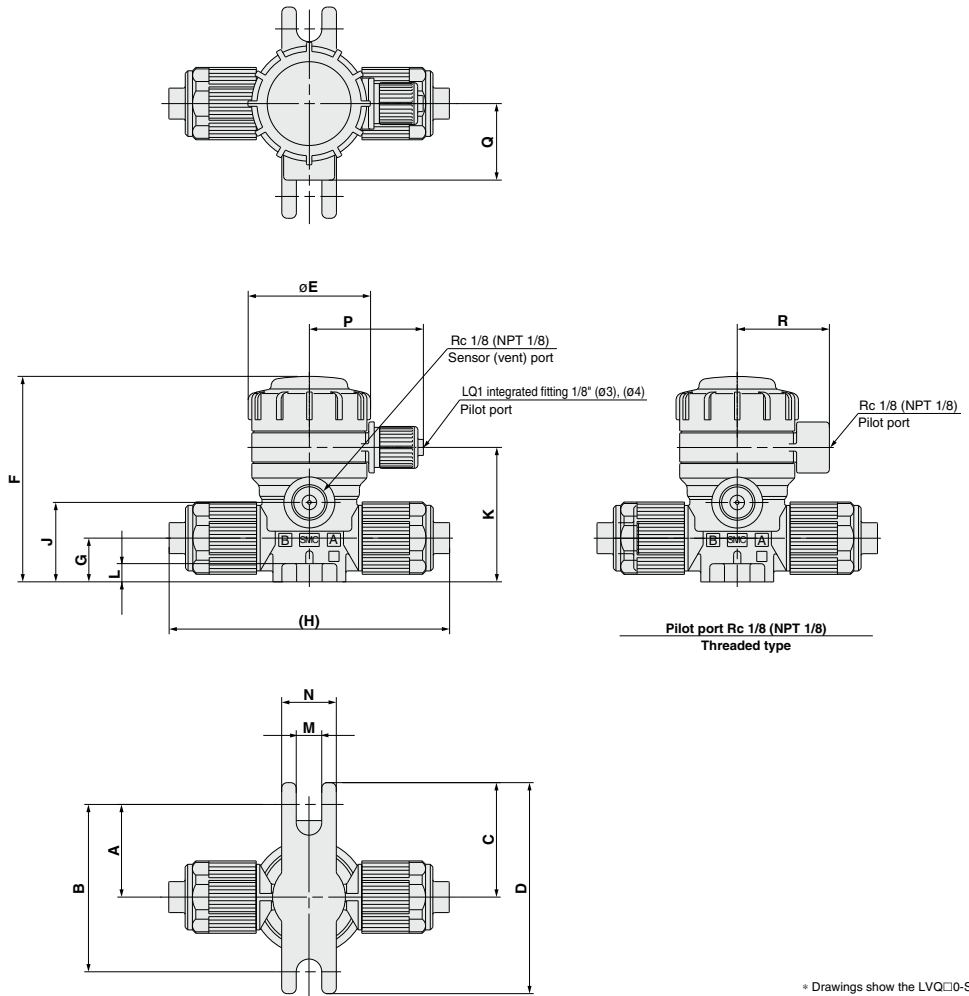

* Drawings show the LVQ□0-S.

LVQ□0- $\frac{V}{S}$ □ Dimensions (N.C. Valve)

(mm)

Model	A	B	C	D	E	F	G	H		J	K	L	M	N	P	Q	R
								V□	S□								
LVQ20- $\frac{V}{S}$ □	25.5	46	31.5	58	33.6	56.5	12	70	77	21.8	37	5	7	15	31.3	21	25.3
LVQ30- $\frac{V}{S}$ □	28.5	57	34.5	69	45.4	77	16.5	83	95	32	50	6	7	20	37.2	25	31.2
LVQ40- $\frac{V}{S}$ □	28.5	57	34.5	69	45.4	82.5	22	95	109	37.5	55.5	6	7	20	37.2	25	31.2
LVQ50- $\frac{V}{S}$ □	42	84	48	96	75	127	25	130	141	50.2	78.2	10	7	20	50.8	38.5	45
LVQ60-V□*	42	84	48	96	75	136.8	32	150	—	60	88	10	7	20	50.8	38.5	45

* The LVQ60 is available only with "V".

LVC
LVA
LVH
LVD
LVQ
LVP
LVW
LQ1
LQ3
LVN
LQHB
TL
TIL
TLM
TILM
TD
TID
TH
TIH

LVQ Series

Dimensions

With flow rate adjustment, High back pressure with flow rate adjustment

N.C. valve

Dimensions (mm)	
Model	S
LVQ20- $\frac{1}{2}$ □-1	83
LVQ30- $\frac{1}{2}$ □-1	113.5
LVQ40- $\frac{1}{2}$ □-1	119
LVQ50- $\frac{1}{2}$ □-1	171.5
LVQ60-V□-1*	182.5

* The LVQ60 is available only with "V".

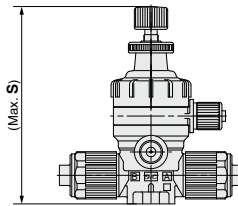

With by-pass, High back pressure with by-pass

N.C. valve

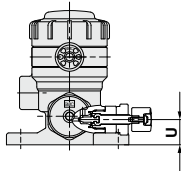
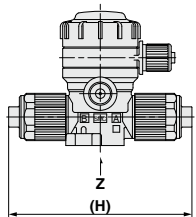
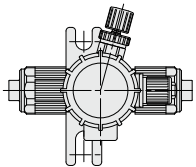

LVQ20

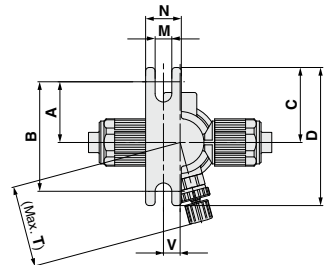

LVQ30, LVQ40
LVQ50, LVQ60

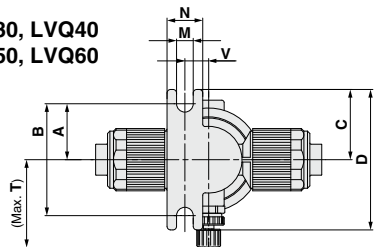

View Z

* Drawings show the LVQ□0-S.

Dimensions

Model	Dimensions (mm)										
	A	B	C	D	M	N	T	U	V	H	
										V□	S□
LVQ20- $\frac{1}{2}$ □-2	25.5	46	31.5	58	7	15	34.3	10.6	7	64	77
LVQ30- $\frac{1}{2}$ □-2	25.5	51	31.5	63	7	15	36.9	16.5	10	83	95
LVQ40- $\frac{1}{2}$ □-2	25.5	51	31.5	63	7	15	37.9	22	10	95	109
LVQ50- $\frac{1}{2}$ □-2	38	76	44	88	7	20	64	25	17	130	141
LVQ60-V□-2*	38	76	44	88	7	20	66	32	17	150	—

* The LVQ60 is available only with "V".

With flow rate adjustment & by-pass,
High back pressure with flow rate adjustment & by-pass
N.C. valve

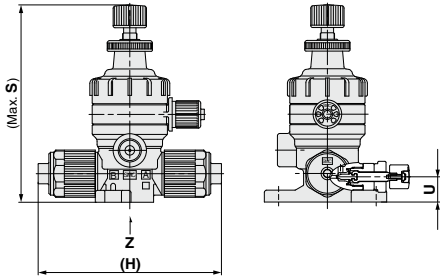
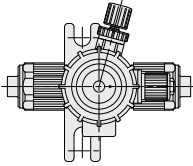

LVQ20

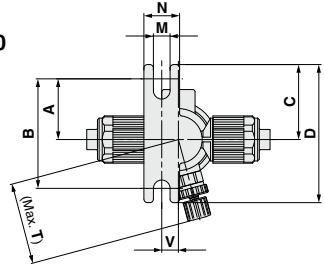

LVQ30, LVQ40
LVQ50, LVQ60

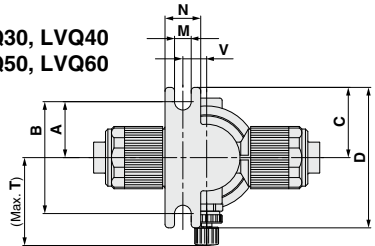

View Z

* Drawings show the LVQ□0-S.

Dimensions

(mm)

Model	A	B	C	D	M	N	S	T	U	V	H	
											V□	S□
LVQ20- $\frac{1}{2}$ □-3	25.5	46	31.5	58	7	15	83	34.3	10.6	7	64	77
LVQ30- $\frac{3}{4}$ □-3	25.5	51	31.5	63	7	15	113.5	36.9	16.5	10	83	95
LVQ40- $\frac{1}{2}$ □-3	25.5	51	31.5	63	7	15	119	37.9	22	10	95	109
LVQ50- $\frac{3}{4}$ □-3	38	76	44	88	7	20	171.5	64	25	17	130	141
LVQ60-V□-3*	38	76	44	88	7	20	182.5	66	32	17	150	—

* The LVQ60 is available only with "V".

With indicator, High back pressure with indicator
N.C. valve

Dimensions

(mm)

Model	S
LVQ20- $\frac{1}{2}$ □-4	70.5
LVQ30- $\frac{3}{4}$ □-4	88.5
LVQ40- $\frac{1}{2}$ □-4	94
LVQ50- $\frac{3}{4}$ □-4	134.5
LVQ60-V□-4*	144

* The LVQ60 is available only with "V".

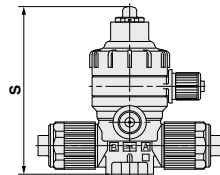

* Drawings show the LVQ□0-S.

LVQ
LVA
LVH
LVD
LVQ
LVP
LVW
LQ1
LQ3
LVN
LQHB
TL
TIL
TLM
TILM
TD
TID
TH
TIH

LVQ Series

Dimensions

Basic N.O. valve

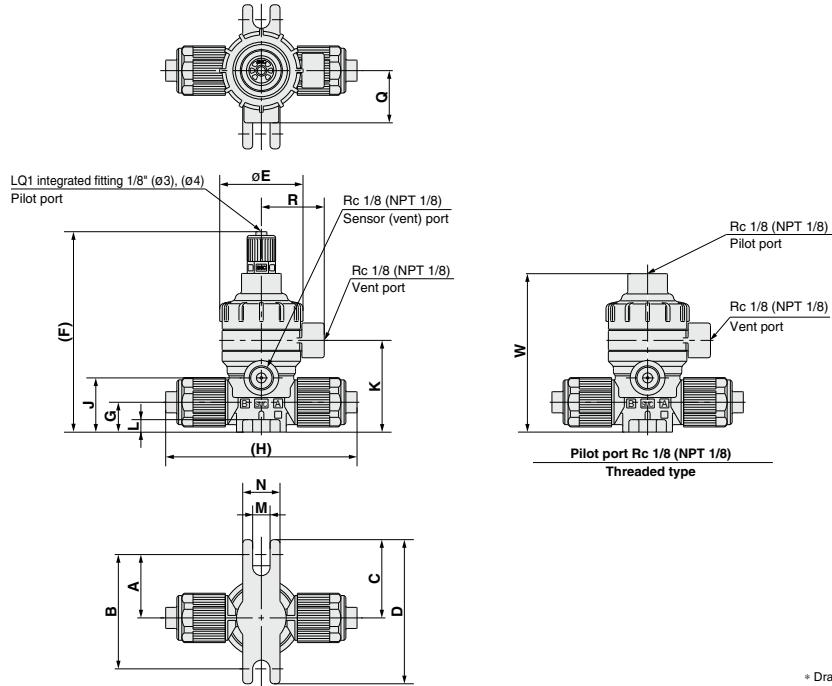

* Drawings show the LVQ□0-S.

Double acting valve

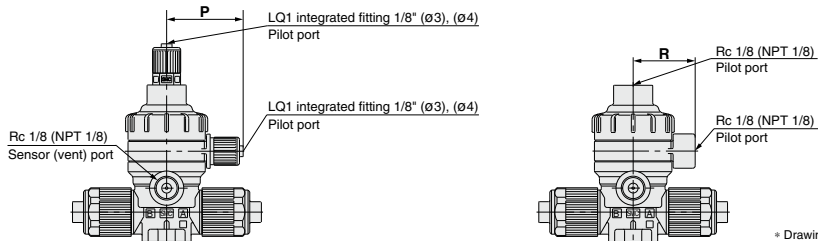

* Drawings show the LVQ□0-S.

LVQ□ $\frac{1}{2}$ - $\frac{3}{8}$ □ Dimensions (N.O. Valve, Double Acting Valve)

(mm)

Model	A	B	C	D	E	F	G	H		J	K	L	M	N	P	Q	R	W
								V□	S□									
LVQ2 $\frac{1}{2}$ - $\frac{3}{8}$ □	25.5	46	31.5	58	33.6	81	12	70	77	21.8	37	5	7	15	31.3	21	25.3	64
LVQ3 $\frac{1}{2}$ - $\frac{3}{8}$ □	28.5	57	34.5	69	45.4	99	16.5	83	95	32	50	6	7	20	37.2	25	31.2	82
LVQ4 $\frac{1}{2}$ - $\frac{3}{8}$ □	28.5	57	34.5	69	45.4	104.5	22	95	109	37.5	55.5	6	7	20	37.2	25	31.2	87.5
LVQ5 $\frac{1}{2}$ - $\frac{3}{8}$ □	42	84	48	96	75	145	25	130	141	50.2	78.2	10	7	20	50.8	38.5	45	128
LVQ6 $\frac{1}{2}$ -V□*	42	84	48	96	75	154.5	32	150	—	60	88	10	7	20	50.8	38.5	45	137.5

* The LVQ60 is available only with "V".

**With by-pass
Double acting valve**

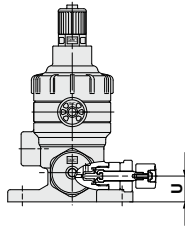
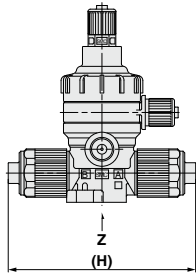
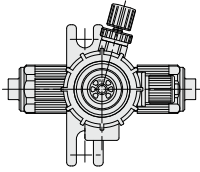

LVQ2₁²

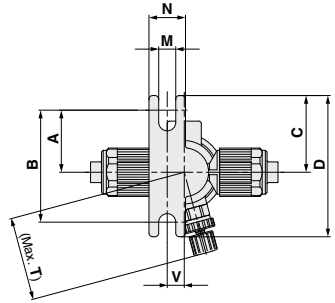

**LVQ3₁², LVQ4₁²
LVQ5₁², LVQ6₁²**

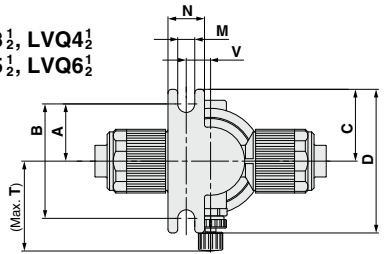

View Z

* Drawings show the LVQ□0-S.

LVC
LVA
LVH
LVD
LVQ
LVP
LVW
LQ1
LQ3
LVN
LQHB
TL
TIL
TLM
TILM
TD
TID
TH
TIH

Dimensions (N.O Valve, Double Acting Valve)

(mm)

Model	A	B	C	D	M	N	T	U	V	H	
										V□	S□
LVQ2 ₁ ² -□-2	25.5	46	31.5	58	7	15	34.3	10.6	7	64	77
LVQ3 ₁ ² -□-2	25.5	51	31.5	63	7	15	36.9	16.5	10	83	95
LVQ4 ₁ ² -□-2	25.5	51	31.5	63	7	15	37.9	22	10	95	109
LVQ5 ₁ ² -□-2	38	76	44	88	7	20	64	25	17	130	141
LVQ6 ₁ ² -V□-2*	38	76	44	88	7	20	66	32	17	150	—

* The LVQ60 is available only with "V".

Air Operated Insert Bushing, Integrated Fitting Type Space Saving/Space Saving Connection **LVQS Series**

RoHS

How to Order

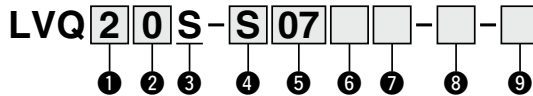

1 Body class

Symbol	Body class	Orifice dia.
2	2	ø4
3	3	ø8
4	4	ø10
5	5	ø16
6	6	ø22

2 Valve type

0	N.C.
1	N.O.
2	Double acting

Note) For valve type combinations, refer to variations on the next page.

3 Body type

S	Space saving connection
---	-------------------------

4 Fitting type

Symbol	Fitting type	Body class
V	LQ1	2, 3, 4, 5, 6
S	LQ2	2, 3, 4, 5

Note) Insert bushing is used in common.

5 Applicable fitting size

Symbol	Fitting size	Body class					
		2	3	4	5	6	
07	2	○					
11	3		○				
13	4			○			
19	5				○		
25	6					○	

Note) Refer to page 787 for How to Order fitting parts. Select a tube with the same size as the valve side fitting.

6 Pilot port type

Nil	LQ1 integrated fitting	Connection tubing size 1/8" x 0.086" (3 x 2) ^{Note)}
M	LQ1 integrated fitting	Connection tubing size 4 x 3 ^{Note)}
R	Threaded	Rc1/8
N	Threaded	NPT1/8

Note) Refer to page 846 for details of the applicable tubing sizes.

7 Pilot port direction

Symbol	Direction
Nil	1
P2	2
P3	3
P4	4
P5	5
P6	6
P7	7
P8	8

Pilot port piping direction

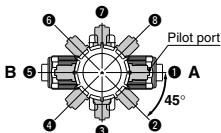

* Specify the piping direction by part number when ordering the product. Do not change the pilot port direction. (Refer to Precautions on page 846.)

8 Option 1

Nii	None
1	With flow rate adjustment
2	With by-pass
3	With flow rate adjustment & by-pass
4	With indicator
5	High back pressure (0.42 MPa)
6	High back pressure with flow rate adjustment
7	High back pressure with by-pass
8	High back pressure with flow rate adjustment & by-pass
9	High back pressure with indicator
24	With indicator & by-pass











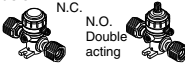
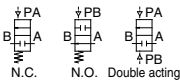

Note) Refer to variations in the table below for valve type and option 1 combinations. Options in the same table can not be combined each other.

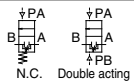
9 Option 2

Symbol	Applicable option										Note
	1	2	3	4	5	6	7	8	9	24	
Nii	○	○	○	○	○	○	○	○	○	○	—
J	○	—	—	—	—	—	—	—	—	—	For high temperature
K	○	○	○	○	○	○	○	○	○	○	Buffer material FFKM
N	○	○	○	○	○	○	○	○	○	○	For ammonium hydroxide
P	—	—	—	○	○	—	—	—	—	—	High flow type LVQ6□ only

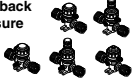
Note 1) Options 2 in the same table cannot be combined each other.
Note 2) High back pressure specifications (5 to 9) in Option 1 and high temperature specification (J) in Option 2 cannot be combined.

Variations

Type	Symbol	Model	LVQ20	LVQ30	LVQ40	LVQ50	LVQ60	
			Orifice diameter					
			Applicable fitting size					
		Valve type	ø4	ø8	ø10	ø16	ø22	
Basic  N.C. Double acting	 N.C. Double acting	N.C.	○	○	○	○	○	
		N.O.	○	○	○	○	○	
		Double acting	○	○	○	○	○	
With flow rate adjustment 	 N.C.	N.C.	○	○	○	○	○	
With by-pass  N.C. Double acting	 N.C. Double acting	N.C.	○	○	○	○	○	
		Double acting	○	○	○	○	○	
With flow rate adjustment & by-pass 	 N.C.	N.C.	○	○	○	○	○	
With indicator 	 N.C.	N.C.	○	○	○	○	○	
High back pressure 	 N.C.	N.C.	○	○	○	○	○	
With indicator & by-pass 	 N.C.	N.C.	○	○	○	○	○	

- LVLC
- LVA
- LVH
- LVLD
- LVQ**
- LVP
- LVW
- LQ1
- LQ3
- LVN
- LQHB
- TL
- TIL
- TLM
- TILM
- TD
- TID
- TH
- TIH

How to Order Space Saving Fittings

Applicable tubing size (Note 1) Note 2)

Size	No.	Applicable tubing size (mm)	Reducing
2	1	6 x 4	○
2	2	4 x 3	●
3	1	10 x 8	○
3	2	8 x 6	●
3	3	6 x 4	●
4	1	12 x 10	○
4	2	10 x 8	●
5	1	19 x 16	○
5	2	12 x 10	●
6	1	25 x 22	○
6	2	19 x 16	●

Size	Symbol	Applicable tubing size (inch)	Reducing
2	A	1/4" x 5/32"	○
2	B	3/16" x 1/8"	●
2	C	1/8" x 0.086"	●
3	A	3/8" x 1/4"	○
3	B	1/4" x 5/32"	●
4	A	1/2" x 3/8"	○
4	B	3/8" x 1/4"	●
5	A	3/4" x 5/8"	○
5	B	1/2" x 3/8"	●
6	A	1" x 7/8"	○
6	B	3/4" x 5/8"	●

○ Basic size ● With reducer

Note 1) Select the same size as the fitting on the valve.

Note 2) Refer to page 846 for details of the applicable tubing sizes.



LQ1 E 61 - SN - □
LQ2 E 21 - SN - □

• Packaging

Symbol	Packaging
Nil	Clean packaging equivalent to Class M3.5
1	Standard packaging equivalent to Class M5.5

• One (including insert bushing) of the nuts is not attached.

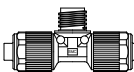
Fitting type

E	T
Union elbow 	Union tee 
P	U
Panel mount union 	Union 

Applicable tubing size (Note 1) Note 2)

Size	No.	Applicable tubing size (mm)	Reducing
2	1	6 x 4	○
2	2	4 x 3	●
3	1	10 x 8	○
3	2	8 x 6	●
3	3	6 x 4	●
4	1	12 x 10	○
4	2	10 x 8	●
5	1	19 x 16	○
5	2	12 x 10	●

Size	Symbol	Applicable tubing size (inch)	Reducing
2	A	1/4" x 5/32"	○
2	B	3/16" x 1/8"	●
2	C	1/8" x 0.086"	●
3	A	3/8" x 1/4"	○
3	B	1/4" x 5/32"	●
4	A	1/2" x 3/8"	○
4	B	3/8" x 1/4"	●
5	A	3/4" x 5/8"	○
5	B	1/2" x 3/8"	●

○ Basic size ● With reducer

Note 1) Select the same size as the fitting on the valve.

Note 2) Refer to page 846 for details of the applicable tubing sizes.

Piping Example

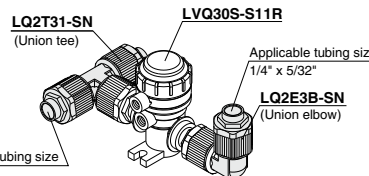

Ordering Example

LVQ30S-S11R 1

LQ2T31-SN (Union tee) 1

LQ2E3B-SN (Union elbow) 1

Note) For shipment, the valve and fittings are individually packaged and dispatched together in 1 box.



Standard Specifications

Model		LVQ20S	LVQ30S	LVQ40S	LVQ50S	LVQ60S
Connection fitting size		2	3	4	5	6
Fitting type	IN/OUT port	LQ1 or LQ2				LQ1
	Pilot port	LQ1				
Orifice diameter		ø4	ø8	ø10	ø16	ø22
Flow rate characteristics	Kv	0.3	1.1	1.6	4.2	6.8 (8.1) <small>Note 1)</small>
	Cv	0.35	1.3	1.9	5	8 (9.5) <small>Note 1)</small>
Withstand pressure (MPa)		1				
Operating pressure <A→B flow>	Standard	-98 kPa to 0.5 MPa <small>Note 3)</small>			-98 kPa to 0.4 MPa <small>Note 3)</small>	
	High temperature	-98 kPa to 0.3 MPa <small>Note 3)</small>				
Back pressure (MPa)	Standard	0.3 or less		0.2 or less		
	High back pressure	0.42 or less				
	High temperature	0.3 or less			0.2 or less	
Valve leakage (cm ³ /min)		0 (With water pressure)				
Pilot air pressure (MPa)		0.3 to 0.5 (High back pressure: 0.45 to 0.55)				
Pilot port size <small>Note 2)</small>		1/8" (ø3), ø4, Rc 1/8, NPT 1/8				
Fluid temperature (°C)	Standard	0 to 100				
	High temperature	0 to 170				
Ambient temperature (°C)		0 to 60				
Weight (kg)		0.085	0.175	0.223	0.725	0.835

Note 1) (): High flow type

Note 2) Refer to page 846 for details of the applicable tubing sizes.

Note 3) This product cannot be used for vacuum retention. Also, connecting the vacuum to the B port may reduce the life of the product.

⚠ Specific Product Precautions

Be sure to read this before handling the products. Refer to back page 50 for Safety Instructions and pages 845 and 846 for Air Operated Chemical Liquid Valve Precautions.

Piping

⚠ Caution

1. Take extra care with the insert bushing when connecting the fittings.
2. Tighten the nut until it touches the end surface of the body, and then tighten it an additional 1/8 turn. If the nut won't turn any further, then it means a sufficient tightening has occurred. Refer to the proper tightening torques shown below.

Tightening Torque for Piping

Body class	Torque (N·m)	
	LQ1	LQ2
2	0.3 to 0.4	1.5 to 2.0
3	0.8 to 1.0	3.0 to 3.5
4	1.0 to 1.2	7.5 to 9.0
5	2.5 to 3.0	11.0 to 13.0
6	5.5 to 6.0	—

Construction

Basic
N.C.

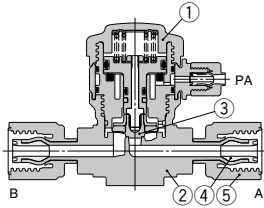

N.O.

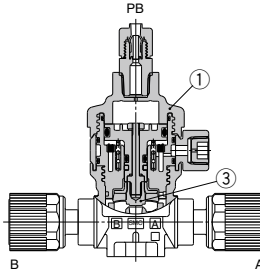

Double acting

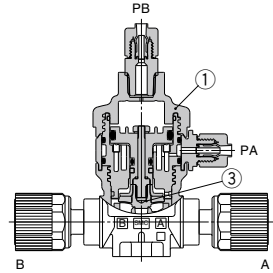

With flow rate adjustment

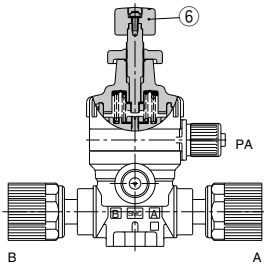

With by-pass

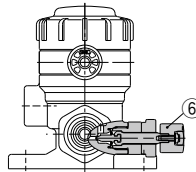

With indicator

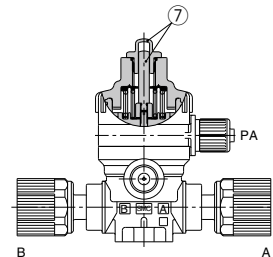

LVQ
LVA
LVH
LVQ
LVQ
LVP
LVW
LQ1
LQ3
LVN
LQHB
TL
TIL
TLM
TILM
TD
TID
TH
TIH

Component Parts

No.	Description	Material
1	Actuator	PVDF
2	Body	PFA
3	Diaphragm	PTFE
4	Insert bushing	PFA
5	Nut	PFA
6	Flow rate adjuster	PVDF
7	Indicator/Cover	PP

LVQS Series

Dimensions

Basic, High back pressure

N.C. valve

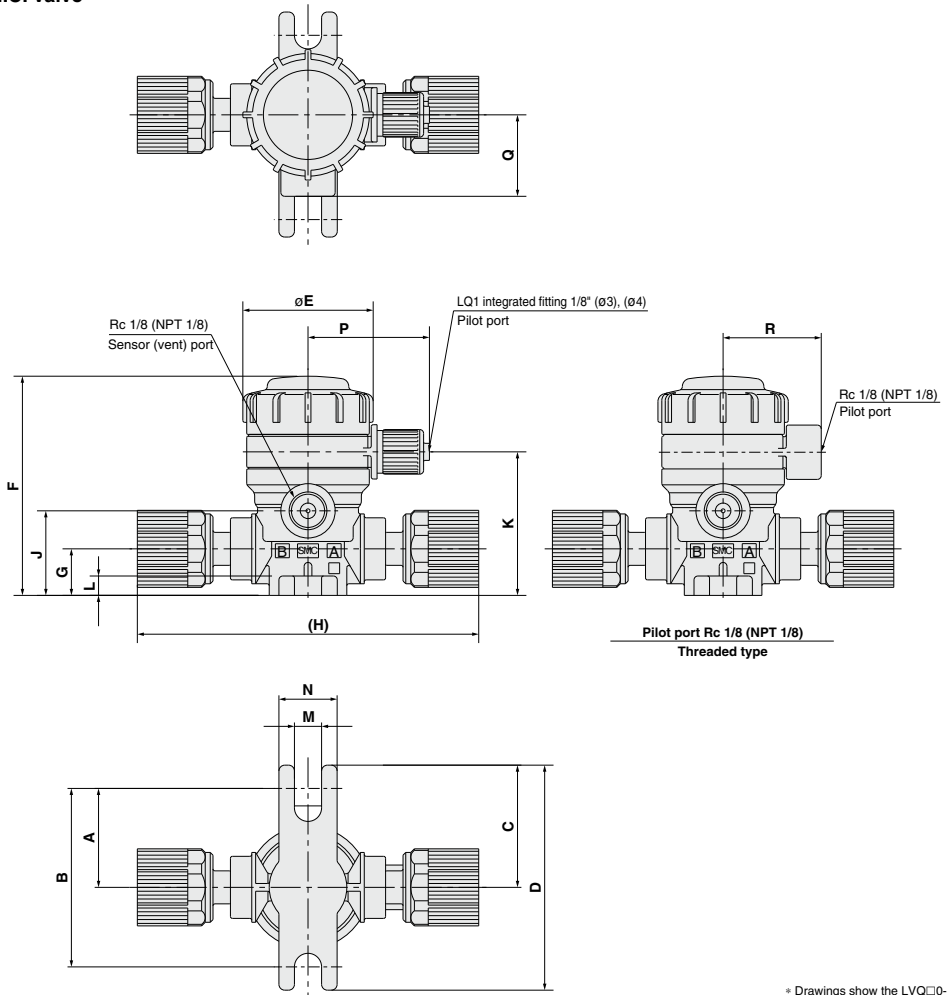

* Drawings show the LVQ□0-S.

LVQ□0S-V□□ Dimensions (N.C. Valve)

(mm)

Model	A	B	C	D	E	F	G	H		J	K	L	M	N	P	Q	R
								V□	S□								
LVQ20S-V ⁰ 07	25.5	46	31.5	58	33.6	56.5	12	89	92	21.8	37	5	7	15	31.3	21	25.3
LVQ30S-V ⁰ 11	28.5	57	34.5	69	45.4	77	16.5	106	112	32	50	6	7	20	37.2	25	31.2
LVQ40S-V ⁰ 13	28.5	57	34.5	69	45.4	82.5	22	120	126	37.5	55.5	6	7	20	37.2	25	31.2
LVQ50S-V ⁰ 19	42	84	48	96	75	127	25	164	168	50.2	78.2	10	7	20	50.8	38.5	45
LVQ60S-V25*	42	84	48	96	75	136.8	32	177	—	60	88	10	7	20	50.8	38.5	45

* The LVQ60 is available only with "V".

**With flow rate adjustment, High back pressure with flow rate adjustment
N.C. valve**

Dimensions (mm)	
Model	S
LVQ20S- $\frac{V}{S}$ 07-1	83
LVQ30S- $\frac{V}{S}$ 11-1	113.5
LVQ40S- $\frac{V}{S}$ 13-1	119
LVQ50S- $\frac{V}{S}$ 19-1	171.5
LVQ60S-V25-1*	182.5

* The LVQ60 is available only with "V".

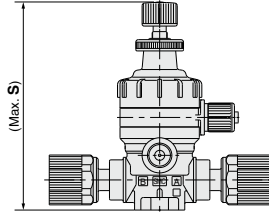

* Drawing shows the LVQ□0-S.

**With by-pass, High back pressure with by-pass
N.C. valve**

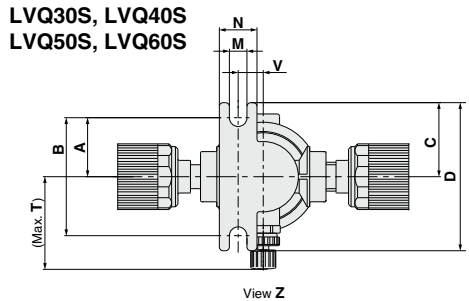
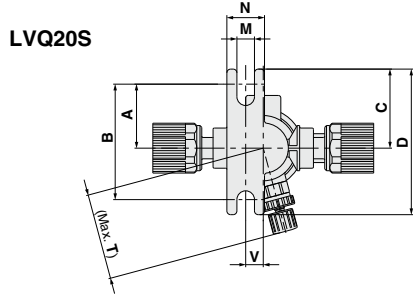
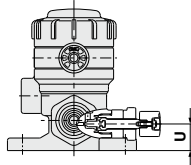
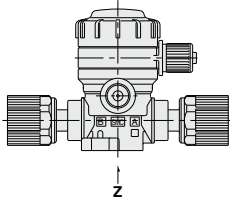
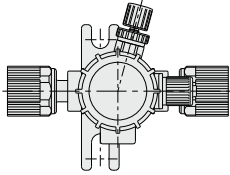

Dimensions (mm)										
Model	A	B	C	D	M	N	T	U	V	
LVQ20S- $\frac{V}{S}$ 07-2	25.5	46	31.5	58	7	15	34.3	10.6	7	
LVQ30S- $\frac{V}{S}$ 11-2	25.5	51	31.5	63	7	15	36.9	16.5	10	
LVQ40S- $\frac{V}{S}$ 13-2	25.5	51	31.5	63	7	15	37.9	22	10	
LVQ50S- $\frac{V}{S}$ 19-2	38	76	44	88	7	20	64	25	17	
LVQ60S-V25-2*	38	76	44	88	7	20	66	32	17	

* The LVQ60 is available only with "V".

* Drawings show the LVQ□0-S.

LVQ
LVA
LVH
LVQ
LVP
LVW
LQ1
LQ3
LVN
LQHB
TL
TIL
TLM
TILM
TD
TID
TH
TIH

LVQS Series

Dimensions

With flow rate adjustment & by-pass,
High back pressure with flow rate adjustment & by-pass
N.C. valve

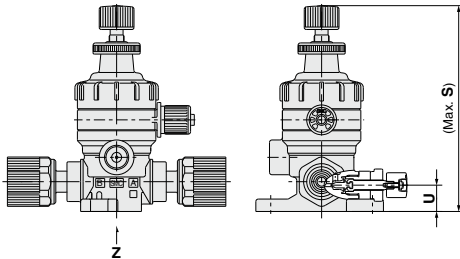
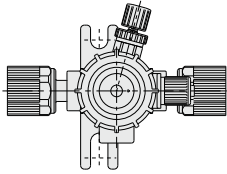

LVQ20S

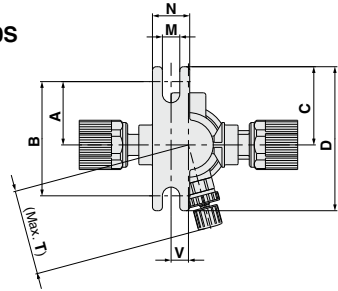

LVQ30S, LVQ40S
LVQ50S, LVQ60S

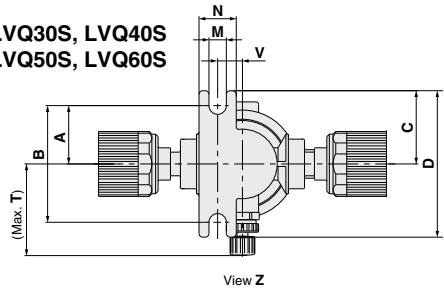

Dimensions

Model	A	B	C	D	M	N	S	T	U	V
LVQ20S- $\frac{1}{8}$ 07-3	25.5	46	31.5	58	7	15	83	34.3	10.6	7
LVQ30S- $\frac{1}{8}$ 11-3	25.5	51	31.5	63	7	15	113.5	36.9	16.5	10
LVQ40S- $\frac{1}{8}$ 13-3	25.5	51	31.5	63	7	15	119	37.9	22	10
LVQ50S- $\frac{1}{8}$ 19-3	38	76	44	88	7	20	171.5	64	25	17
LVQ60S-V25-3*	38	76	44	88	7	20	182.5	66	32	17

* The LVQ60 is available only with "V".

* Drawings show the LVQ□0-S.

With indicator, High back pressure with indicator
N.C. valve

Dimensions

Model	S
LVQ20S- $\frac{1}{8}$ 07-4	70.5
LVQ30S- $\frac{1}{8}$ 11-4	88.5
LVQ40S- $\frac{1}{8}$ 13-4	94
LVQ50S- $\frac{1}{8}$ 19-4	134.5
LVQ60S-V25-4*	144

* The LVQ60 is available only with "V".

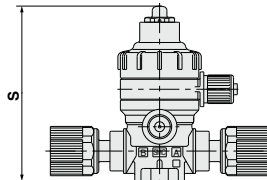

* Drawing shows the LVQ□0-S.

**Basic
N.O. valve**

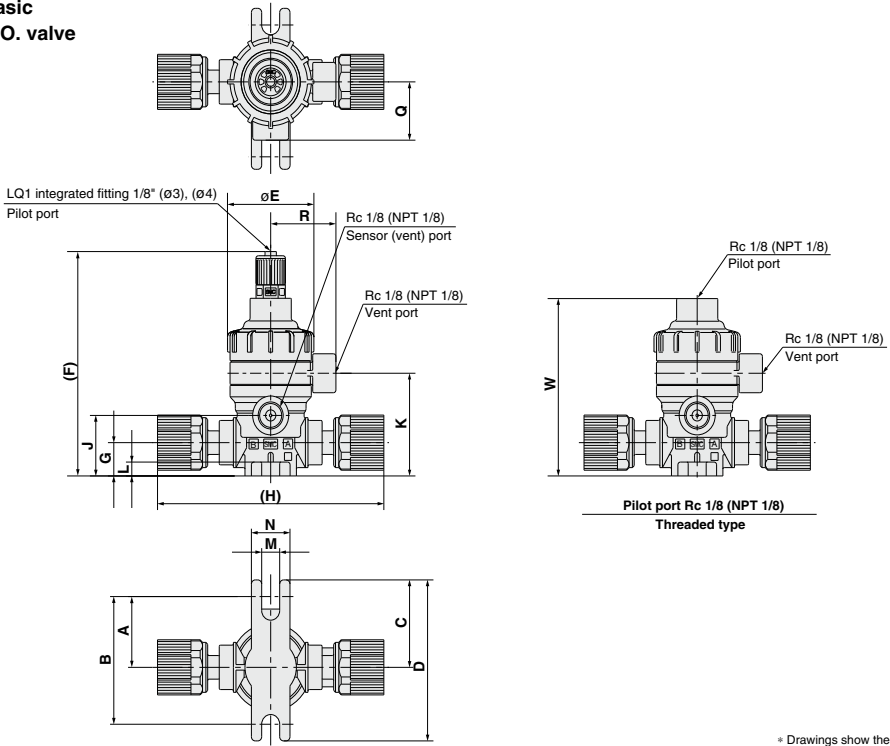

Double acting valve

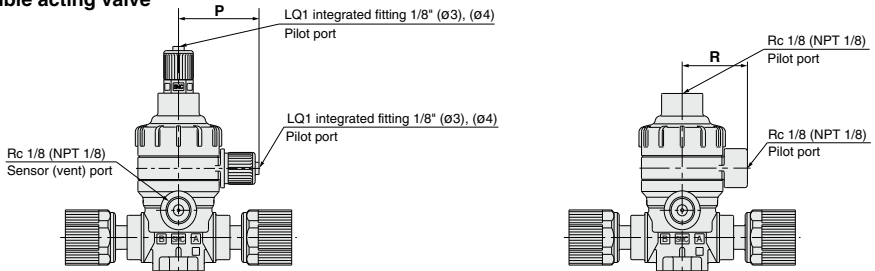

LVQ□S□ Dimensions (N.O. Valve, Double Acting Valve)

(mm)

Model	A	B	C	D	E	F	G	H		J	K	L	M	N	P	Q	R	W
								V□	S□									
LVQ2S-1107	25.5	46	31.5	58	33.6	81	12	89	92	21.8	37	5	7	15	31.3	21	25.3	64
LVQ3S-1111	28.5	57	34.5	69	45.4	99	16.5	106	112	32	50	6	7	20	37.2	25	31.2	82
LVQ4S-1113	28.5	57	34.5	69	45.4	104.5	22	120	126	37.5	55.5	6	7	20	37.2	25	31.2	87.5
LVQ5S-1119	42	84	48	96	75	145	25	164	168	50.2	78.2	10	7	20	50.8	38.5	45	128
LVQ6S-1125*	42	84	48	96	75	154.5	32	177	—	60	88	10	7	20	50.8	38.5	45	137.5

* The LVQ60 is available only with "V".

LVQS Series

Dimensions

With by-pass

Double acting valve

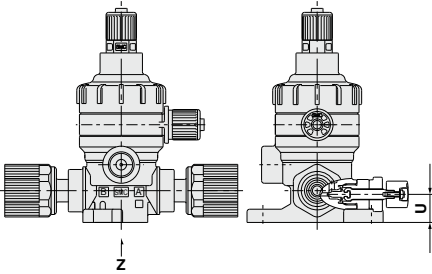
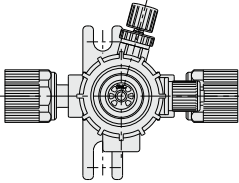

LVQ2 $\frac{1}{2}$ S

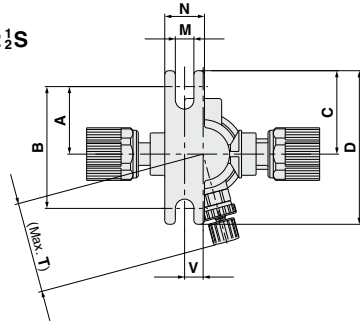

LVQ3 $\frac{1}{2}$ S, LVQ4 $\frac{1}{2}$ S
LVQ5 $\frac{1}{2}$ S, LVQ6 $\frac{1}{2}$ S

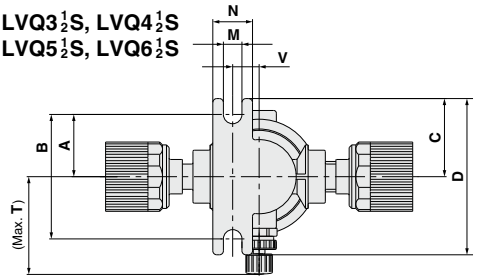

View Z

* Drawings show the LVQ□0-S.

Dimensions (N.O. Valve, Double Acting Valve) (mm)

Model	A	B	C	D	M	N	T	U	V
LVQ2 $\frac{1}{2}$ S- $\frac{1}{8}$ 07-2	25.5	46	31.5	58	7	15	34.3	10.6	7
LVQ3 $\frac{1}{2}$ S- $\frac{1}{8}$ 11-2	25.5	51	31.5	63	7	15	36.9	16.5	10
LVQ4 $\frac{1}{2}$ S- $\frac{1}{8}$ 13-2	25.5	51	31.5	63	7	15	37.9	22	10
LVQ5 $\frac{1}{2}$ S- $\frac{1}{8}$ 19-2	38	76	44	88	7	20	64	25	17
LVQ6 $\frac{1}{2}$ S-V25-2*	38	76	44	88	7	20	66	32	17

* The LVQ60 is available only with "V".

Manually Operated Insert Bushing, Integrated Fitting Type Hyper Fitting **LVQH Series**



How to Order

LVQH **2** 0 - **S** 07 - **1** -

Body class

Symbol	Body class	Orifice dia.
2	2	ø4
3	3	ø8
4	4	ø10
5	5	ø16
6	6	ø22

Option

Symbol	Option
Nil	None
K	Buffer material FFKM
N	For ammonium hydroxide

Note) Options cannot be combined each other.

Fitting type

Symbol	Fitting type	Body class
V	LQ1	2, 3, 4, 5, 6
S	LQ2	2, 3, 4, 5

Handle operation

Symbol	Body class
1	90° turn type
4	Multi-turn type (With indicator)

Vent port type

Symbol	Body class
Nil	Threaded NPT 1/8
R	Threaded Rc 1/8

Port B (OUT) different dia. size

Symbol	Application
Nil	Ports A & B same size

Refer to the applicable tubing table to the left.





Different diameter tubings can be selected within the same body class.

Applicable tubing size^{Note)}

Symbol	Connection tubing size	Body class					
		2	3	4	5	6	
Metric size							
03	3 x 2	●					
04	4 x 3	●					
06	6 x 4	○	●				
08	8 x 6		●				
10	10 x 8		○	●			
12	12 x 10			○	●		
19	19 x 16				○	●	
25	25 x 22					○	●
Inch size							
03	1/8" x 0.086"	●					
05	3/16" x 1/8"	●					
07	1/4" x 5/32"	○	●				
11	3/8" x 1/4"		○	●			
13	1/2" x 3/8"			○	●		
19	3/4" x 5/8"				○	●	
25	1" x 7/8"					○	●

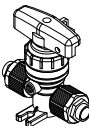
○ Basic size ● With reducer
Note) Refer to page B46 for details of the applicable tubing sizes.

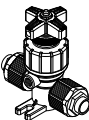
Variations

Type	Symbol	Model				
		Orifice diameter				
		LVQH20	LVQH30	LVQH40	LVQH50	LVQH60
		Metric				
		Inch				
		1/4	3/8	1/2	3/4	1
90° turn type 		○	○	○	○	○
		○	○	○	○	○
Multi-turn type 		○	○	○	○	○
		○	○	○	○	○

- LVC
- LVA
- LVH
- LVD
- LVQ**
- LVP
- LVW
- LQ1
- LQ3
- LVN
- LQHB
- TL
- TIL
- TLM
- TILM
- TD
- TID
- TH
- TIH

Standard Specifications



Model		LVQH20	LVQH30	LVQH40	LVQH50	LVQH60
Tubing O.D., ^{Note 1)}	Metric	6	10	12	19	25
	Inch	1/4	3/8	1/2	3/4	1
Fitting type		LQ1 or LQ2				
Orifice diameter		ø4	ø8	ø10	ø16	ø22
Flow rate characteristics	Kv	0.3	1.1	1.6	4.2	6.8
	Cv	0.35	1.3	1.9	5	8
Withstand pressure (MPa)		1				
Fluid pressure <A→B>		-98 kPa to 0.5 MPa ^{Note 2)}			-98 kPa to 0.4 MPa ^{Note 2)}	
Back pressure (MPa)		0.3 or less			0.2 or less	
Valve leakage (cm ³ /min)		0 (With water pressure)				
Fluid temperature (°C)		0 to 100				
Ambient temperature (°C)		0 to 60				
Weight (kg)	LVQH□0-1	0.12	0.27	0.31	1.10	1.16
	LVQH□0-4	0.11	0.20	0.22	0.67	0.87

Note 1) Refer to page 846 for details of the applicable tubing sizes.

Note 2) This product cannot be used for vacuum retention. Also, connecting the vacuum to the B port may reduce the life of the product.

⚠ Specific Product Precautions

Be sure to read this before handling the products. Refer to back page 50 for Safety Instructions and pages 845 and 846 for Air Operated Chemical Liquid Valve Precautions.

Piping

⚠ Caution

1. Connect tubing by special tools.

For information on tubing connection and special tools, please see the pamphlet "High Purity Fluoropolymer Fittings Hyper Fitting LQ1/2 Series Work Procedure Instructions" (M-E05-1). (The pamphlet can be downloaded from the SMC home page.)

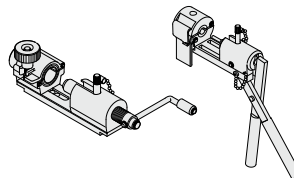

2. Tighten the nut until it touches the end surface of the body, and then tighten it an additional 1/8 turn. If the nut won't turn any further, then it means a sufficient tightening has occurred. Refer to the proper tightening torques shown below.

Tightening Torque for Piping

Body class	Torque (N·m)	
	LQ1	LQ2
2	0.3 to 0.4	1.5 to 2.0
3	0.8 to 1.0	3.0 to 3.5
4	1.0 to 1.2	7.5 to 9.0
5	2.5 to 3.0	11.0 to 13.0
6	5.5 to 6.0	—

Construction

90° turn type

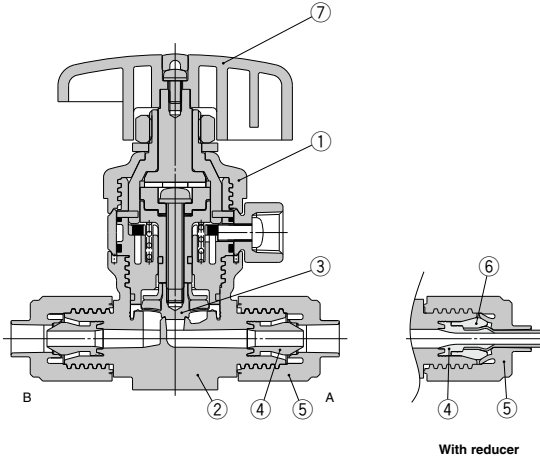

Multi-turn type (With indicator)

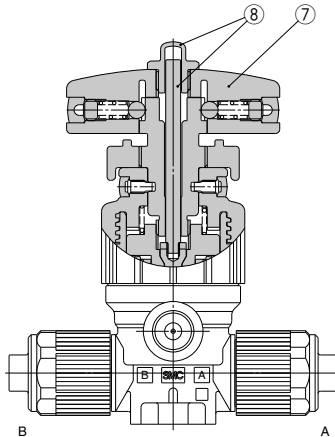

Component Parts

No.	Description	Material
1	Actuator	PVDF
2	Body	PFA
3	Diaphragm	PTFE
4	Insert bushing	PFA
5	Nut	PFA
6	Collar	PFA
7	Handle	PVDF
8	Indicator/Cover	PP

LVC
LVA
LVH
LVD
LVQ
LVP
LVW
LQ1
LQ3
LVN
LQHB
TL
TIL
TLM
TILM
TD
TID
TH
TIH

LVQH Series

Dimensions

90° turn type

Dimensions

Model	A	B	C	D	F	G	H (mm)	
							V□	S□
LVQH20- $\frac{V}{S}$ □-1	25.5	46	31.5	58	79	12	70	77
LVQH30- $\frac{V}{S}$ □-1	28.5	57	34.5	69	103	16.5	83	95
LVQH40- $\frac{V}{S}$ □-1	28.5	57	34.5	69	108	22	95	109
LVQH50- $\frac{V}{S}$ □-1	42	84	48	96	165	25	130	141
LVQH60-V□-1*	42	84	48	96	175	32	150	—

Model	J	K	L	M	N	Q	Y
LVQH20- $\frac{V}{S}$ □-1	21.8	37	5	7	15	21	55
LVQH30- $\frac{V}{S}$ □-1	32	50	6	7	20	25	80
LVQH40- $\frac{V}{S}$ □-1	37.5	55.5	6	7	20	25	80
LVQH50- $\frac{V}{S}$ □-1	50.2	78.2	10	7	20	38.5	110
LVQH60-V□-1*	60	88	10	7	20	38.5	110

* The LVQ60 is available only with "V".
 * Drawings show the LVQ□0-S.

Multi-turn type (With indicator)

Dimensions

Model	S	Y
LVQH20- $\frac{V}{S}$ □-4	93.6	50
LVQH30- $\frac{V}{S}$ □-4	111.2	50
LVQH40- $\frac{V}{S}$ □-4	116.7	50
LVQH50- $\frac{V}{S}$ □-4	170.7	71
LVQH60-V□-4*	180.2	71

* The LVQ60 is available only with "V".
 * Drawings show the LVQ□0-S.

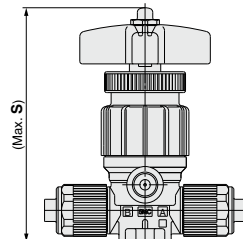
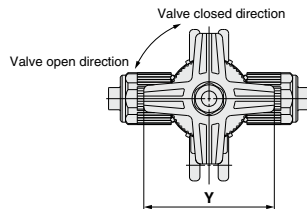
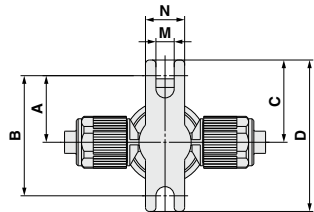
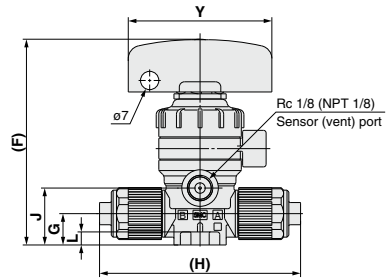
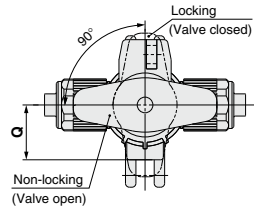

Manually Operated Insert Bushing, Integrated Fitting Type Space Saving/Space Saving Connection **LVQH Series**



How to Order

LVQH **2** 0 **S** - **S** **07** - **1** - **□**

Body class

Symbol	Body class	Orifice dia.
2	2	ø4
3	3	ø8
4	4	ø10
5	5	ø16
6	6	ø22

Body type

S	Space saving connection
----------	-------------------------

Fitting type

Symbol	Fitting type	Body class
V	LQ1	2, 3, 4, 5, 6
S	LQ2	2, 3, 4, 5

Option

Symbol	Option
Nil	None
K	Buffer material FFKM
N	For ammonium hydroxide

Note) Options cannot be combined each other.

Handle operation

1	90° turn type
4	Multi-turn type (With indicator)

Vent port type

Nil	Threaded	NPT 1/8
R	Threaded	Rc1/8

Applicable fitting size

Symbol	Fitting size	Body class					
		2	3	4	5	6	
07	2	○					
11	3		○				
13	4			○			
19	5				○		
25	6					○	

Note) Refer to page 800 for How to Order applicable fittings.
Select the same size as the fitting on the valve.

Variations

Model	Orifice diameter	Connection fitting size	LVQH20S	LVQH30S	LVQH40S	LVQH50S	LVQH60S
			Symbol	2	3	4	5
90° turn type			○	○	○	○	○
Multi-turn type			○	○	○	○	○

- LVC
- LVA
- LVH
- LVD
- LVQ**
- LVP
- LVW
- LQ1
- LQ3
- LVN
- LQHB
- TL
- TIL
- TLM
- TILM
- TD
- TID
- TH
- TIH

How to Order Space Saving Fittings

Applicable tubing size

Size	No.	Applicable tubing size (mm)	Reducing
2	1	6 x 4	○
2	2	4 x 3	●
3	1	10 x 8	○
3	2	8 x 6	●
3	3	6 x 4	●
4	1	12 x 10	○
4	2	10 x 8	○
5	1	19 x 16	○
5	2	12 x 10	●
6	1	25 x 22	○
6	2	19 x 16	●

Size	Symbol	Applicable tubing size (inch)	Reducing
2	A	1/4" x 5/32"	○
2	B	3/16" x 1/8"	●
2	C	1/8" x 0.086"	●
3	A	3/8" x 1/4"	○
3	B	1/4" x 5/32"	●
4	A	1/2" x 3/8"	○
4	B	3/8" x 1/4"	●
5	A	3/4" x 5/8"	○
5	B	1/2" x 3/8"	●
6	A	1" x 7/8"	○
6	B	3/4" x 5/8"	●

○ Basic size ● With reducer

Note 1) Select the same size as the fitting on the valve.



LQ1 E 61 - SN -
 LQ2 E 21 - SN -

Packaging

Symbol	Packaging
Nil	Clean packaging equivalent to Class M3.5
1	Standard packaging equivalent to Class M5.5

One (including insert bushing) of the nuts is not attached.

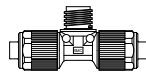
Fitting type

E	T
Union elbow 	Union tee 
P	U
Panel mount union 	Union 

Applicable tubing size

Size	No.	Applicable tubing size (mm)	Reducing
2	1	6 x 4	○
2	2	4 x 3	●
3	1	10 x 8	○
3	2	8 x 6	●
3	3	6 x 4	●
4	1	12 x 10	○
4	2	10 x 8	●
5	1	19 x 16	○
5	2	12 x 10	●

Size	Symbol	Applicable tubing size (mm)	Reducing
2	A	1/4" x 5/32"	○
2	B	3/16" x 1/8"	●
2	C	1/8" x 0.086"	●
3	A	3/8" x 1/4"	○
3	B	1/4" x 5/32"	●
4	A	1/2" x 3/8"	○
4	B	3/8" x 1/4"	●
5	A	3/4" x 5/8"	○
5	B	1/2" x 3/8"	●

○ Basic size ● With reducer

Note 1) Select the same size as the fitting on the valve.

Piping Example

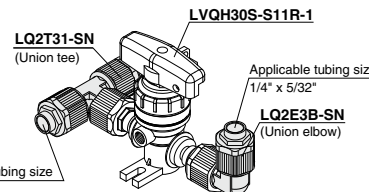

LVQH30S-S11R-1

LQ2T31-SN (Union tee)

Applicable tubing size 1/4" x 5/32"

LQ2E3B-SN (Union elbow)

Applicable tubing size 10 x 8

Ordering Example

LVQH30S-S11R-1 1

LQ2T31-SN (Union tee) 1

LQ2E3B-SN (Union elbow) 1

Note) For shipment, the valve and fittings are individually packaged and dispatched together in 1 box.

Standard Specifications



Model		LVQH20S	LVQH30S	LVQH40S	LVQH50S	LVQH60S
Connection fitting size		2	3	4	5	6
Fitting type		LQ1 or LQ2				LQ1
Orifice diameter		ø4	ø8	ø10	ø16	ø22
Flow rate characteristics	Kv	0.3	1.1	1.6	4.2	6.8
	Cv	0.35	1.3	1.9	5	8
Withstand pressure (MPa)		1				
Fluid pressure <A→B>		-98 kPa to 0.5 MPa ^{Note)}			-98 kPa to 0.4 MPa ^{Note)}	
Back pressure (MPa)		0.3 or less			0.2 or less	
Valve leakage (cm ³ /min)		0 (With water pressure)				
Fluid temperature (°C)		0 to 100				
Ambient temperature (°C)		0 to 60				
Weight (kg)	LVQH□0S-1	0.14	0.30	0.33	1.14	1.18
	LVQH□0S-4	0.13	0.23	0.24	0.71	0.89

Note) This product cannot be used for vacuum retention. Also, connecting the vacuum to the B port may reduce the life of the product.

⚠ Specific Product Precautions

Be sure to read this before handling the products. Refer to back page 50 for Safety Instructions and pages 845 and 846 for Air Operated Chemical Liquid Valve Precautions.

Piping

⚠ Caution

1. Take extra care with the insert bushing when connecting the fittings.
2. Tighten the nut until it touches the end surface of the body, and then tighten it an additional 1/8 turn. If the nut won't turn any further, then it means a sufficient tightening has occurred. Refer to the proper tightening torques shown below.

Tightening Torque for Piping

Body class	Torque (N·m)	
	LQ1	LQ2
2	0.3 to 0.4	1.5 to 2.0
3	0.8 to 1.0	3.0 to 3.5
4	1.0 to 1.2	7.5 to 9.0
5	2.5 to 3.0	11.0 to 13.0
6	5.5 to 6.0	—

LVC

LVA

LVH

LVD

LVQ

LVP

LVW

LQ1

LQ3

LVN

LQHB

TL
TIL

TLM
TILM

TD
TID

TH
TIH

LVQHS Series

Construction

90° turn type

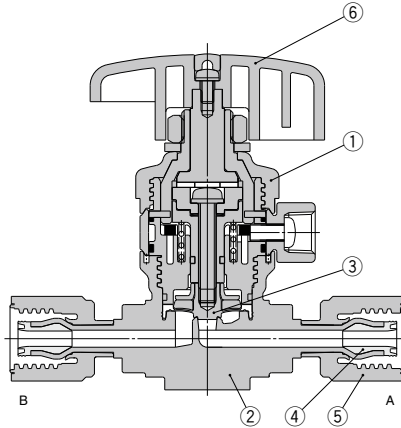

Multi-turn type (With indicator)

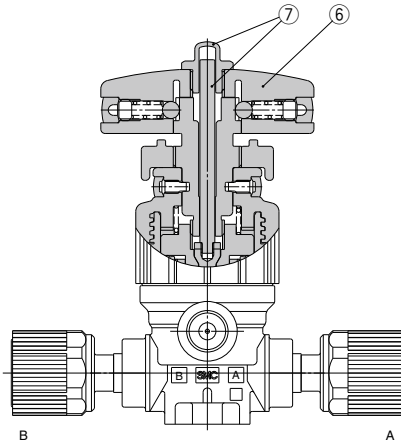

Component Parts

No.	Description	Material
1	Actuator	PVDF
2	Body	PFA
3	Diaphragm	PTFE
4	Insert bushing	PFA
5	Nut	PFA
6	Handle	PVDF
7	Indicator/Cover	PP

Dimensions

90° turn type

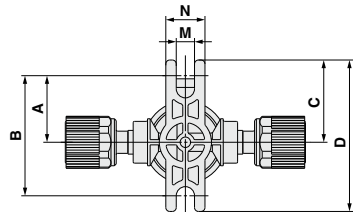
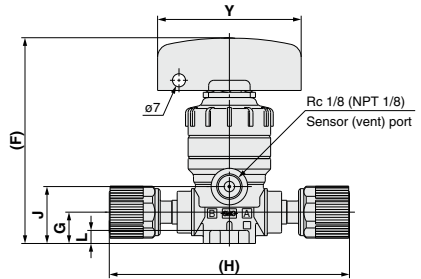
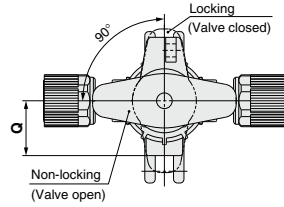

Dimensions

(mm)

Model	A	B	C	D	F	G	H	
							V□	S□
LVQH20S- $\frac{1}{8}$ □-1	25.5	46	31.5	58	79	12	89	92
LVQH30S- $\frac{1}{8}$ □-1	28.5	57	34.5	69	103	16.5	106	112
LVQH40S- $\frac{1}{8}$ □-1	28.5	57	34.5	69	108	22	120	126
LVQH50S- $\frac{1}{8}$ □-1	42	84	48	96	165	25	164	168
LVQH60S-V□-1*	42	84	48	96	175	32	177	—

Model	J	L	M	N	Q	Y
LVQH20S- $\frac{1}{8}$ □-1	21.8	5	7	15	21	55
LVQH30S- $\frac{1}{8}$ □-1	32	6	7	20	25	80
LVQH40S- $\frac{1}{8}$ □-1	37.5	6	7	20	25	80
LVQH50S- $\frac{1}{8}$ □-1	50.2	10	7	20	38.5	110
LVQH60S-V□-1*	60	10	7	20	38.5	110

* The LVQ60 is available only with "V".

* Drawings show the LVQ□0-S.

Multi-turn type (With indicator)

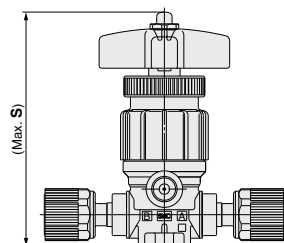
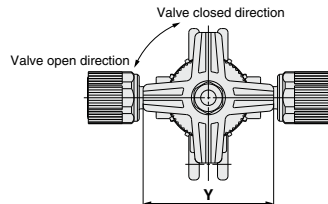

Dimensions

(mm)

Model	S	Y
LVQH20S- $\frac{1}{8}$ □-4	93.6	50
LVQH30S- $\frac{1}{8}$ □-4	111.2	50
LVQH40S- $\frac{1}{8}$ □-4	116.7	50
LVQH50S- $\frac{1}{8}$ □-4	170.7	71
LVQH60S-V□-4*	180.2	71

* The LVQ60 is available only with "V".

* Drawings show the LVQ□0-S.

LVQ

LVA

LVH

LVD

LVQ

LVP

LVW

LQ1

LQ3

LVN

LQHB

TL

TIL

TLM

TILM

TD

TID

TH

TIH

Fittings and Special Tools

Fittings

How to Change Tubing Sizes

The tubing size can be changed within the same body class (body size) by replacing the nut and insert bushing.

Body class	Connection tubing O.D.													
	Metric size						Inch size							
	4	6	8	10	12	19	25	1/8	3/16	1/4	3/8	1/2	3/4	1
2	●	○	—	—	—	—	—	●	●	○	—	—	—	—
3	—	●	●	○	—	—	—	—	—	●	○	—	—	—
4	—	—	—	●	○	—	—	—	—	—	●	○	—	—
5	—	—	—	—	●	○	—	—	—	—	—	●	○	—
6	—	—	—	—	—	●	○	—	—	—	—	—	●	○

Parts Composition

	Component parts		
	Nut	Insert	Collar (insert assembly)
○ Basic size	Yes	Yes	No
● Reducer type	Yes	Yes	Yes

⚠ Caution

1. Connect tubing by special tools.

For information on tubing connection and special tools, please see the pamphlet "High Purity Fluoropolymer Fittings Hyper Fitting LQ1/2 Series Work Procedure Instructions" (M-E05-1). (The pamphlet can be downloaded from the SMC home page.)

Changing the tubing size

Example) Changing the tubing from an O.D. 1/4" to O.D. 1/8" within the body class 2.

Prepare an insert bushing and nut for 1/8" O.D. tubing (LQ-2U03) and change the tubing size.

(Refer to How to Order Fitting Parts.)

Note) Tubing is sold separately.

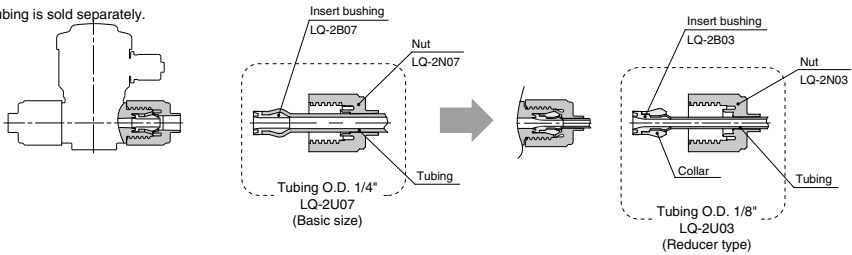

How to Order Fitting Parts

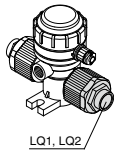

LQ 2 **U** 03 * U type is recommended when changing tubing sizes.

Fitting type

Symbol	Applicable fitting
Nil	LQ2
1	LQ1

Body class (fittings)

Symbol	Body class (fittings)	Applicable fitting
2	2	LQ1 LQ2
3	3	
4	4	LQ1
5	5	
6	6	LQ1

Parts type

Symbol	Parts type
U	Nut & Insert bushing
B	Insert bushing
N	Nut

Tubing size^{Note)}

Symbol	Tubing size	Body class (fittings)	Applicable fitting
03	1/8" x 0.086"(3 x 2)	2	LQ1 LQ2
04	4 x 3		
05	3/16" x 1/8"		
06	6 x 4		
07	1/4" x 5/32"		
06	6 x 4		
08	8 x 6		
10	10 x 8	3	LQ1
07	1/4" x 5/32"		
11	3/8" x 1/4"		

Symbol	Tubing size	Body class (fittings)	Applicable fitting
10	10 x 8	4	LQ1 LQ2
12	12 x 10		
11	3/8" x 1/4"		
13	1/2" x 3/8"		
12	12 x 10	5	LQ1
13	1/2" x 3/8"		
19	3/4" x 5/8", 19 x 16		
19	3/4" x 5/8", 19 x 16	6	LQ1
25	1" x 7/8", 25 x 22		

For pilot port

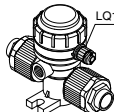

LQ1 1 **U** 03

Body class (fittings)

Symbol	Body class (fittings)	Applicable fitting
1	1	LQ1

Parts type

Symbol	Parts type
U	Nut & Insert bushing
B	Insert bushing
N	Nut

Tubing size^{Note 1) Note 2)}

Symbol	Tubing size	Body class (fittings)
03	1/8" x 0.086"(3 x 2)	1
04	4 x 3	

Note 1) Cannot change to tubing with different diameter.
Note 2) Refer to page 846 for details of the applicable tubing sizes.

Air Operated Flare, Integrated Fitting Type Hyper Fitting **LVQ-Z Series**



How to Order

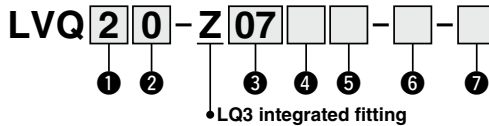

1 Body class

Symbol	Body class	Orifice dia.
2	2	ø4
3	3	ø8
4	4	ø10
5	5	ø16
6	6	ø22

4 Pilot port type

Symbol	Fitting	Connection tubing size
NII	With LQ3 fitting	1/8" x 0.086" (3 x 2) ^(Note)
M	With LQ3 fitting	Connection tubing size 4 x 3 ^(Note)
R	Threaded	Rc1/8
N	Threaded	NPT1/8

Note) Refer to page 846 for details of the applicable tubing sizes.

2 Valve type

0	N.C.
1	N.O.
2	Double acting

Note) For valve type combinations, refer to variations on the next page.

5 Pilot port direction

Symbol	Direction
NII	1
P2	2
P3	3
P4	4
P5	5
P6	6
P7	7
P8	8

Pilot port piping direction

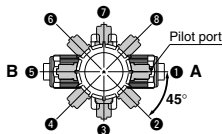

* Specify the piping direction by part number when ordering the product. Do not change the pilot port direction. (Refer to Precautions on page 846.)

3 Applicable tubing size^(Note)

Symbol	Connection tubing size	Body class					
		2	3	4	5	6	
Metric size							
03	3 x 2	○					
04	4 x 3	○					
06	6 x 4	○					
08	8 x 6		○				
10	10 x 8		○				
12	12 x 10			○			
19	19 x 16				○		
25	25 x 22					○	
Inch size							
03	1/8" x 0.086"	○					
07	1/4" x 5/32"	○					
11	3/8" x 1/4"		○				
13	1/2" x 3/8"			○			
19	3/4" x 5/8"				○		
25	1" x 7/8"					○	

Note) Refer to page 846 for details of the applicable tubing sizes.

6 Option 1

NII	None
1	With flow rate adjustment
2	With by-pass
3	With flow rate adjustment & by-pass
4	With indicator
5	High back pressure (0.42 MPa)
6	High back pressure with flow rate adjustment
7	High back pressure with by-pass
8	High back pressure with flow rate adjustment & by-pass
9	High back pressure with indicator
24	With indicator & by-pass









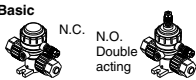
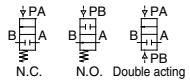

Note) Refer to variations in the table below for valve type and option 1 combinations. Options in the same table can not be combined each other.

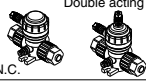
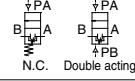
7 Option 2

Symbol	Applicable option										Note
	1	2	3	4	5	6	7	8	9	24	
NII	○	○	○	○	○	○	○	○	○	○	—
J	○	—	—	—	—	—	—	—	—	—	For high temperature
K	○	○	○	○	○	○	○	○	○	○	Buffer material FFKM
N	○	○	○	○	○	○	○	○	○	○	For ammonium hydroxide
P	—	—	—	○	○	—	—	—	—	—	High flow type LVQ6□ only

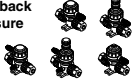
Note 1) Options 2 in the same table cannot be combined each other.
Note 2) High back pressure specifications (5 to 9) in Option 1 and high temperature specification (J) in Option 2 cannot be combined.

Variations

Type	Symbol	Model	Orifice diameter				
			LVQ20	LVQ30	LVQ40	LVQ50	LVQ60
			ø4	ø8	ø10	ø16	ø22
Type	Symbol	Valve type	Tubing O.D.				
			Metric				
			1/4	3/8	1/2	3/4	1
Type	Symbol	Valve type	Inch				
			Metric				
			1/4	3/8	1/2	3/4	1
Basic  N.C. N.O. Double acting	 N.C. N.O. Double acting	N.C.	○	○	○	○	○
		N.O.	○	○	○	○	○
		Double acting	○	○	○	○	○
With flow rate adjustment  N.C.	 N.C.	N.C.	○	○	○	○	○
With by-pass  N.C. Double acting	 N.C. Double acting	N.C.	○	○	○	○	○
		Double acting	○	○	○	○	○
With flow rate adjustment & by-pass  N.C.	 N.C.	N.C.	○	○	○	○	○
With indicator  N.C.	 N.C.	N.C.	○	○	○	○	○
High back pressure  N.C.	 N.C.	N.C.	○	○	○	○	○
With indicator & by-pass  N.C.	 N.C.	N.C.	○	○	○	○	○

- LVC
- LVA
- LVH
- LVD
- LVQ**
- LVP
- LVW
- LQ1
- LQ3
- LVN
- LQHB
- TL
- TIL
- TLM
- TID
- TIH



Standard Specifications

Model		LVQ20	LVQ30	LVQ40	LVQ50	LVQ60
Tubing O.D. ^{Note 1)}	Metric	6	10	12	19	25
	Inch	1/4	3/8	1/2	3/4	1
Orifice diameter		ø4	ø8	ø10	ø16	ø22
Flow rate characteristics	Kv	0.3	1.1	1.6	4.2	6.8 (8.1) ^{Note 2)}
	Cv	0.35	1.3	1.9	5	8 (9.5) ^{Note 2)}
Withstand pressure (MPa)		1				
Operating pressure <A→B flow>	Standard	-98 kPa to 0.5 MPa ^{Note 3)}			-98 kPa to 0.4 MPa ^{Note 3)}	
	High temperature	-98 kPa to 0.3 MPa ^{Note 3)}				
Back pressure (MPa)	Standard	0.3 or less		0.2 or less		
	High back pressure	0.42 or less				
	High temperature	0.3 or less		0.2 or less		
Valve leakage (cm ³ /min)		0 (With water pressure)				
Pilot air pressure (MPa)		0.3 to 0.5 (High back pressure: 0.45 to 0.55)				
Pilot port size		1/8" (ø3), Rc 1/8, NPT 1/8				
Fluid temperature (°C)	Standard	0 to 100				
	High temperature	0 to 170				
Ambient temperature (°C)		0 to 60				
Weight (kg)		0.08	0.18	0.22	0.72	0.87

Note 1) Refer to page 846 for details of the applicable tubing sizes.

Note 2) (): High flow type

Note 3) This product cannot be used for vacuum retention. Also, connecting the vacuum to the B port may reduce the life of the product.

⚠ Specific Product Precautions

Be sure to read this before handling the products. Refer to back page 50 for Safety Instructions and pages 845 and 846 for Air Operated Chemical Liquid Valve Precautions.

Piping

⚠ Caution

1. Connect tubing by special tools.

For information on tubing fittings and special tools, please see the pamphlet "High Purity Fluoropolymer Fittings Hyper Fitting/Flare Type LQ3 Series Fitting Procedure" (M-E06-4). (The pamphlet can be downloaded from the SMC home page.)

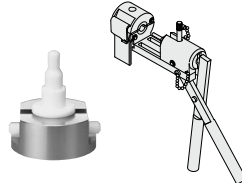

2. Tighten the nut until it touches the end surface of the body, and then tighten it an additional 1/8 turn. If the nut won't turn any further, then it means a sufficient tightening has occurred. Refer to the proper tightening torques shown below.

Tightening Torque for Piping

Body class	Torque (N·m)
2	1.6 to 1.8
3	3.2 to 3.5
4	5.0 to 5.3
5	10.0 to 10.5
6	22.5 to 23.0

Construction

Basic

N.C.

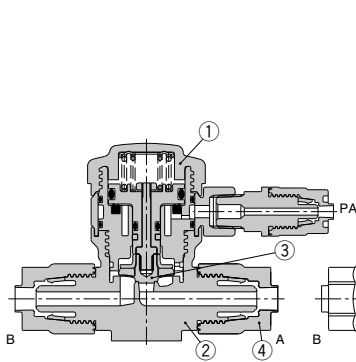

N.O.

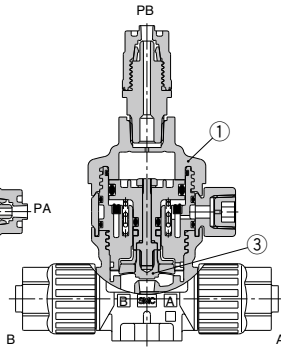

Double acting

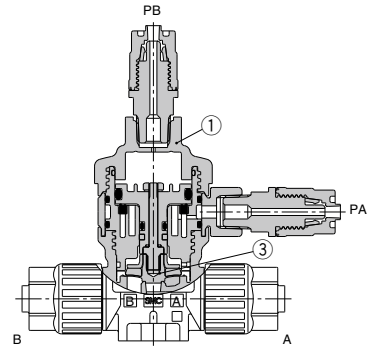

With flow rate adjustment

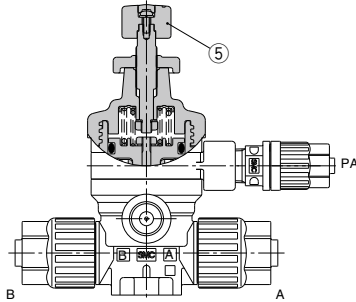

With by-pass

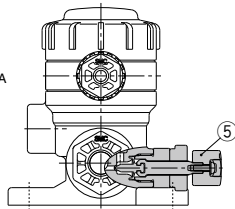

With indicator

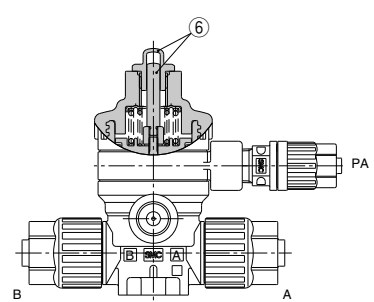

Component Parts

No.	Description	Material
1	Actuator	PVDF
2	Body	PFA
3	Diaphragm	PTFE
4	Nut	PFA
5	Flow rate adjuster	PVDF
6	Indicator/Cover	PP

LVC
LVA
LVH
LVD
LVQ
LVP
LVW
LQ1
LQ3
LVN
LQHB
TL
TIL
TLM
TILM
TD
TID
TH
TIH

LVQ-Z Series

Dimensions

Basic, High back pressure

N.C. valve

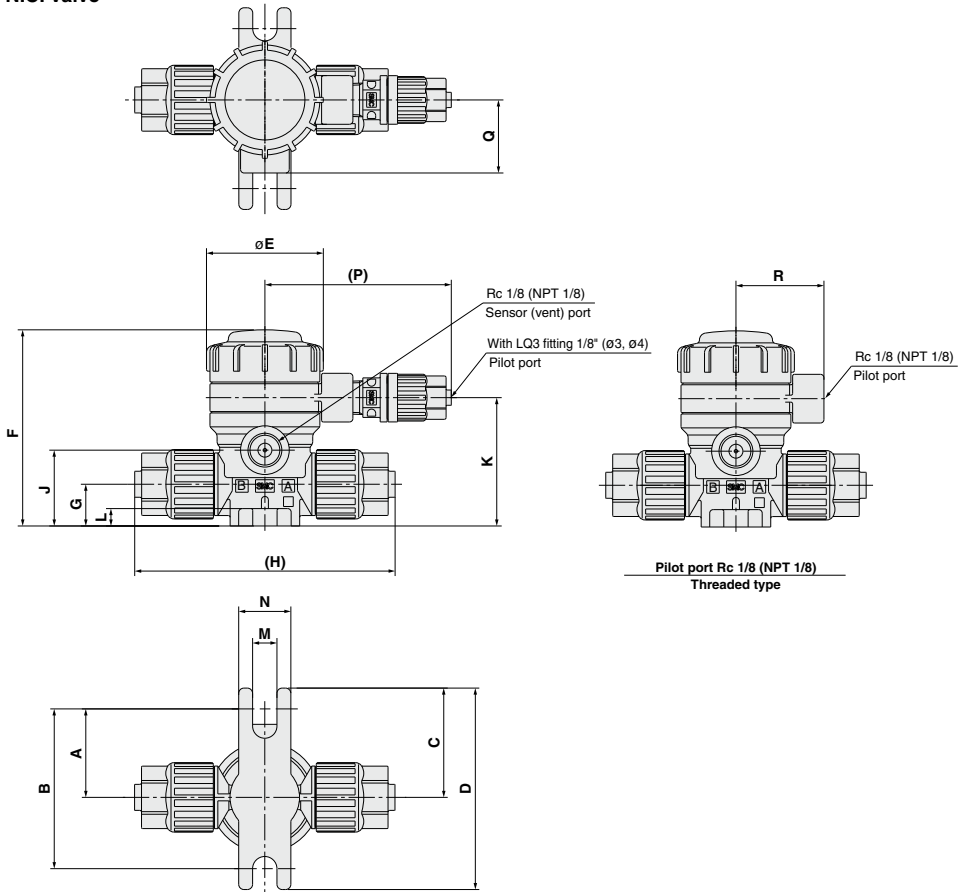

LVQ□0-Z□□□ Dimensions (N.C. Valve)

Model	A	B	C	D	E	F	G	H	J	K	L	M	N	P	Q	R
LVQ20-Z□□□	25.5	46	31.5	58	33.6	56.5	12	75	21.8	37	5	7	15	53.5	21	25.3
LVQ30-Z□□□	28.5	57	34.5	69	45.4	77	16.5	103	32	50	6	7	20	59.5	25	31.2
LVQ40-Z□□□	28.5	57	34.5	69	45.4	82.5	22	114	37.5	55.5	6	7	20	59.5	25	31.2
LVQ50-Z□□□	42	84	48	96	75	127	25	150	50.2	78.2	10	7	20	73	38.5	45
LVQ60-Z□□□	42	84	48	96	75	136.8	32	167	60	88	10	7	20	73	38.5	45

With flow rate adjustment
N.C. valve

Dimensions (mm)

Model	S
LVQ20-Z□□-1	83
LVQ30-Z□□-1	113.5
LVQ40-Z□□-1	119
LVQ50-Z□□-1	171.5
LVQ60-Z□□-1	182.5

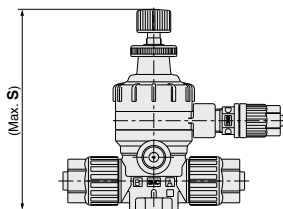

With by-pass
N.C. valve

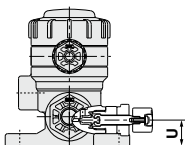
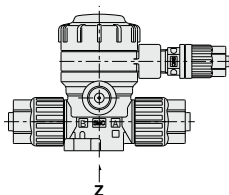
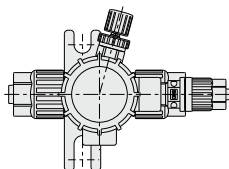

LVQ20

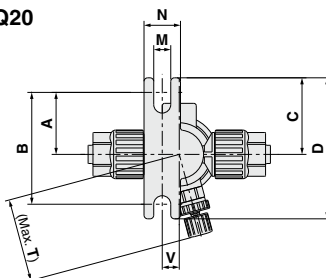

LVQ30, LVQ40
LVQ50, LVQ60

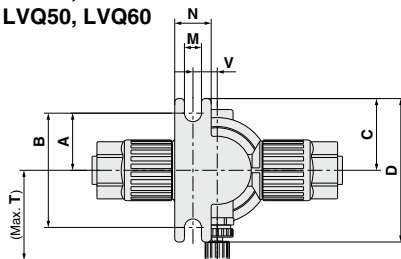

View Z

Dimensions (mm)

Model	A	B	C	D	M	N	T	U	V
LVQ20-Z□□-2	25.5	46	31.5	58	7	15	34.3	10.6	7
LVQ30-Z□□-2	25.5	51	31.5	63	7	15	36.9	16.5	10
LVQ40-Z□□-2	25.5	51	31.5	63	7	15	37.9	22	10
LVQ50-Z□□-2	38	76	44	88	7	20	64	25	17
LVQ60-Z□□-2	38	76	44	88	7	20	66	32	17

LVC
LVA
LVH
LVD
LVQ
LVP
LVW
LQ1
LQ3
LVN
LQHB
TL
TIL
TLM
TILM
TD
TID
TH
TIH

LVQ-Z Series

Dimensions

With flow rate adjustment & by-pass

N.C. valve

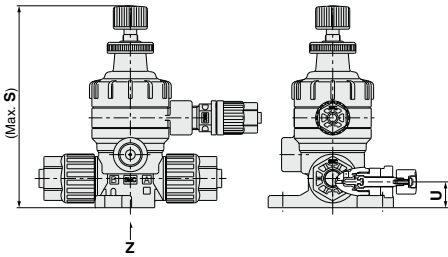
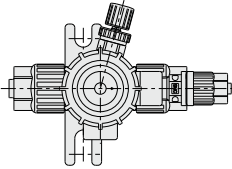

LVQ20

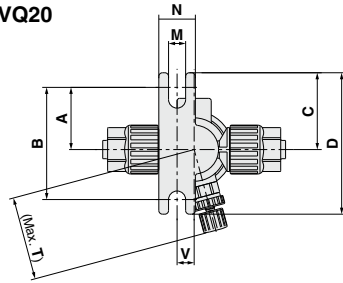

LVQ30, LVQ40
LVQ50, LVQ60

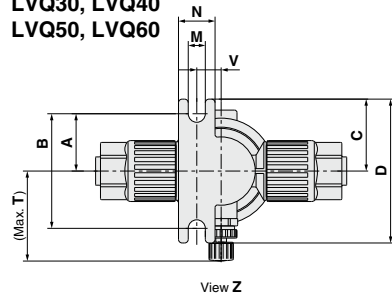

Dimensions

(mm)

Model	A	B	C	D	M	N	S	T	U	V
LVQ20-Z□□-3	25.5	46	31.5	58	7	15	83	34.3	10.6	7
LVQ30-Z□□-3	25.5	51	31.5	63	7	15	113.5	36.9	16.5	10
LVQ40-Z□□-3	25.5	51	31.5	63	7	15	119	37.9	22	10
LVQ50-Z□□-3	38	76	44	88	7	20	171.5	64	25	17
LVQ60-Z□□-3	38	76	44	88	7	20	182.5	66	32	17

With indicator

N.C. valve

Dimensions

(mm)

Model	S
LVQ20-Z□□-4	70.5
LVQ30-Z□□-4	88.5
LVQ40-Z□□-4	94
LVQ50-Z□□-4	134.5
LVQ60-Z□□-4	144

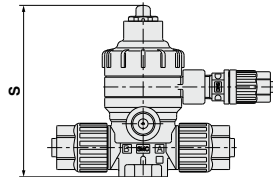

Basic
N.O. valve

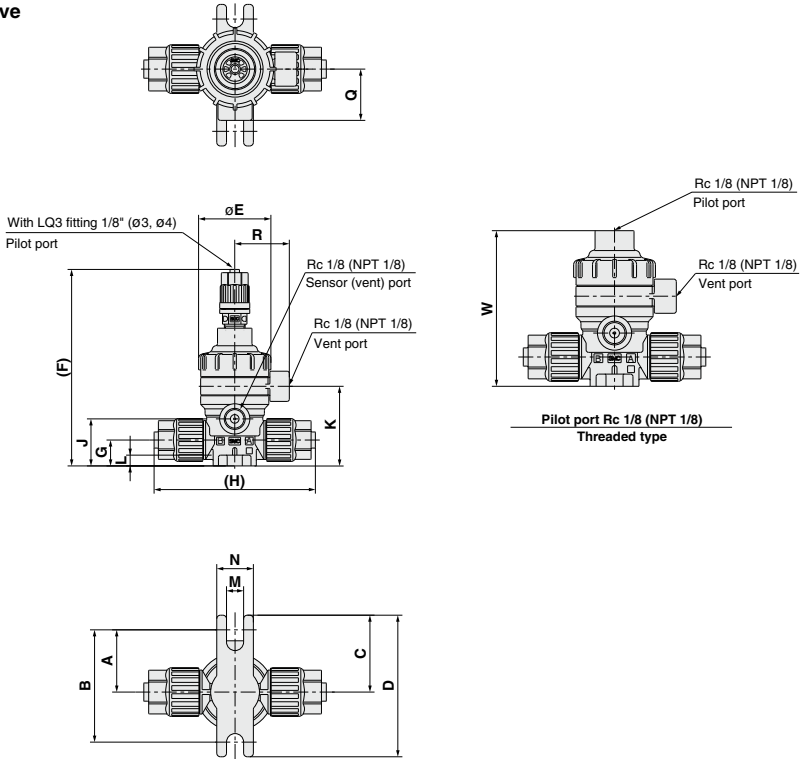

Double acting valve

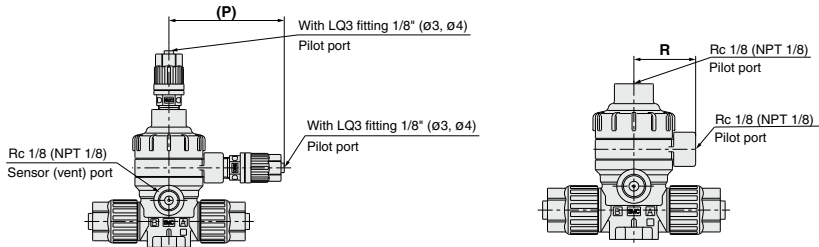

LVQ□₂-Z□□□ Dimensions (N.O. Valve, Double Acting Valve)

Model	A	B	B	D	E	F	G	H	J	K	L	M	N	P	Q	R	W
LVQ2 ₂ -Z□□□	25.5	46	31.5	58	33.6	89.5	12	75	21.8	37	5	7	15	53.5	21	25.3	64
LVQ3 ₂ -Z□□□	28.5	57	34.5	69	45.4	107.5	16.5	103	32	50	6	7	20	59.5	25	31.2	82
LVQ4 ₂ -Z□□□	28.5	57	34.5	69	45.4	113	22	114	37.5	55.5	6	7	20	59.5	25	31.2	87.5
LVQ5 ₂ -Z□□□	42	84	48	96	75	153.2	25	150	50.2	78.2	10	7	20	73	38.5	45	128
LVQ6 ₂ -Z□□□	42	84	48	96	75	163	32	167	60	88	10	7	20	73	38.5	45	137.5

LVC
LVA
LVH
LVD
LVQ
LVP
LVW
LQ1
LQ3
LVN
LQHB
TL
TIL
TLM
TILM
TD
TID
TH
TIH

LVQ-Z Series

Dimensions

With by-pass

Double acting valve

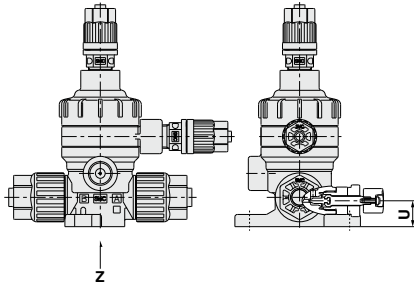
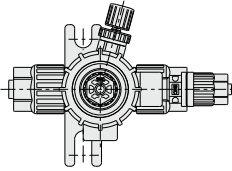

LVQ2_{1/2}

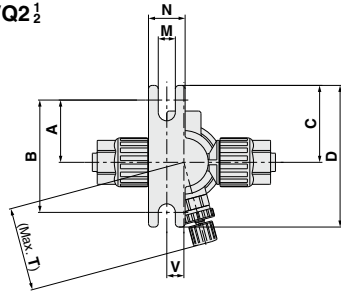

LVQ3_{1/2}, LVQ4_{1/2}
LVQ5_{1/2}, LVQ6_{1/2}

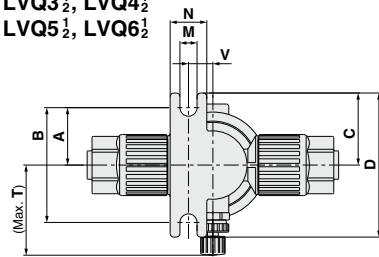

View Z

Dimensions (N.O Valve, Double Acting Valve)

(mm)

Model	A	B	C	D	M	N	T	U	V
LVQ2 _{1/2} -Z□□-2	25.5	46	31.5	58	7	15	34.3	10.6	7
LVQ3 _{1/2} -Z□□-2	25.5	51	31.5	63	7	15	36.9	16.5	10
LVQ4 _{1/2} -Z□□-2	25.5	51	31.5	63	7	15	37.9	22	10
LVQ5 _{1/2} -Z□□-2	38	76	44	88	7	20	64	25	17
LVQ6 _{1/2} -Z□□-2	38	76	44	88	7	20	66	32	17

Air Operated Flare, Integrated Fitting Type Space Saving/Space Saving Connection **LVQS-Z Series**

RoHS

How to Order

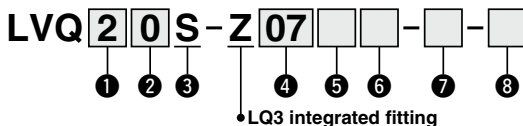

1 Body class

Symbol	Body class	Orifice dia.
2	2	ø4
3	3	ø8
4	4	ø10
5	5	ø16
6	6	ø22

2 Valve type

0	N.C.
1	N.O.
2	Double acting

Note) For valve type combinations, refer to variations on the next page.

3 Body type

S	Space saving connection
---	-------------------------

4 Applicable fitting size

Symbol	Fitting size	Body class					
		2	3	4	5	6	
07	2	○					
11	3		○				
13	4			○			
19	5				○		
25	6					○	

Note) Refer to page 814 for How to Order fitting parts. Select a tube with the same size as the valve side fitting.

5 Pilot port type

Nil	With LQ3 fitting	Connection tubing size 1/8" x 0.086" (3 x 2) ^(Note)
M	With LQ3 fitting	Connection tubing size 4 x 3 ^(Note)
R	Threaded	Rc1/8
N	Threaded	NPT1/8

Note) Refer to page 846 for details of the applicable tubing sizes.

6 Pilot port direction

Symbol	Direction
Nil	1
P2	2
P3	3
P4	4
P5	5
P6	6
P7	7
P8	8

Pilot port piping direction

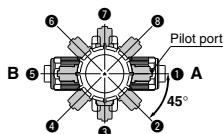

* Specify the piping direction by part number when ordering the product. Do not change the pilot port direction. (Refer to Precautions on page 846.)

7 Option 1

Nii	None
1	With flow rate adjustment
2	With by-pass
3	With flow rate adjustment & by-pass
4	With indicator
5	High back pressure (0.42 MPa)
6	High back pressure with flow rate adjustment
7	High back pressure with by-pass
8	High back pressure with flow rate adjustment & by-pass
9	High back pressure with indicator
24	With indicator & by-pass









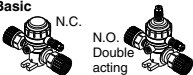
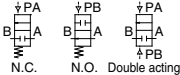

Note) Refer to variations in the table below for valve type and option 1 combinations. Options in the same table can not be combined each other.

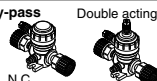
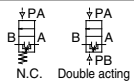
8 Option 2

Symbol	Applicable option										Note
	1	2	3	4	5	6	7	8	9	24	
Nii	○	○	○	○	○	○	○	○	○	○	—
J	○	—	—	—	—	—	—	—	—	—	For high temperature
K	○	○	○	○	○	○	○	○	○	○	Buffer material FFKM
N	○	○	○	○	○	○	○	○	○	○	For ammonium hydroxide
P	—	—	—	○	○	—	—	—	—	—	High flow type LVQ6□ only

Note 1) Options 2 in the same table cannot be combined each other.
Note 2) High back pressure specifications (5 to 9) in Option 1 and high temperature specification (J) in Option 2 cannot be combined.

Variations

Type	Symbol	Model	LVQ20S	LVQ30S	LVQ40S	LVQ50S	LVQ60S	
			Orifice diameter	ø4	ø8	ø10	ø16	ø22
			Connection fitting size	2	3	4	5	6
Basic 		N.C.	○	○	○	○	○	
		N.O.	○	○	○	○	○	
		Double acting	○	○	○	○	○	
With flow rate adjustment 		N.C.	○	○	○	○	○	
With by-pass 		N.C.	○	○	○	○	○	
		Double acting	○	○	○	○	○	
With flow rate adjustment & by-pass 		N.C.	○	○	○	○	○	
With indicator 		N.C.	○	○	○	○	○	
High back pressure 		N.C.	○	○	○	○	○	
With indicator & by-pass 		N.C.	○	○	○	○	○	

- LVQ
- LVA
- LVH
- LVQ
- LVP
- LVW
- LQ1
- LQ3
- LVN
- LQHB
- TL
- TIL
- TLM
- TILM
- TD
- TID
- TH
- TIH

How to Order Space Saving Fittings

LQ3 E 6A - SN -

• **Packaging**

Symbol	Packaging
Nil	Clean packaging equivalent to Class M3.5
1	Standard packaging equivalent to Class M5.5

• **One of the nuts is not attached.**

• **Fitting type**

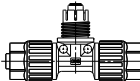
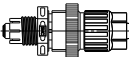
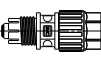
E	T
Union elbow 	Union tee 
P	U
Panel mount union 	Union 

• **Applicable tubing size** (Note 1) Note 2)

Size	Symbol	Applicable tubing size (mm)
2	1	6 x 4
3	1	10 x 8
3	2	8 x 6
4	1	12 x 10
5	1	19 x 16
6	1	25 x 22

Size	Symbol	Applicable tubing size (inch)
2	A	1/4" x 5/32"
3	A	3/8" x 1/4"
4	A	1/2" x 3/8"
5	A	3/4" x 5/8"
6	A	1" x 7/8"

Note 1) Select the same size as the fitting on the valve.

Note 2) Refer to page 846 for details of the applicable tubing sizes.

Piping Example

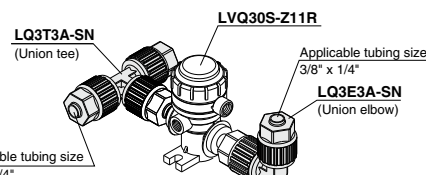

LQ3T3A-SN
(Union tee)

LVQ30S-Z11R

Applicable tubing size
3/8" x 1/4"

LQ3E3A-SN
(Union elbow)

Applicable tubing size
3/8" x 1/4"

Ordering Example

LVQ30S-Z11R 1

LQ3T3A-SN (Union tee) 1

LQ3E3A-SN (Union elbow) 1

Note) For shipment, the valve and fittings are individually packaged and dispatched together in 1 box.

Standard Specifications



Model	LVQ20S	LVQ30S	LVQ40S	LVQ50S	LVQ60S	
Connection fitting size	2	3	4	5	6	
Orifice diameter	ø4	ø8	ø10	ø16	ø22	
Flow rate characteristics	Kv	0.3	1.1	1.6	4.2	6.8 (8.1) ^{Note 1)}
	Cv	0.35	1.3	1.9	5	8 (9.5) ^{Note 1)}
Withstand pressure (MPa)	1					
Operating pressure <A→B flow>	Standard	-98 kPa to 0.5 MPa ^{Note 3)}		-98 kPa to 0.4 MPa ^{Note 3)}		
	High temperature	-98 kPa to 0.3 MPa ^{Note 3)}				
Back pressure (MPa)	Standard	0.3 or less		0.2 or less		
	High back pressure	0.42 or less				
	High temperature	0.3 or less		0.2 or less		
Valve leakage (cm ³ /min)	0 (With water pressure)					
Pilot air pressure (MPa)	0.3 to 0.5 (High back pressure: 0.45 to 0.55)					
Pilot port size ^{Note 2)}	1/8" (ø3), ø4, Rc 1/8, NPT 1/8					
Fluid temperature (°C)	Standard	0 to 100				
	High temperature	0 to 170				
Ambient temperature (°C)	0 to 60					
Weight (kg)	0.085	0.175	0.223	0.725	0.835	

Note 1) (): High flow type

Note 2) Refer to page 846 for details of the applicable tubing sizes.

Note 3) This product cannot be used for vacuum retention. Also, connecting the vacuum to the B port may reduce the life of the product.

⚠ Specific Product Precautions

Be sure to read this before handling the products. Refer to back page 50 for Safety Instructions and pages 845 and 846 for Air Operated Chemical Liquid Valve Precautions.

Piping

⚠ Caution

1. Tighten the nut until it touches the end surface of the body, and then tighten it an additional 1/8 turn. If the nut won't turn any further, then it means a sufficient tightening has occurred. Refer to the proper tightening torques shown below.

Tightening Torque for Piping

Body class	Torque (N·m)
2	1.6 to 1.8
3	3.2 to 3.5
4	5.0 to 5.3
5	10.0 to 10.5
6	22.5 to 23.0

LVQ

LVV

LVH

LVD

LVQ

LVP

LVW

LQ1

LQ3

LVN

LQHB

TL

TIL

TLM

TILM

TD

TID

TH

TIH

LVQS-Z Series

Construction

Basic

N.C.

N.O.

Double acting

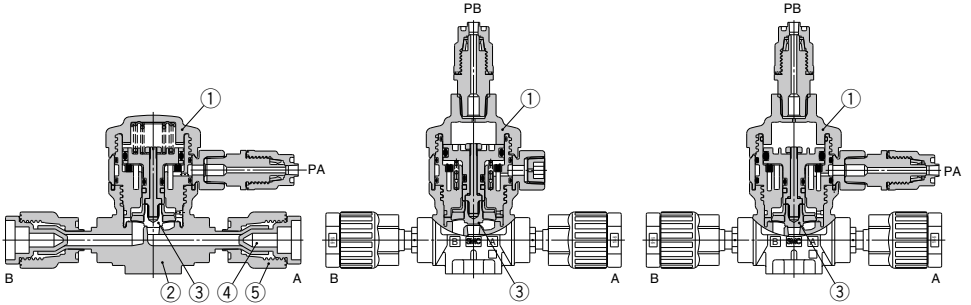

With flow rate adjustment

With by-pass

With indicator

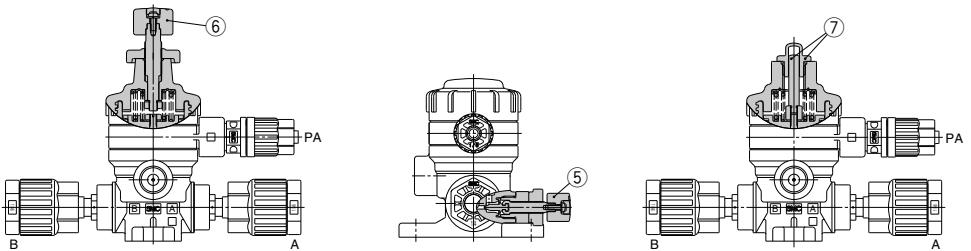

Component Parts

No.	Description	Material
1	Actuator	PVDF
2	Body	PFA
3	Diaphragm	PTFE
4	Plug	PP
5	Nut	PFA
6	Flow rate adjuster	PVDF
7	Indicator/Cover	PP

Dimensions

Basic, High back pressure

N.C. valve

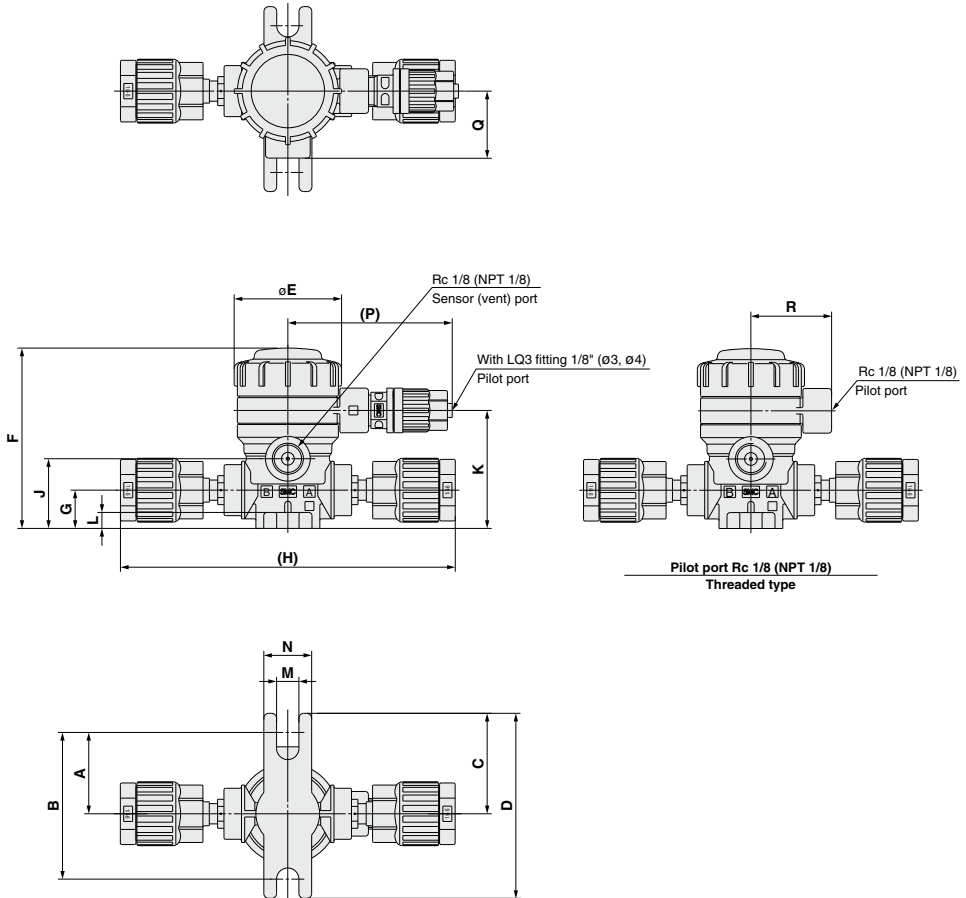

LVC
LVA
LVH
LVD
LVQ
LVP
LVW
LQ1
LQ3
LVN
LQHB
TL
TIL
TLM
TILM
TD
TID
TH
TIH

LVQ□0S-Z□ Dimensions (N.C. Valve)

(mm)

Model	A	B	C	D	E	F	G	H	J	K	L	M	N	P	Q	R
LVQ20S-Z□	25.5	46	31.5	58	33.6	56.5	12	105	21.8	37	5	7	15	53.5	21	25.3
LVQ30S-Z□	28.5	57	34.5	69	45.4	77	16.5	137	32	50	6	7	20	59.5	25	31.2
LVQ40S-Z□	28.5	57	34.5	69	45.4	82.5	22	151	37.5	55.5	6	7	20	59.5	25	31.2
LVQ50S-Z□	42	84	48	96	75	127	25	202	50.2	78.2	10	7	20	73	38.5	45
LVQ60S-Z□	42	84	48	96	75	136.8	32	236	60	88	10	7	20	73	38.5	45

LVQS-Z Series

Dimensions

With flow rate adjustment, High back pressure with flow rate adjustment

N.C. valve

Dimensions (mm)	
Model	S
LVQ20S-Z□-1	83
LVQ30S-Z□-1	113.5
LVQ40S-Z□-1	119
LVQ50S-Z□-1	171.5
LVQ60S-Z□-1	182.5

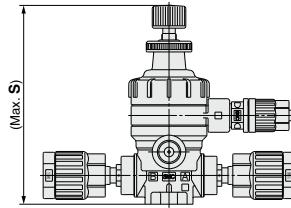

With by-pass, High back pressure with by-pass

N.C. valve

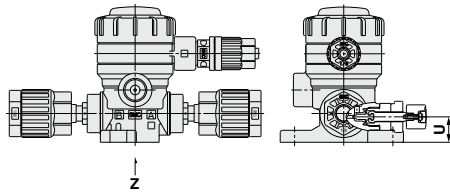
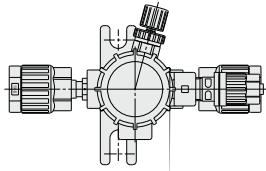

LVQ20S

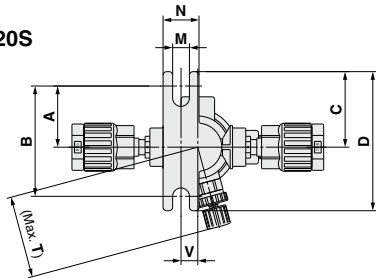

LVQ30S, LVQ40S
LVQ50S, LVQ60S

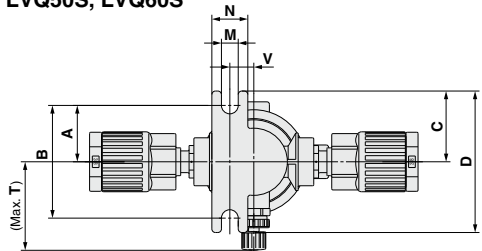

View Z

Dimensions (mm)									
Model	A	B	C	D	M	N	T	U	V
LVQ20S-Z□-2	25.5	46	31.5	58	7	15	34.3	10.6	7
LVQ30S-Z□-2	25.5	51	31.5	63	7	15	36.9	16.5	10
LVQ40S-Z□-2	25.5	51	31.5	63	7	15	37.9	22	10
LVQ50S-Z□-2	38	76	44	88	7	20	64	25	17
LVQ60S-Z□-2	38	76	44	88	7	20	66	32	17

With flow rate adjustment & by-pass,
High back pressure with flow rate adjustment & by-pass
N.C. valve

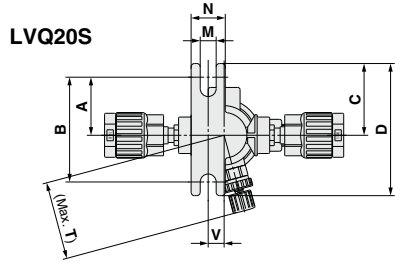
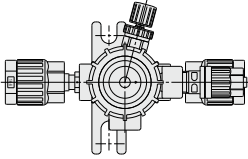

LVQ30S, LVQ40S
LVQ50S, LVQ60S

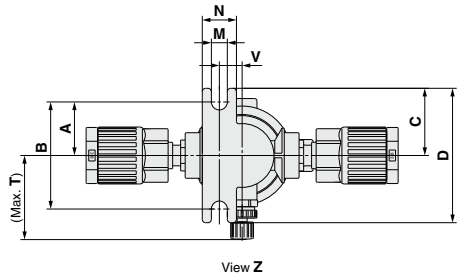
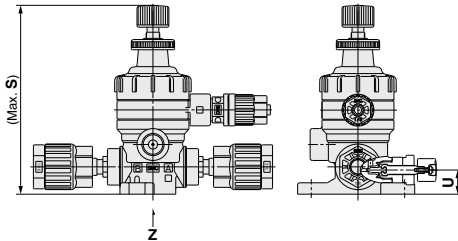

LVQ
LVA
LVH
LVD
LVQ
LVP
LVW
LQ1
LQ3
LVN
LQHB
TL
TIL
TLM
TILM
TD
TID
TH
TIH

Dimensions (mm)

Model	A	B	C	D	M	N	S	T	U	V
LVQ20S-Z□-3	25.5	46	31.5	58	7	15	83	34.3	10.6	7
LVQ30S-Z□-3	25.5	51	31.5	63	7	15	113.5	36.9	16.5	10
LVQ40S-Z□-3	25.5	51	31.5	63	7	15	119	37.9	22	10
LVQ50S-Z□-3	38	76	44	88	7	20	171.5	64	25	17
LVQ60S-Z□-3	38	76	44	88	7	20	182.5	66	32	17

With indicator, High back pressure with indicator
N.C. valve

Dimensions (mm)

Model	S
LVQ20S-Z□-4	70.5
LVQ30S-Z□-4	88.5
LVQ40S-Z□-4	94
LVQ50S-Z□-4	134.5
LVQ60S-Z□-4	144

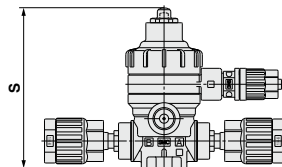

LVQS-Z Series

Dimensions

Basic N.O. valve

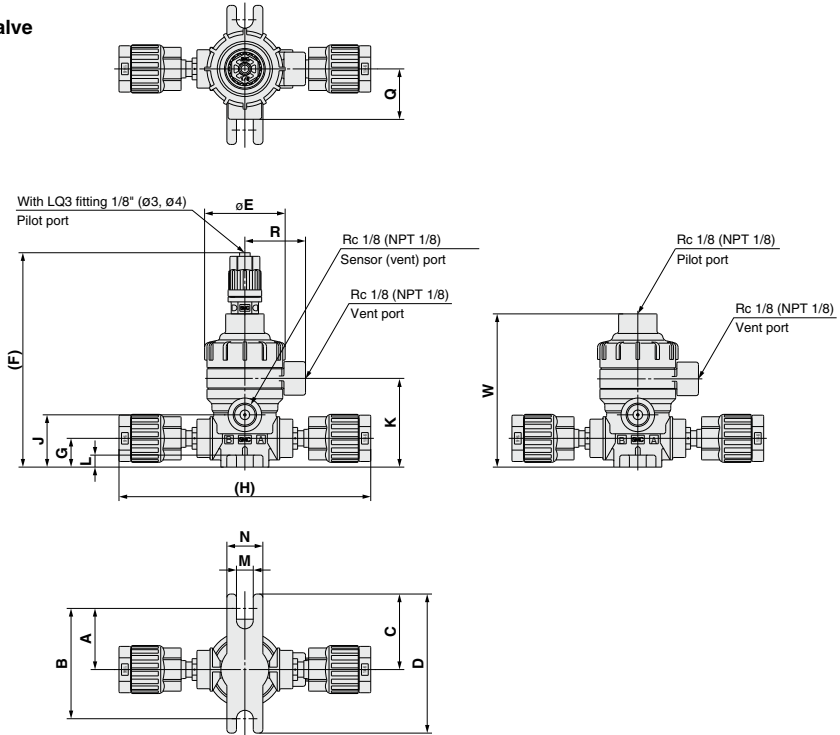

Double acting valve

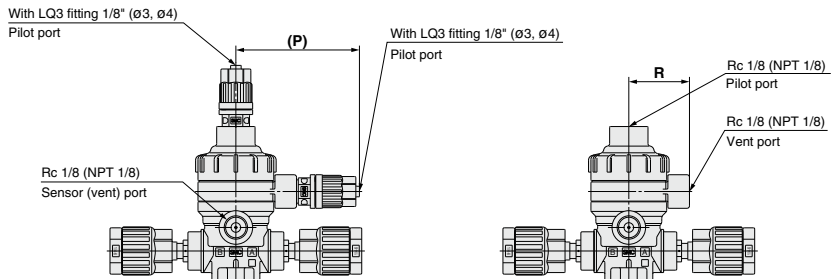

LVQ□S-Z□ Dimensions (N.O. Valve, Double Acting Valve)

Model	A	B	C	D	E	F	G	H	J	K	L	M	N	P	Q	R	W
LVQ2:S-Z□	25.5	46	31.5	58	33.6	89.5	12	105	21.8	37	5	7	15	53.5	21	25.3	64
LVQ3:S-Z□	28.5	57	34.5	69	45.4	107.5	16.5	137	32	50	6	7	20	59.5	25	31.2	82
LVQ4:S-Z□	28.5	57	34.5	69	45.4	113	22	151	37.5	55.5	6	7	20	59.5	25	31.2	87.5
LVQ5:S-Z□	42	84	48	96	75	153.2	25	202	50.2	78.2	10	7	20	73	38.5	45	128
LVQ6:S-Z□	42	84	48	96	75	163	32	236	60	88	10	7	20	73	38.5	45	137.5

With by-pass
Double acting valve

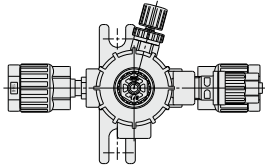

LVQ2¹/₂S

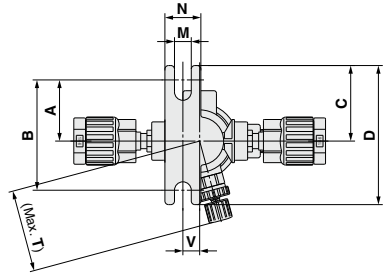

LVQ3¹/₂S, LVQ4¹/₂S
LVQ5¹/₂S, LVQ6¹/₂S

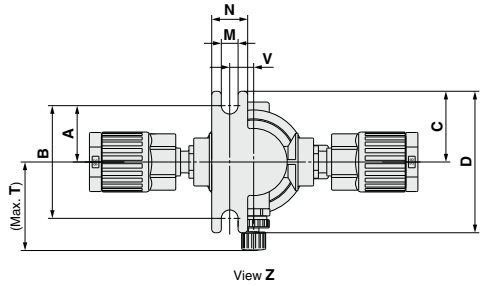
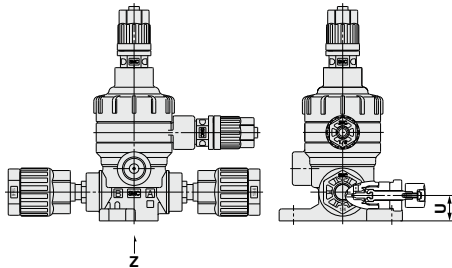

Dimensions (N.O Valve, Double Acting Valve) (mm)

Model	A	B	C	D	M	N	T	U	V
LVQ2:-S-Z□-2	25.5	46	31.5	58	7	15	34.3	10.6	7
LVQ3:-S-Z□-2	25.5	51	31.5	63	7	15	36.9	16.5	10
LVQ4:-S-Z□-2	25.5	51	31.5	63	7	15	37.9	22	10
LVQ5:-S-Z□-2	38	76	44	88	7	20	64	25	17
LVQ6:-S-Z□-2	38	76	44	88	7	20	66	32	17

- LVQ
- LVA
- LVH
- LVQ
- LVP
- LVW
- LQ1
- LQ3
- LVN
- LQHB
- TL
- TIL
- TLM
- TILM
- TD
- TID
- TH
- TIH

Manually Operated Flare, Integrated Fitting Type Hyper Fitting **LVQH-Z Series**



How to Order

LVQH **2** 0 - Z **07** - **1** -

Body class

Symbol	Body class	Orifice dia.
2	2	ø4
3	3	ø8
4	4	ø10
5	5	ø16
6	6	ø22

Option

Symbol	Option
Nil	None
K	Buffer material FFKM
N	For ammonium hydroxide

Note) Options cannot be combined each other.

LQ3 integrated fitting

Applicable tubing size

Symbol	Connection tubing O.D.	Body class					
		2	3	4	5	6	
Metric size							
03	ø3	○					
04	ø4	○					
06	ø6	○					
08	ø8		○				
10	ø10		○				
12	ø12			○			
19	ø19				○		
25	ø25					○	
Inch size							
03	1/8	○					
07	1/4	○					
11	3/8		○				
13	1/2			○			
19	3/4				○		
25	1					○	

Handle operation

1	90° turn type
4	Multi-turn type (With indicator)

Vent port type

Nil	Threaded	NPT 1/8
R	Threaded	Rc1/8

Variations

Type	Symbol	Model				
		Orifice diameter				
		LVQH20	LVQH30	LVQH40	LVQH50	LVQH60
		Tubing O.D.				
		Metric				
		Inch				
		1/4	3/8	1/2	3/4	1
90° turn type		○	○	○	○	○
Multi-turn type		○	○	○	○	○

Standard Specifications



Model		LVQH20	LVQH30	LVQH40	LVQH50	LVQH60
Tubing O.D.	Metric	6	10	12	19	25
	Inch	1/4	3/8	1/2	3/4	1
Orifice diameter		ø4	ø8	ø10	ø16	ø22
Flow rate characteristics	Kv	0.3	1.1	1.6	4.2	6.8
	Cv	0.35	1.3	1.9	5	8
Withstand pressure (MPa)		1				
Fluid pressure <A→B>		-98 kPa to 0.5 MPa <small>Note)</small>			-98 kPa to 0.4 MPa <small>Note)</small>	
Back pressure (MPa)		0.3 or less			0.2 or less	
Valve leakage (cm ³ /min)		0 (With water pressure)				
Fluid temperature (°C)		0 to 100				
Ambient temperature (°C)		0 to 60				
Weight (kg)	LVQH□0-1	0.12	0.27	0.32	1.14	1.20
	LVQH□0-4	0.11	0.25	0.23	0.72	0.82

Note) This product cannot be used for vacuum retention. Also, connecting the vacuum to the B port may reduce the life of the product.

⚠ Specific Product Precautions

Be sure to read this before handling the products. Refer to back page 50 for Safety Instructions and pages 845 and 846 for Air Operated Chemical Liquid Valve Precautions.

Piping

⚠ Caution

1. Connect tubing by special tools.

For information on tubing fittings and special tools, please see the pamphlet "High Purity Fluoropolymer Fittings Hyper Fitting Flare Type LQ3 Series Fitting Procedure" (M-E06-4). (The pamphlet can be downloaded from the SMC home page.)

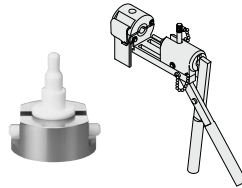

2. Tighten the nut until it touches the end surface of the body, and then tighten it an additional 1/8 turn. If the nut won't turn any further, then it means a sufficient tightening has occurred. Refer to the proper tightening torques shown below.

Tightening Torque for Piping

Body class	Torque (N·m)
2	1.6 to 1.8
3	3.2 to 3.5
4	5.0 to 5.3
5	10.0 to 10.5
6	22.5 to 23.0

LVQH-Z Series

Construction

90° turn type

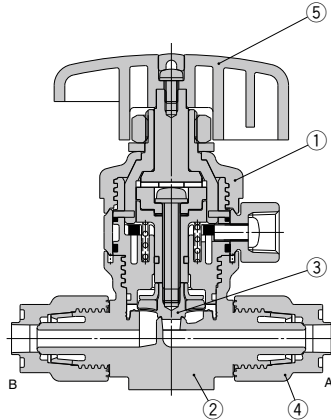

Multi-turn type (With indicator)

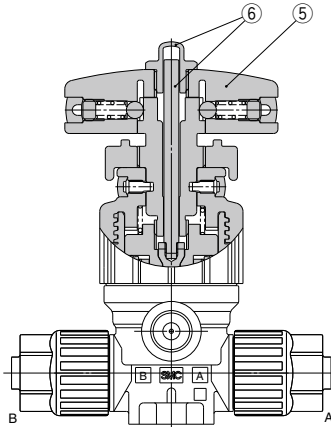

Component Parts

No.	Description	Material
1	Actuator	PVDF
2	Body	PFA
3	Diaphragm	PTFE
4	Nut	PFA
5	Handle	PVDF
6	Indicator/Cover	PP

Dimensions

90° turn type

Dimensions

Model	A	B	C	D	F	G	H
LVQH20-Z□□-1	25.5	46	31.5	58	79	12	75
LVQH30-Z□□-1	28.5	57	34.5	69	103	16.5	103
LVQH40-Z□□-1	28.5	57	34.5	69	108	22	114
LVQH50-Z□□-1	42	84	48	96	165	25	150
LVQH60-Z□□-1	42	84	48	96	175	32	167

Model	J	K	L	M	N	Q	Y
LVQH20-Z□□-1	21.8	37	5	7	15	21	55
LVQH30-Z□□-1	32	50	6	7	20	25	80
LVQH40-Z□□-1	37.5	55.5	6	7	20	25	80
LVQH50-Z□□-1	50.2	78.2	10	7	20	38.5	110
LVQH60-Z□□-1	60	88	10	7	20	38.5	110

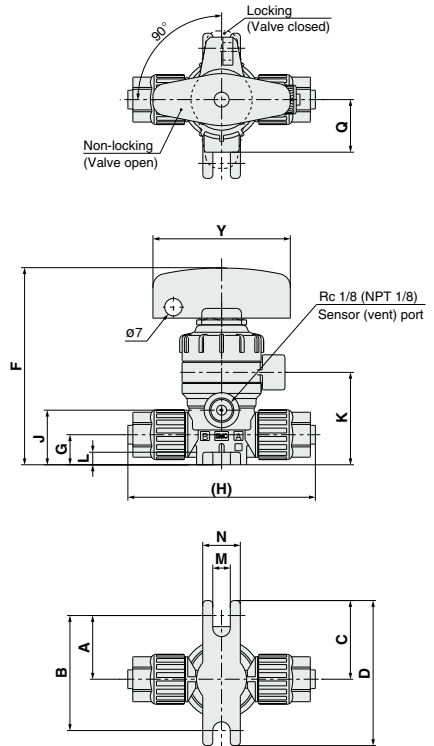

LVC
LVA
LVH
LVD
LVQ
LVP
LVW
LQ1
LQ3
LVN
LQHB
TL
TIL
TLM
TILM
TD
TID
TH
TIH

Multi-turn type (With indicator)

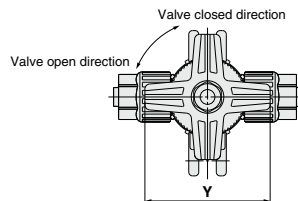

Dimensions

Model	S	Y
LVQH20-Z□-4	93.6	50
LVQH30-Z□-4	111.2	50
LVQH40-Z□-4	116.7	50
LVQH50-Z□-4	170.7	71
LVQH60-Z□-4	180.2	71

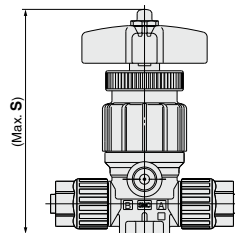

Manually Operated Flare, Integrated Fitting Type Space Saving/Space Saving Connection **LVQHS-Z Series** RoHS

How to Order

LVQH 2 0 S - Z 07 - 1 -

Body class

Symbol	Body class	Orifice dia.
2	2	ø4
3	3	ø8
4	4	ø10
5	5	ø16
6	6	ø22

Body type

S	Space saving connection
---	-------------------------

LQ3 integrated fitting

Option

Symbol	Option
Nil	None
K	Buffer material FFKM
N	For ammonium hydroxide

Note) Options cannot be combined each other.

Handle operation

1	90° turn type
4	Multi-turn type (With indicator)

Vent port type

Nil	Threaded	NPT 1/8
R	Threaded	Rc 1/8

Applicable fitting size

Symbol	Fitting size	Body class				
		2	3	4	5	6
Inch size						
07	2	○				
11	3		○			
13	4			○		
19	5				○	
25	6					○

Note) Refer to page 827 for How to Order applicable fittings.
Select the same size as fitting on the valve.

Variations

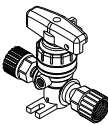
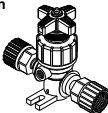
Model	LVQ20S	LVQ30S	LVQ40S	LVQ50S	LVQ60S	
						Orifice diameter
Type	Symbol	2	3	4	5	6
90° turn type		○	○	○	○	○
Multi-turn type		○	○	○	○	○

How to Order Space Saving Fittings

LQ3 E 6A - SN -

• **Packaging**

Symbol	Packaging
Nil	Clean packaging equivalent to Class M3.5
1	Standard packaging equivalent to Class M5.5

• **One of the nuts is not attached.**

• **Fitting type**

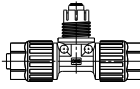
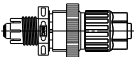
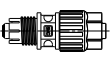
E	T
Union elbow 	Union tee 
P	U
Panel mount union 	Union 

• **Applicable tubing size** Note 1) Note 2)

Size	Symbol	Applicable tubing size (mm)
2	1	6 x 4
3	1	10 x 8
3	2	8 x 6
4	1	12 x 10
5	1	19 x 16
6	1	25 x 22

Size	Symbol	Applicable tubing size (inch)
2	A	1/4" x 5/32"
3	A	3/8" x 1/4"
4	A	1/2" x 3/8"
5	A	3/4" x 5/8"
6	A	1" x 7/8"

Note 1) Select the same size as the fitting on the valve.

Note 2) Refer to page 846 for details of the applicable tubing sizes.

Piping Example

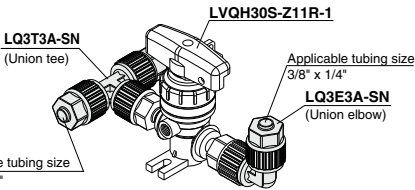

LVQH30S-Z11R-1

LQ3T3A-SN
(Union tee)

LQ3E3A-SN
(Union elbow)

Applicable tubing size
3/8" x 1/4"

Applicable tubing size
3/8" x 1/4"

Ordering Example

LVQH30S-Z11R-1 1

LQ3T3A-SN (Union tee) 1

LQ3E3A-SN (Union elbow) 1

Note) For shipment, the valve and fittings are individually packaged and dispatched together in 1 box.

- LVC**
- LVA**
- LVH**
- LVD**
- LVQ**
- LVP**
- LVW**
- LQ1**
- LQ3**
- LVN**
- LQHB**
- TL**
- TIL**
- TLM**
- TILM**
- TD**
- TID**
- TH**
- TIH**



Standard Specifications

Model	LVQH20S	LVQH30S	LVQH40S	LVQH50S	LVQH60S	
Connection fitting size	2	3	4	5	6	
Orifice diameter	ø4	ø8	ø10	ø16	ø22	
Flow rate characteristics	Kv	0.3	1.1	1.6	4.2	6.8
	Cv	0.35	1.3	1.9	5	8
Withstand pressure (MPa)	1					
Fluid pressure <A→B>	-98 kPa to 0.5 MPa ^{Note)}			-98 kPa to 0.4 MPa ^{Note)}		
Back pressure (MPa)	0.3 or less			0.2 or less		
Valve leakage (cm ³ /min)	0 (With water pressure)					
Fluid temperature (°C)	0 to 100					
Ambient temperature (°C)	0 to 60					
Weight (kg)	LVQH□0S-1	0.14	0.28	0.34	1.14	1.15
	LVQH□0S-4	0.13	0.21	0.25	0.72	0.86

Note) This product cannot be used for vacuum retention. Also, connecting the vacuum to the B port may reduce the life of the product.

⚠ Specific Product Precautions

Be sure to read this before handling the products. Refer to back page 50 for Safety Instructions and pages 845 and 846 for Air Operated Chemical Liquid Valve Precautions.

Piping

⚠ Caution

1. Tighten the nut until it touches the end surface of the body, and then tighten it an additional 1/8 turn. If the nut won't turn any further, then it means a sufficient tightening has occurred. Refer to the proper tightening torques shown below.

Tightening Torque for Piping

Body class	Torque (N·m)
2	1.6 to 1.8
3	3.2 to 3.5
4	5.0 to 5.3
5	10.0 to 10.5
6	22.5 to 23.0

Construction

90° turn type

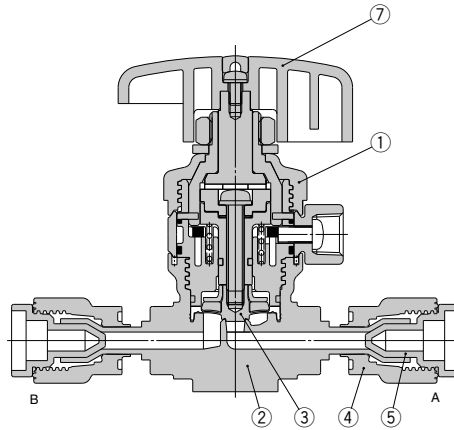

Multi-turn type (With indicator)

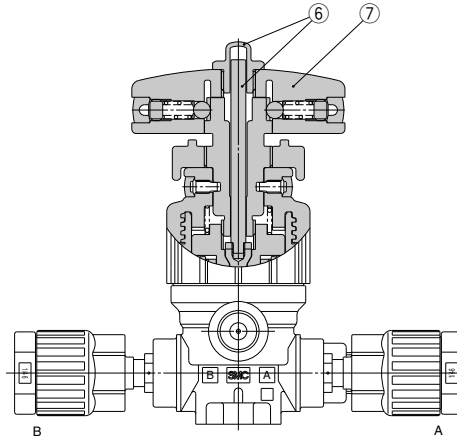

Component Parts

No.	Description	Material
1	Actuator	PVDF
2	Body	PFA
3	Diaphragm	PTFE
4	Nut	PFA
5	Plug	PP
6	Indicator/Cover	PP
7	Handle	PVDF

LVC
LVA
LVH
LVD
LVQ
LVP
LVW
LQ1
LQ3
LVN
LQHB
TL
TIL
TLM
TILM
TD
TID
TH
TIH

LVQHS-Z Series

Dimensions

90° turn type

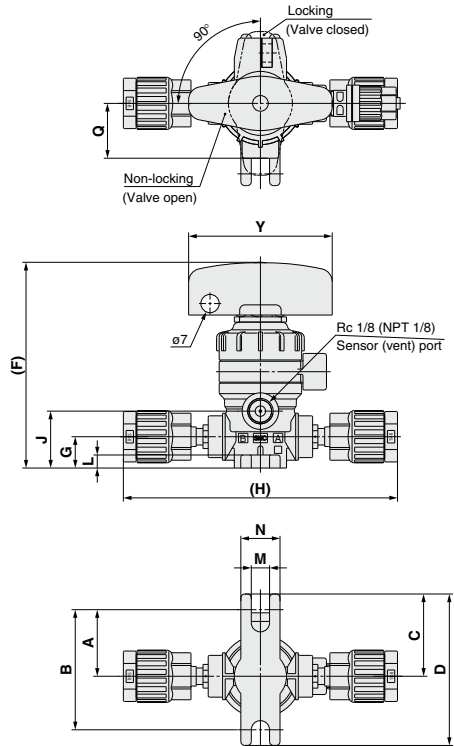

Dimensions

Model	A	B	C	D	F	G	H
LVQH20S-Z□-1	25.5	46	31.5	58	79	12	105
LVQH30S-Z□-1	28.5	57	34.5	69	103	16.5	137
LVQH40S-Z□-1	28.5	57	34.5	69	108	22	151
LVQH50S-Z□-1	42	84	48	96	165	25	202
LVQH60S-Z□-1	42	84	48	96	175	32	236

Model	J	K	L	M	N	Q	Y
LVQH20S-Z□-1	21.8	37	5	7	15	21	55
LVQH30S-Z□-1	32	50	6	7	20	25	80
LVQH40S-Z□-1	37.5	55.5	6	7	20	25	80
LVQH50S-Z□-1	50.2	78.2	10	7	20	38.5	110
LVQH60S-Z□-1	60	88	10	7	20	38.5	110

Multi-turn type (With indicator)

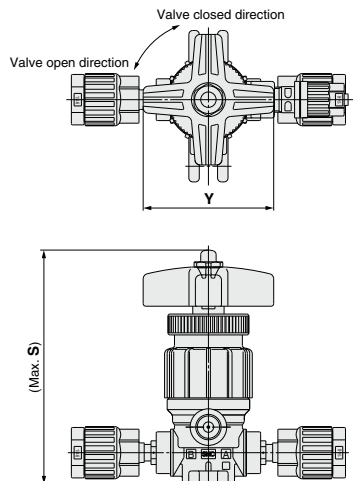

Dimensions

Model	S	Y
LVQH20S-Z□-4	93.6	50
LVQH30S-Z□-4	111.2	50
LVQH40S-Z□-4	116.7	50
LVQH50S-Z□-4	170.7	71
LVQH60S-Z□-4	180.2	71

Air Operated Tube Extension Type **LVQ-T Series**



How to Order

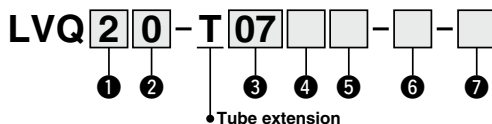

1 Body class

Symbol	Body class	Orifice dia.
2	2	ø4
3	3	ø8
4	4	ø10
5	5	ø16
6	6	ø22

4 Pilot port type

Symbol	Fitting	Connection tubing O.D.
Nil	With LQ1 fitting	Connection tubing O.D. 1/8" (ø3)
M	With LQ1 fitting	Connection tubing O.D. ø4
R	Threaded	Rc1/8
N	Threaded	NPT1/8

2 Valve type

0	N.C.
1	N.O.
2	Double acting

Note) For valve type combinations, refer to variations on the next page.

5 Pilot port direction

Symbol	Direction
Nil	1
P2	2
P3	3
P4	4
P5	5
P6	6
P7	7
P8	8

Pilot port piping direction

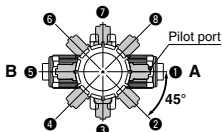

* Specify the piping direction by part number when ordering the product. Do not change the pilot port direction. (Refer to Precautions on page 846.)

3 Applicable tubing size

Symbol	Connection tubing O.D.	Body class					
		2	3	4	5	6	
Metric size							
06	ø6	<input type="checkbox"/>	<input type="checkbox"/>	<input type="checkbox"/>	<input type="checkbox"/>	<input type="checkbox"/>	<input type="checkbox"/>
10	ø10	<input type="checkbox"/>	<input type="checkbox"/>	<input type="checkbox"/>	<input type="checkbox"/>	<input type="checkbox"/>	<input type="checkbox"/>
12	ø12	<input type="checkbox"/>	<input type="checkbox"/>	<input type="checkbox"/>	<input type="checkbox"/>	<input type="checkbox"/>	<input type="checkbox"/>
19	ø19	<input type="checkbox"/>	<input type="checkbox"/>	<input type="checkbox"/>	<input type="checkbox"/>	<input type="checkbox"/>	<input type="checkbox"/>
25	ø25	<input type="checkbox"/>	<input type="checkbox"/>	<input type="checkbox"/>	<input type="checkbox"/>	<input type="checkbox"/>	<input type="checkbox"/>
Inch size							
07	1/4	<input type="checkbox"/>	<input type="checkbox"/>	<input type="checkbox"/>	<input type="checkbox"/>	<input type="checkbox"/>	<input type="checkbox"/>
11	3/8	<input type="checkbox"/>	<input type="checkbox"/>	<input type="checkbox"/>	<input type="checkbox"/>	<input type="checkbox"/>	<input type="checkbox"/>
13	1/2	<input type="checkbox"/>	<input type="checkbox"/>	<input type="checkbox"/>	<input type="checkbox"/>	<input type="checkbox"/>	<input type="checkbox"/>
19	3/4	<input type="checkbox"/>	<input type="checkbox"/>	<input type="checkbox"/>	<input type="checkbox"/>	<input type="checkbox"/>	<input type="checkbox"/>
25	1	<input type="checkbox"/>	<input type="checkbox"/>	<input type="checkbox"/>	<input type="checkbox"/>	<input type="checkbox"/>	<input type="checkbox"/>

6 Option 1

Nii	None
1	With flow rate adjustment
2	With by-pass
3	With flow rate adjustment & by-pass
4	With indicator
5	High back pressure (0.42 MPa)
6	High back pressure with flow rate adjustment
7	High back pressure with by-pass
8	High back pressure with flow rate adjustment & by-pass
9	High back pressure with indicator









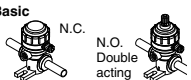

Note) Refer to variations in the table below for valve type and option 1 combinations. Options in the same table can not be combined each other.

7 Option 2

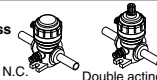
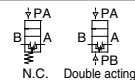
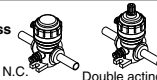
Symbol	Applicable option									Note
	1	2	3	4	5	6	7	8	9	
Nii	○	○	○	○	○	○	○	○	○	—
J	○	—	—	—	—	—	—	—	—	For high temperature
K	○	○	○	○	○	○	○	○	○	Buffer material FFKM
N	○	○	○	○	○	○	○	○	○	For ammonium hydroxide
P	—	—	—	○	○	—	—	—	—	High flow type LVQ6□ only

Note 1) Options 2 in the same table cannot be combined each other.
Note 2) High back pressure specifications (5 to 9) in Option 1 and high temperature specification (J) in Option 2 cannot be combined.

Variations

Type	Symbol	Model	Orifice diameter				
			LVQ20	LVQ30	LVQ40	LVQ50	LVQ60
			Tubing O.D.				
			Valve type				
Basic  N.C. N.O. Double acting	 N.C. N.O. Double acting	N.C.	○	○	○	○	
		N.O.	○	○	○	○	
With flow rate adjustment  N.C.	 N.C.	N.C.	○	○	○	○	
		Double acting	○	○	○	○	
With by-pass  N.C. Double acting	 N.C. Double acting	N.C.	○	○	○	○	
		Double acting	○	○	○	○	
With flow rate adjustment & by-pass  N.C.	 N.C.	N.C.	○	○	○	○	
With indicator  N.C.	 N.C.	N.C.	○	○	○	○	
High back pressure  N.C.	 N.C.	N.C.	○	○	○	○	

- LVQ
- LVA
- LVH
- LVQ
- LVP
- LVW
- LQ1
- LQ3
- LVN
- LQHB
- TL
- TIL
- TLM
- TILM
- TD
- TID
- TH
- TIH

LVQ-T Series



Standard Specifications

Model		LVQ20	LVQ30	LVQ40	LVQ50	LVQ60
Tubing O.D.	Metric	6	10	12	19	25
	Inch	1/4	3/8	1/2	3/4	1
Orifice diameter		ø4	ø8	ø10	ø16	ø22
Flow rate characteristics	Kv	0.3	1.1	1.6	4.2	6.8 (8.1) ^{Note 1)}
	Cv	0.35	1.3	1.9	5	8 (9.5) ^{Note 1)}
Withstand pressure (MPa)		1				
Operating pressure <A→B flow>	Standard	-98 kPa to 0.5 MPa ^{Note 2)}			-98 kPa to 0.4 MPa ^{Note 2)}	
	High temperature	-98 kPa to 0.3 MPa ^{Note 2)}				
Back pressure (MPa)	Standard	0.3 or less			0.2 or less	
	High back pressure	0.42 or less				
	High temperature	0.3 or less			0.2 or less	
Valve leakage (cm ³ /min)		0 (With water pressure)				
Pilot air pressure (MPa)		0.3 to 0.5 (High back pressure: 0.45 to 0.55)				
Pilot port size		1/8" (ø3), ø4, Rc 1/8, NPT 1/8				
Fluid temperature (°C)	Standard	0 to 100				
	High temperature	0 to 170				
Ambient temperature (°C)		0 to 60				
Weight (kg)		0.08	0.15	0.16	0.60	0.70

Note 1) () : High flow type

Note 2) This product cannot be used for vacuum retention. Also, connecting the vacuum to the B port may reduce the life of the product.

Construction

Basic
N.C.

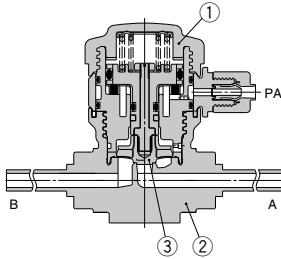

N.O.

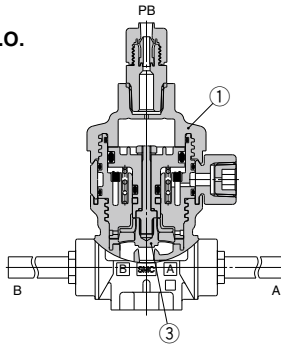

Double acting

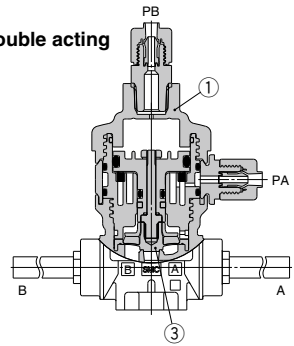

With flow rate adjustment

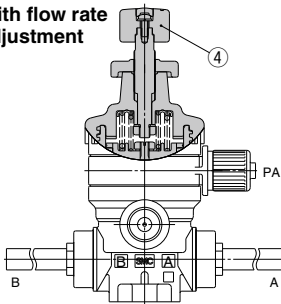

With by-pass

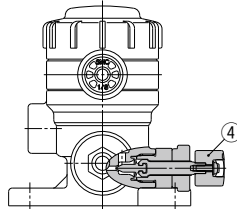

With indicator

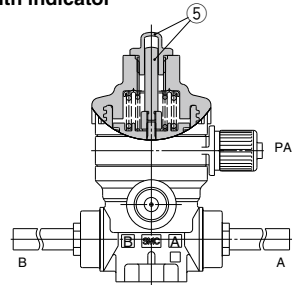

Component Parts

No.	Description	Material
1	Actuator	PVDF
2	Body	PFA
3	Diaphragm	PTFE
4	Flow rate adjuster	PVDF
5	Indicator/Cover	PP

Dimensions

Basic, High back pressure
N.C. valve

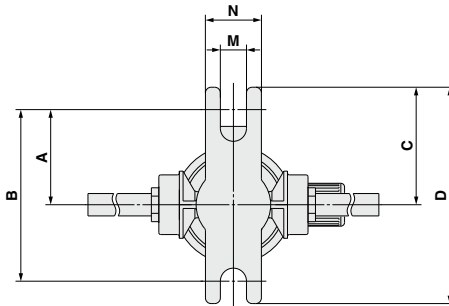
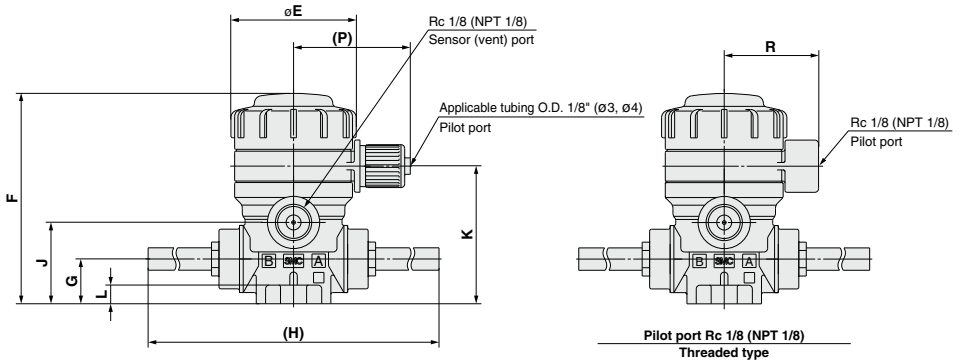
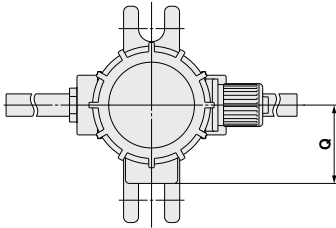

LVC
LVA
LVH
LVD
LVQ
LVP
LVW
LQ1
LQ3
LVN
LQHB
TL
TIL
TLM
TILM
TD
TID
TH
TIH

LVQ□0-T□ Dimensions (N.C. Valve)

(mm)

Model	A	B	C	D	E	F	G	H	J	K	L	M	N	P	Q	R
LVQ20-T□	25.5	46	31.5	58	33.6	56.5	12	111.5	21.8	37	5	7	15	31.3	21	25.3
LVQ30-T□	28.5	57	34.5	69	45.4	77	16.5	136	32	50	6	7	20	37.2	25	31.2
LVQ40-T□	28.5	57	34.5	69	45.4	82.5	22	137	37.5	55.5	6	7	20	37.2	25	31.2
LVQ50-T□	42	84	48	96	75	127	25	180	50.2	78.2	10	7	20	50.8	38.5	45
LVQ60-T□	42	84	48	96	75	137	32	189	60	88	10	7	20	50.8	38.5	45

LVQ-T Series

Dimensions

With flow rate adjustment, High back pressure with flow rate adjustment

N.C. valve

Dimensions (mm)

Model	S
LVQ20-T□-1	83
LVQ30-T□-1	113.5
LVQ40-T□-1	119
LVQ50-T□-1	171.5
LVQ60-T□-1	182.5

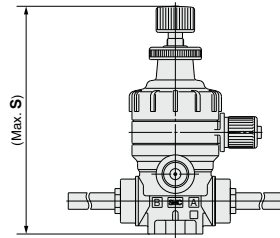

With by-pass, High back pressure with by-pass

N.C. valve

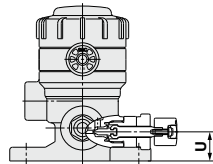
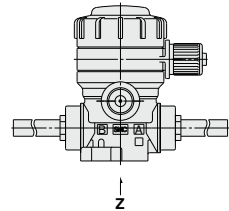
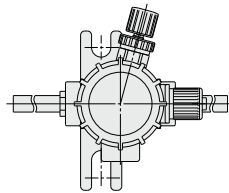

LVQ20

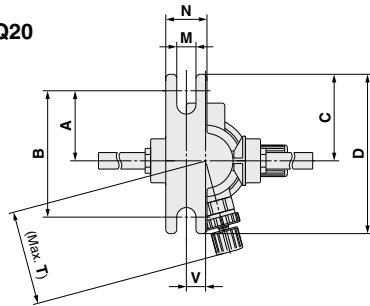

LVQ30, LVQ40
LVQ50, LVQ60

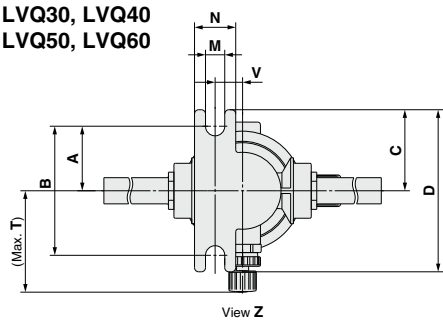

Dimensions

(mm)

Model	A	B	C	D	M	N	T	U	V
LVQ20-T□-2	25.5	46	31.5	58	7	15	34.3	10.6	7
LVQ30-T□-2	25.5	51	31.5	63	7	15	36.9	16.5	10
LVQ40-T□-2	25.5	51	31.5	63	7	15	37.9	22	10
LVQ50-T□-2	38	76	44	88	7	20	64	25	17
LVQ60-T□-2	38	76	44	88	7	20	66	32	17

With flow rate adjustment & by-pass,
High back pressure with flow rate adjustment & by-pass
N.C. valve

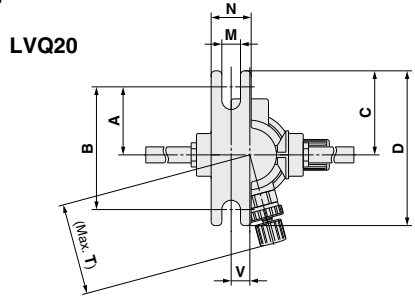
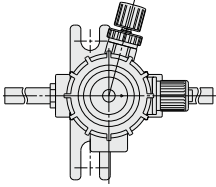

LVQ30, LVQ40
LVQ50, LVQ60

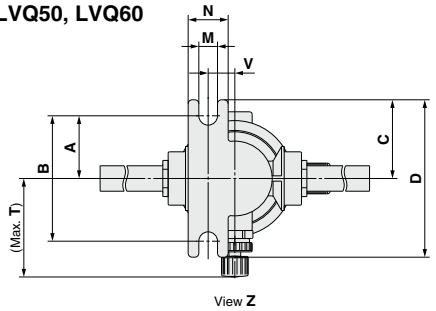
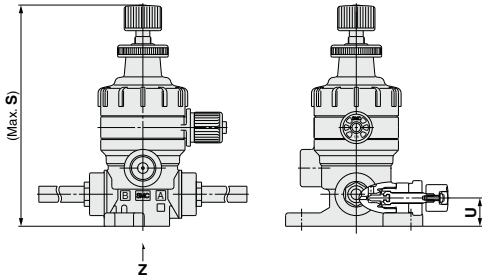

LVQ
LVA
LVH
LVD
LVQ
LVP
LVW
LQ1
LQ3
LVN
LQHB
TL
TIL
TLM
TILM
TD
TID
TH
TIH

Dimensions (mm)

Model	A	B	C	D	M	N	S	T	U	V
LVQ20-T□-3	25.5	46	31.5	58	7	15	83	34.3	10.6	7
LVQ30-T□-3	25.5	51	31.5	63	7	15	113.5	36.9	16.5	10
LVQ40-T□-3	25.5	51	31.5	63	7	15	119	37.9	22	10
LVQ50-T□-3	38	76	44	88	7	20	171.5	64	25	17
LVQ60-T□-3	38	76	44	88	7	20	182.5	66	32	17

With indicator, High back pressure with indicator
N.C. valve

Dimensions (mm)

Model	S
LVQ20-T□-4	70.5
LVQ30-T□-4	88.5
LVQ40-T□-4	94
LVQ50-T□-4	134.5
LVQ60-T□-4	144

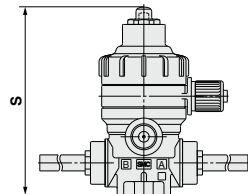

LVQ-T Series

Dimensions

Basic N.O. valve

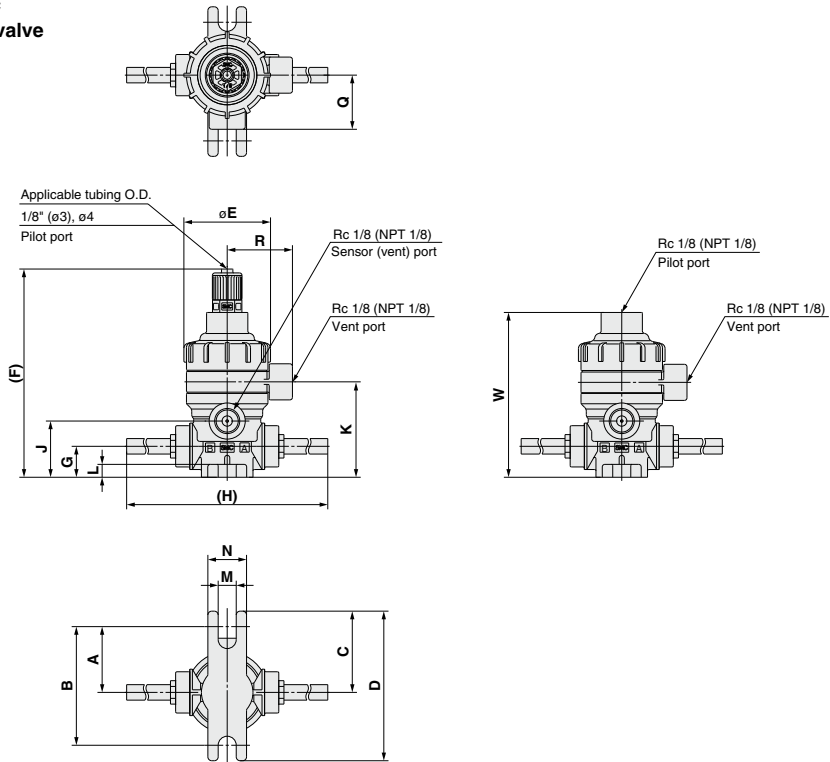

Double acting valve

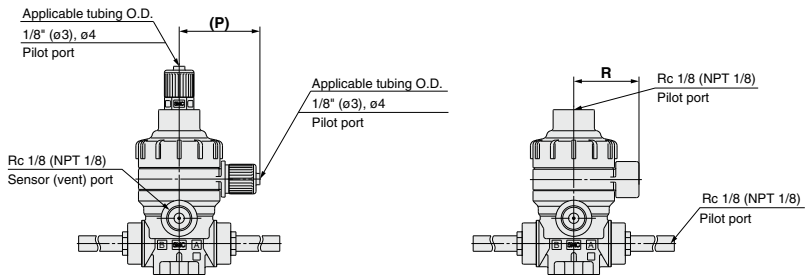

LVQ□₂-T□ Dimensions (N.O. Valve, Double Acting Valve)

(mm)

Model	A	B	C	D	E	F	G	H	J	K	L	M	N	P	Q	R	W
LVQ2 ₁ -T□	25.5	46	31.5	58	33.6	81	12	111.5	21.8	37	5	7	15	31.3	21	25.3	64
LVQ3 ₁ -T□	28.5	57	34.5	69	45.4	99	16.5	136	32	50	6	7	20	37.2	25	31.2	82
LVQ4 ₁ -T□	28.5	57	34.5	69	45.4	104	22	137	37.5	55.5	6	7	20	37.2	25	31.2	87.5
LVQ5 ₁ -T□	42	84	48	96	75	144.5	25	180	50.2	78.2	10	7	20	50.8	38.5	45	128
LVQ6 ₁ -T□	42	84	48	96	75	154.5	32	189	60	88	10	7	20	50.8	38.5	45	137.5

With by-pass
Double acting valve

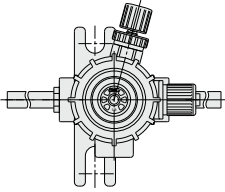

LVQ2¹₂

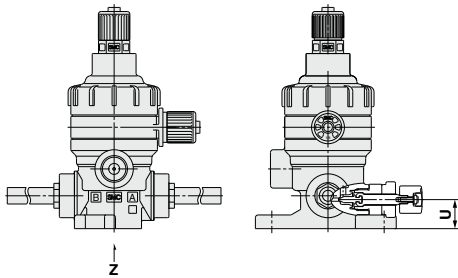
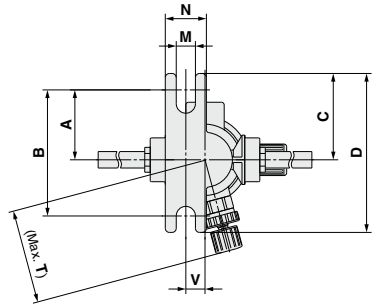

LVQ3¹₂, LVQ4¹₂
LVQ5¹₂, LVQ6¹₂

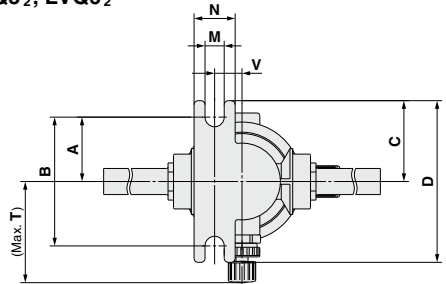

View Z

Dimensions

(mm)

Model	A	B	C	D	M	N	T	U	V
LVQ2 ¹ -T□-2	25.5	46	31.5	58	7	15	34.3	10.6	7
LVQ3 ¹ -T□-2	25.5	51	31.5	63	7	15	36.9	16.5	10
LVQ4 ¹ -T□-2	25.5	51	31.5	63	7	15	37.9	22	10
LVQ5 ¹ -T□-2	38	76	44	88	7	20	64	25	17
LVQ6 ¹ -T□-2	38	76	44	88	7	20	64	32	17

- LVC
- LVA
- LVH
- LVD
- LVQ**
- LVP
- LVW
- LQ1
- LQ3
- LVN
- LQHB
- TL
- TIL
- TLM
- TILM
- TD
- TID
- TH
- TIH

Manually Operated Tube Extension Type

LVQH-T Series

RoHS

How to Order

LVQH **2** 0 - T 07 **1** - **1** - **1**

Body class

Symbol	Body class	Orifice dia.
2	2	ø4
3	3	ø8
4	4	ø10
5	5	ø16
6	6	ø22

Tube extension

Applicable tubing size

Symbol	Connection tubing O.D.	Body class				
		2	3	4	5	6
Metric size						
06	ø6	○				
10	ø10		○			
12	ø12			○		
19	ø19				○	
25	ø25					○
Inch size						
07	1/4	○				
11	3/8		○			
13	1/2			○		
19	3/4				○	
25	1					○

Option

Symbol	Option
Nil	None
K	Buffer material FFKM
N	For ammonium hydroxide

Note) Options cannot be combined each other.

Handle operation

1	90° turn type
4	Multi-turn type (With indicator)

Vent port type

Nil	Threaded	NPT 1/8
R	Threaded	Rc 1/8

Variations

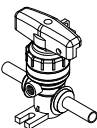
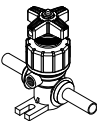
Type	Symbol	Model				
		Orifice diameter				
		LVQH20-T	LVQH30-T	LVQH40-T	LVQH50-T	LVQH60-T
		Tubing O.D.				
		Metric				
		Inch				
		1/4	3/8	1/2	3/4	1
90° turn type		○	○	○	○	○
Multi-turn type		○	○	○	○	○

Standard Specifications



Model		LVQH20	LVQH30	LVQH40	LVQH50	LVQH60
Tubing O.D.	Metric	6	10	12	19	25
	Inch	1/4	3/8	1/2	3/4	1
Orifice diameter		ø4	ø8	ø10	ø16	ø22
Flow rate characteristics	Kv	0.3	1.1	1.6	4.2	6.8
	Cv	0.35	1.3	1.9	5	8
Withstand pressure (MPa)		1				
Fluid pressure <A→B>		-98 kPa to 0.5 MPa ^{Note)}			-98 kPa to 0.4 MPa ^{Note)}	
Back pressure (MPa)		0.3 or less			0.2 or less	
Valve leakage (cm ³ /min)		0 (With water pressure)				
Fluid temperature (°C)		0 to 100				
Ambient temperature (°C)		0 to 60				
Weight (kg)	LVQH□0-1	0.12	0.25	0.28	1.04	1.05
	LVQH□0-4	0.11	0.18	0.19	0.62	0.73

Note) This product cannot be used for vacuum retention. Also, connecting the vacuum to the B port may reduce the life of the product.

Construction

90° turn type

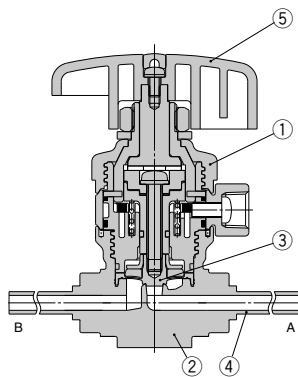

Multi-turn type (With indicator)

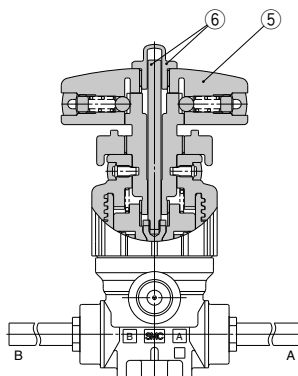

Component Parts

No.	Description	Material
1	Actuator	PVDF
2	Body	PFA
3	Diaphragm	PTFE
4	Insert bushing	PFA
5	Handle	PVDF
6	Indicator/Cover	PP

LVQ

LVA

LVH

LVQ

LVQ

LVP

LVW

LQ1

LQ3

LVN

LQHB

TL

TIL

TLM

TILM

TD

TID

TH

TIH

LVQH-T Series

Dimensions

90° turn type

Dimensions

Model	A	B	C	D	F	G	H
LVQH20-T□-1	25.5	46	31.5	58	79	12	111.5
LVQH30-T□-1	28.5	57	34.5	69	103	16.5	136
LVQH40-T□-1	28.5	57	34.5	69	108	22	137
LVQH50-T□-1	42	84	48	96	165	25	180
LVQH60-T□-1	42	84	48	96	175	32	189

Model	J	K	L	M	N	Q	Y
LVQH20-T□-1	21.8	37	5	7	15	21	55
LVQH30-T□-1	32	50	6	7	20	25	80
LVQH40-T□-1	37.5	55.5	6	7	20	25	80
LVQH50-T□-1	50.2	78.2	10	7	20	38.5	110
LVQH60-T□-1	60	88	10	7	20	38.5	110

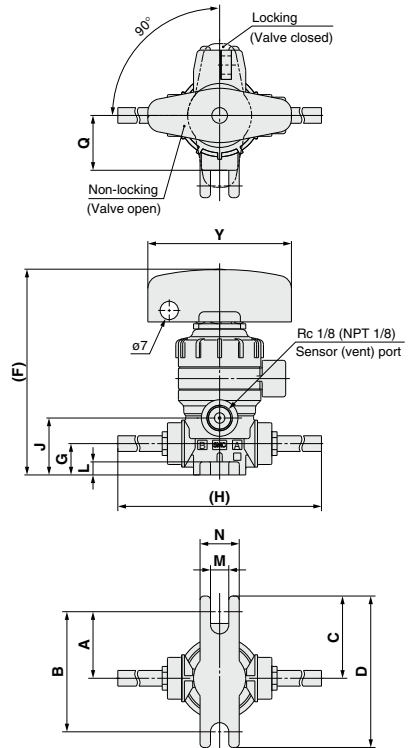

Multi-turn type (With indicator)

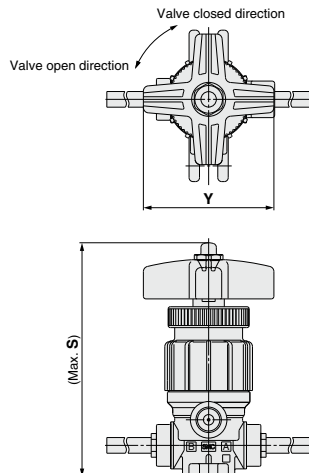

Dimensions

Model	S	Y
LVQH20-T□-4	93.6	50
LVQH30-T□-4	111.2	50
LVQH40-T□-4	116.7	50
LVQH50-T□-4	170.7	71
LVQH60-T□-4	180.2	71

Air Operated, 0.5 MPa Back Pressure Tolerant Insert Bushing, Integrated Fitting Type Hyper Fitting

LVQ□□H Series

RoHS

How to Order

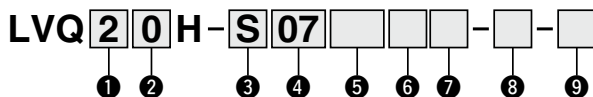

1 Body class

Symbol	Body class	Orifice dia.
2	2	ø4
3	3	ø8
4	4	ø10
5	5	ø16
6	6	ø22

2 Valve type

0	N.C.
1	N.O.
2	Double acting

Note) For valve type combinations, refer to variations on the next page.

3 Fitting type

Symbol	Fitting type	Body class
V	LQ1	2, 3, 4, 5, 6
S	LQ2	2, 3, 4, 5

Note) Insert bushing is used in common.

4 Applicable tubing size^{Note)}

Symbol	Connection tubing size	Body class					
		2	3	4	5	6	
Metric size							
03	3 x 2	●					
04	4 x 3	●					
06	6 x 4	○	●				
08	8 x 6		●				
10	10 x 8			○	●		
12	12 x 10				○	●	
19	19 x 16					○	
25	25 x 22					○	
Inch size							
03	1/8" x 0.086"	●					
05	3/16" x 1/8"	●					
07	1/4" x 5/32"	○	●				
11	3/8" x 1/4"		○	●			
13	1/2" x 3/8"			○	●		
19	3/4" x 5/8"					○	
25	1" x 7/8"					○	

○ Basic size ● With reducer

Note) Refer to page 846 for details of the applicable tubing sizes.

5 Port B (OUT) different dia. size

Symbol	Application
Nii	Ports A & B same size
Refer to the applicable tubing size table to the left.	Different diameter tubings can be selected within the same body class.

6 Pilot port type

Symbol	Fitting type	Connection tubing O.D.
Nii	LQ1 integrated fitting	Connection tubing O.D. 1/8" (ø3)
M	LQ1 integrated fitting	Connection tubing O.D. ø4
R	Threaded	Rc1/8
N	Threaded	NPT1/8

7 Pilot port direction

Symbol	Direction
Nii	1
P2	2
P3	3
P4	4
P5	5
P6	6
P7	7
P8	8

Pilot port piping direction

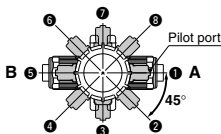

* Specify the piping direction by part number when ordering the product. Do not change the pilot port direction. (Refer to Precautions on page 846.)

Air Operated, 0.5 MPa Back Pressure Tolerant Insert Bushing, Integrated Fitting Type **LVQ□□H Series**

8 Option 1

Nii	None
1	With flow rate adjustment
2	With by-pass
3	With flow rate adjustment & by-pass
4	With indicator
24	With indicator & by-pass







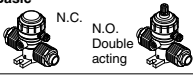
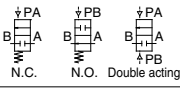

Note) Refer to variations in the table below for valve type and option 1 combinations. Options in the same table cannot be combined each other.

9 Option 2

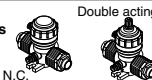
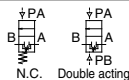
Symbol	Applicable option					Note
	1	2	3	4	24	
Nii	○	○	○	○	○	—
K	○	○	○	○	○	Buffer material FFKM
N	○	○	○	○	○	For ammonium hydroxide
P	—	—	—	○	—	High flow type LVQ6□ only

Note) Options 2 in the same table cannot be combined each other.

Variations

Type	Symbol	Valve type	Model					
			LVQ20H	LVQ30H	LVQ40H	LVQ50H	LVQ60H	
			Orifice diameter					
		Tubing O.D.		6	10	12	19	25
		Metric		1/4	3/8	1/2	3/4	1
		Inch		1/4	3/8	1/2	3/4	1
Basic 		N.C.	○	○	○	○	○	
		Double acting	○	○	○	○	○	
With flow rate adjustment 		N.C.	○	○	○	○		
With by-pass 		N.C.	○	○	○	○		
		Double acting	○	○	○	○	○	
With flow rate adjustment & by-pass 		N.C.	○	○	○	○		
With indicator 		N.C.	○	○	○	○		
With indicator & by-pass 		N.C.	○	○	○	○		

- LVQ
- LVA
- LVH
- LVQ
- LVP
- LVW
- LQ1
- LQ3
- LVN
- LQHB
- TL
- TIL
- TLM
- TILM
- TD
- TID
- TH
- TIH

Air Operated, 0.5 MPa Back Pressure Tolerant Flare, Integrated Fitting Type Hyper Fitting

LVQ□□H-Z Series

RoHS

How to Order

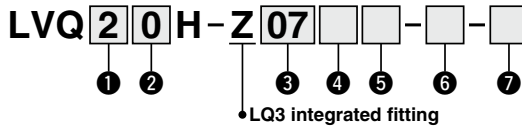

1 Body class

Symbol	Body class	Orifice dia.
2	2	ø4
3	3	ø8
4	4	ø10
5	5	ø16
6	6	ø22

4 Pilot port type

Symbol	With LQ3 fitting	Connection tubing size
Nll	With LQ3 fitting	1/8" x 0.086" (3 x 2) ^(Note)
M	With LQ3 fitting	Connection tubing size 4 x 3 ^(Note)
R	Threaded	Rc1/8
N	Threaded	NPT1/8

Note) Refer to page 846 for details of the applicable tubing sizes.

2 Valve type

0	N.C.
1	N.O.
2	Double acting

Note) For valve type combinations, refer to variations on the next page.

5 Pilot port direction

Symbol	Direction
Nll	1
P2	2
P3	3
P4	4
P5	5
P6	6
P7	7
P8	8

Pilot port piping direction

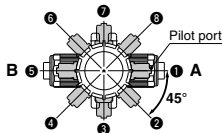

* Specify the piping direction by part number when ordering the product. Do not change the pilot port direction. (Refer to Precautions on page 846.)

3 Applicable tubing size^(Note)

Symbol	Connection tubing size	Body class					
		2	3	4	5	6	
Metric size							
03	3 x 2	○					
04	4 x 3	○					
06	6 x 4	○					
08	8 x 6		○				
10	10 x 8		○				
12	12 x 10			○			
19	19 x 16				○		
25	25 x 22					○	
Inch size							
07	1/4" x 5/32"	○					
11	3/8" x 1/4"		○				
13	1/2" x 3/8"			○			
19	3/4" x 5/8"				○		
25	1" x 7/8"					○	

Note) Refer to page 846 for details of the applicable tubing sizes.

Air Operated, 0.5 MPa Back Pressure Tolerant Insert Bushing, Integrated Fitting Type **LVQ**□□**H-Z Series**

6 Option 1

Nii	None
1	With flow rate adjustment
2	With by-pass
3	With flow rate adjustment & by-pass
4	With indicator
24	With indicator & by-pass









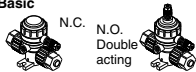
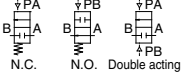

Note) Refer to variations in the table below for valve type and option 1 combinations. Options in the same table cannot be combined each other.

7 Option 2

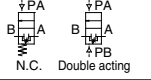
Symbol	Applicable option					Note
	1	2	3	4	24	
Nii	○	○	○	○	○	—
K	○	○	○	○	○	Buffer material FFKM
N	○	○	○	○	○	For ammonium hydroxide
P	—	—	—	○	—	High flow type LVQ6□ only

Note) Options 2 in the same table cannot be combined each other.

Variations

Type	Symbol	Valve type	Model					
			Orifice diameter					
			LVQ20H	LVQ30H	LVQ40H	LVQ50H	LVQ60H	
			Tubing O.D.					
			Metric					
			Inch					
Basic	 N.C. N.O. Double acting	 N.C. N.O. Double acting	N.C.	○	○	○	○	○
With flow rate adjustment		 N.C.	N.C.	○	○	○	○	○
With by-pass	 N.C. Double acting	 N.C. Double acting	N.C.	○	○	○	○	○
With flow rate adjustment & by-pass		 N.C.	N.C.	○	○	○	○	○
With indicator		 N.C.	N.C.	○	○	○	○	○
With indicator & by-pass		 N.C.	N.C.	○	○	○	○	○

- LVQ
- LVA
- LVH
- LVQ
- LVD
- LVQ
- LVP
- LVW
- LQ1
- LQ3
- LVN
- LQHB
- TL
- TIL
- TLM
- TILM
- TD
- TID
- TH
- TIH

Specifications

Model		LVQ20H	LVQ30H	LVQ40H	LVQ50H	LVQ60H
Tubing O.D. ^{Note 1)}	Metric	6	10	12	19	25
	Inch	1/4	3/8	1/2	3/4	1
Orifice diameter		ø4	ø8	ø10	ø16	ø22
Flow rate characteristics	Kv	0.3	1.1	1.6	4.2	6.8 (8.1) ^{Note 1)}
	Cv	0.35	1.3	1.9	5	8 (9.5) ^{Note 1)}
Withstand pressure (MPa)		1				
Operating pressure <A→B flow>		-98 kPa to 0.5 MPa ^{Note 3)}				
Back pressure (MPa)		0.5 or less				
Valve leakage (cm ³ /min)		0 (With water pressure)				
Pilot air pressure (MPa)		0.5 to 0.8				
Pilot port size ^{Note 2)}		1/8" (ø3), ø4, Rc 1/8, NPT 1/8				
Fluid temperature (°C)		0 to 100				
Ambient temperature (°C)		0 to 60				
Weight (kg)		0.08	0.17	0.22	0.70	0.81

Note 1) (): High flow type

Note 2) Refer to page 846 for details of the applicable tubing sizes.

Note 3) This product cannot be used for vacuum retention. Also, connecting the vacuum to the B port may reduce the life of the product.

Dimensions

Dimensions are the same as those of the standard specifications.

Applicable Different Diameter Tubings with Reducer (LVQ□□H_s)

Different diameter tubings can be selected (within the same body class) by using a nut and an insert bushing (reducer). ● With reducer

Body class	Connection tubing O.D.													
	Metric size						Inch size							
	4	6	8	10	12	19	25	1/8	3/16	1/4	3/8	1/2	3/4	1
2	●	○	—	—	—	—	—	●	●	○	○	—	—	—
3	—	●	●	○	—	—	—	—	—	●	○	—	—	—
4	—	—	—	●	○	—	—	—	—	—	●	○	—	—
5	—	—	—	—	●	○	—	—	—	—	—	●	○	—
6	—	—	—	—	—	●	○	—	—	—	—	—	●	○

Note) Refer to page 804 for information on changing tubing sizes.



⚠ Specific Product Precautions

Be sure to read this before handling the products. Refer to back page 50 for Safety Instructions and pages 845 and 846 for Air Operated Chemical Liquid Valve Precautions.

Piping

⚠ Caution

1. Connect tubing by special tools.

For information on tubing connection and special tools, please see the pamphlet "High Purity Fluoropolymer Fittings Hyper Fitting LQ1/2 Series Work Procedure Instructions" (M-E05-1) and "High Purity Fluoropolymer Fittings Hyper Fitting/Flare Type LQ3 Series Fitting Procedure" (M-E06-4). (The pamphlet can be downloaded from the SMC home page.)

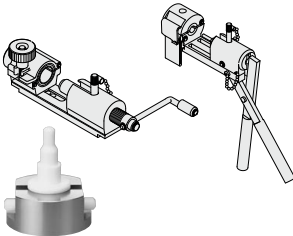

2. Tighten the nut until it touches the end surface of the body, and then tighten it an additional 1/8 turn. If the nut won't turn any further, then it means a sufficient tightening has occurred. Refer to the proper tightening torque shown below.

Tightening Torque for Piping

Body class	Torque (N·m)		
	LQ1	LQ2	LQ3
2	0.3 to 0.4	1.5 to 2.0	1.6 to 1.8
3	0.8 to 1.0	3.0 to 3.5	3.2 to 3.5
4	1.0 to 1.2	7.5 to 9.0	5.0 to 5.3
5	2.5 to 3.0	11.0 to 13.0	10.0 to 10.5
6	5.5 to 6.0	—	22.5 to 23.0

LVQ

LVA

LVH

LVJ

LVK

LVP

LVW

LQ1

LQ3

LVN

LQHB

TL
TIL

TLM
TILM

TD
TID

TH
TIH



LVQ Series Applicable Fluids

Material and Fluid Compatibility Check List for Air Operated Chemical Valves

Chemical	Compatibility
Acetone	<input type="radio"/> Note 1, 2)
Ammonium hydroxide	<input type="radio"/> Note 2)
Isobutyl alcohol	<input type="radio"/> Note 1, 2)
Isopropyl alcohol	<input type="radio"/> Note 1, 2)
Hydrochloric acid	<input type="radio"/>
Ozone (dry)	<input type="radio"/>
Hydrogen peroxide Concentration 5% or less, 50°C or less	<input type="radio"/>
Ethyl acetate	<input type="radio"/> Note 1, 2)
Butyl acetate	<input type="radio"/> Note 1, 2)
Nitric acid (except fuming nitric acid) Concentration 10% or less	<input type="radio"/> Note 2)
Deionized water (pure water)	<input type="radio"/>
Sodium hydroxide (caustic soda) Concentration 50% or less	<input type="radio"/>
Nitrogen gas	<input type="radio"/>
Super pure water	<input type="radio"/>
Toluene	<input type="radio"/> Note 1, 2)
Hydrofluoric acid	<input type="radio"/> Note 2)
Sulfuric acid (except fuming sulfuric acid)	<input type="radio"/> Note 2)
Phosphoric acid Concentration 80% or less	<input type="radio"/>

Table symbols : Can be used
 : Can be used in certain conditions
 : Cannot be used

The material and fluid compatibility check list provides reference values as a guide only.

Note 1) Since static electricity may be generated, implement suitable countermeasures.

Note 2) Use caution as permeation may occur. The permeated fluid may effect the parts of other materials.

- Compatibility is indicated for fluid temperatures of 100°C or less.
- The material and fluid compatibility check list provides reference values as a guide only, therefore we do not guarantee the application to our product.
- The data above is based on the information presented by the material manufacturers.
- SMC is not responsible for its accuracy and any damage happened because of this data.
- Use a fluid with a viscosity of 300 cp or less. Failure to do so may cause valve closing failure.



LVQ Series

Air Operated Chemical Liquid Valve/Precautions 1

Be sure to read this before handling the products.

Design / Selection

⚠ Warning

1. Confirm the specifications.

Give careful consideration to operating conditions such as the application, fluid and environment, and use within the operating ranges specified in this catalog.

2. Fluids

Operate after confirming the compatibility of the product's component materials with fluids, using the check list on page 844. Contact SMC regarding fluids other than those in the check list. Operate within the indicated fluid temperature range.

3. Maintenance space

Ensure the necessary space for maintenance and inspections.

4. Fluid pressure range

Keep the supplied fluid pressure within the operating pressure range specified in this catalog.

5. Ambient environment

Install the product in an environment where there is no effect from radiant heat caused by heat sources, etc., and use within the ambient operating temperature range. After confirming the compatibility of the product's component materials with the ambient environment, operate so that fluid does not adhere to the product's exterior surfaces.

6. Liquid seals

When circulating fluid

Provide a relief valve in the system so that fluid does not get into the liquid seal circuit.

7. Countermeasures for static electricity

Since static electricity may be generated depending on the fluid being used, implement suitable countermeasures.

Mounting

⚠ Warning

1. If air leakage increases or equipment does not operate properly, stop operation.

After mounting, perform suitable function and leak tests to confirm that the mounting is correct.

2. Operation manual

Mount and operate the product after reading the manual carefully and understanding its contents. Also, keep the manual where it can be referred to as necessary.

Piping

⚠ Caution

1. Preparation before piping

Before piping is connected, it should be thoroughly blown out with air (flushing) or washed to remove chips, cutting oil and other debris from inside the pipe.

Install piping so that it does not apply pulling, pressing, bending or other forces on the valve body.

2. Use the tightening torques shown below for the threaded pilot port.

Tightening Torque for Pilot Port

Pilot port	Torque (N·m)
Rc, NPT 1/8	0.8 to 1.0

3. Metal fittings

In the case of threaded pilot port, do not pipe the metal fittings which can cause damage to the thread part.

4. For information on tubing connection and special tools, please see the pamphlet "High Purity Fluoropolymer Fittings Hyper Fitting LQ1/2 Series Work Procedure Instructions" (M-E05-1) or "High Purity Fluoropolymer Fittings Hyper Fitting/Flare Type LQ3 Series Fitting Procedure" (M-E06-4). (The pamphlets can be downloaded from the SMC home page.)

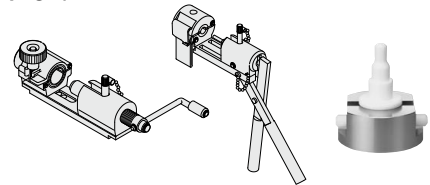

Operating Air Supply

⚠ Warning

1. Use clean air.

Do not use compressed air which includes chemicals, synthetic oils containing organic solvents, salt, or corrosive gases, etc., as this may cause damage or malfunction.

LVC

LVA

LVH

LVD

LVQ

LVP

LVW

LQ1

LQ3

LVN

LQHB

TL

TIL

TLM

TILM

TD

TID

TH

TIH



LVQ Series

Air Operated Chemical Liquid Valve/Precautions 2

Be sure to read this before handling the products.

Use of Tubing

Caution

1. Refer to the applicable tubing sizes shown below for tubing to be used.

Applicable tubing sizes

	Connection tubing size	O.D. (mm)		Internal thickness (mm)	
		Standard size	Tolerance	Standard size	Tolerance
Metric sizes	ø3 x ø2	3.0	+0.2 -0.1	0.5	±0.06
	ø4 x ø3	4.0			
	ø6 x ø4	6.0			
	ø8 x ø6	8.0		1.0	
	ø10 x ø8	10.0			
	ø12 x ø10	12.0			
Inch sizes	ø19 x ø16	19.0	+0.3 -0.1	1.5	±0.15
	ø25 x ø22	25.0			
	1/8" x 0.086"	3.18			
	3/16" x 1/8"	4.75			
	1/4" x 5/32"	6.35		1.2	
	3/8" x 1/4"	9.53			
	1/2" x 3/8"	12.7		1.6	
3/4" x 5/8"	19.0				
1" x 7/8"	25.4				

Operating Environment

Warning

1. Do not use in a location having an explosive atmosphere.
2. Do not use in locations where vibration or impact occurs.
3. Do not use in locations where radiated heat will be received from nearby heat sources.
4. Do not use in environments which exceed the ambient temperature specifications of the product.

Maintenance

Warning

1. Maintenance should be performed in accordance with the procedures in the operation manual.

Incorrect handling can cause damage or malfunction of machinery and equipment, etc.

2. Before removing equipment or compressed air supply/exhaust devices, shut off the air and power supplies, and exhaust compressed air from the system.

Further, when restarting equipment after re-mounting or replacement, first confirm safety and then check the equipment for normal operation.

3. Perform work after removing residual chemicals and carefully replacing them with pure water or air, etc.
4. Do not disassemble the product. Products which have been disassembled cannot be guaranteed.

If disassembly is necessary, contact SMC.

5. In order to obtain optimum performance from valves, perform periodic inspections to confirm that there are no leaks from valves or fittings, etc.

Maintenance

Caution

1. Removal of drainage

Flush drainage from filters regularly.

Precautions

Warning

1. Operate within the ranges of the maximum operating pressure and back pressure.
2. Do not change the pilot port direction. Products which have been disassembled cannot be guaranteed.

Caution

1. Please note that when the product is shipped from the factory, gases such as N₂ and air may leak from the valve at a rate of 1 cm³/min (when pressurized).
2. When operated at a very low flow rate, the product with flow rate adjustment may vibrate, etc. depending on the operating conditions. Therefore, operate only after careful examination of the flow rate, pressure and piping conditions.
3. Water hammering may occur depending on the fluid pressure conditions. In most cases, improvement is possible by adjusting the pilot pressure with a speed controller, etc., but the flow rate, pressure and piping conditions should be reviewed.
4. To adjust the flow rate with flow rate adjustment, open gradually starting from the fully closed condition.

Opening is accomplished by turning the adjustment knob counterclockwise. Additionally, do not apply any unreasonable force to the adjustment handle when nearing a fully opened or closed condition. This may result in deformation of the orifice sheet surface or damage to the threaded part of the adjustment handle.

The handle is in the fully closed condition when the product is shipped from the factory.

In addition, do not apply excessive force to the adjustment knob even when the lock nut is in a tightened state. Operate the adjustment knob when the lock nut is in a loosened state.

5. After long periods of nonuse, perform a test run before beginning regular operation.
6. Since the product is packaged in a clean room, use sufficient care in handling when opened.

Return of Product

Warning

If the product to be returned is contaminated or is possibly contaminated with substances that are harmful to humans, for safety reasons, please contact SMC beforehand and then employ a specialist cleaning company to decontaminate the product. After the decontamination prescribed above has been carried out, submit a Product Return Request Sheet or the Detoxification/Decontamination Certificate to SMC and await SMC's approval and further instructions before attempting to return the item.

Please refer to the International Chemical Safety Cards (ICSC) for a list of harmful substances.

If you have any further questions, please don't hesitate to contact your SMC sales representative.