



Operation Manual

Original Instructions

Thermo Chiller

HRZD020-WS-WS, HRZD020-W1S-W1S

HRZD020-W1S-WS, HRZD020-WS-W1S

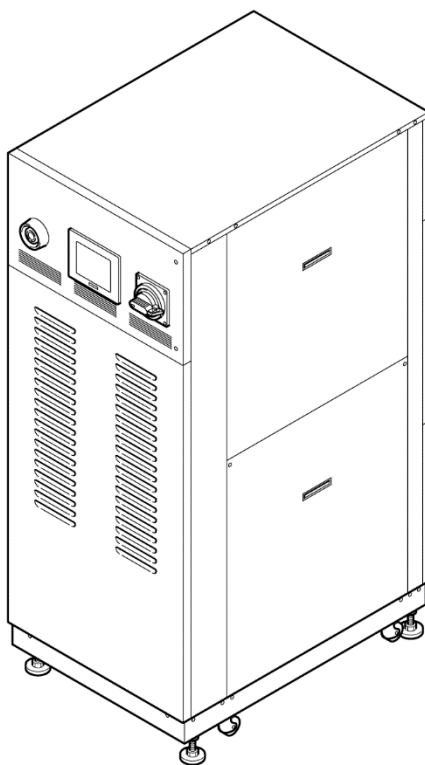

SMC Corporation



Keep this manual available whenever necessary

To the users

Thank you for purchasing SMC's HRZ Thermo Chiller (hereinafter referred to as the "Product").

For safety and long life of the product, be sure to read this operation manual (hereinafter referred to as the "manual") and clearly understand the contents.

- Be sure to read and follow all instructions noted with "Warning" or "Caution" in this manual.
- This manual is intended to explain the installation and operation of the product. Only people who understands the basic operation of the product through this manual or who performs installation and operation of or has basic knowledge about industrial machines are allowed to work on the product.
- This manual and other documents attached to the product do not constitute a contract, and will not affect any existing agreements or commitments.
- It is strictly prohibited to copy this manual entirely or partially for the use by the third party without prior permission from SMC.
- A Service Manual is supplied in addition to this manual and provides explanations of inspection, troubleshooting, and in-depth repair of the product. The Service Manual is intended for service personnel that have completed service training provided by SMC. Only those who fall under the above condition are allowed to perform maintenance and repair of the product with the use of the Service Manual.

Note: The contents of this manual are subject to change without notice.

Table of Contents

Chapter 1	Safety Instructions	1-1
1.1	Before Using this Product	1-1
1.2	Hazards	1-2
1.2.1	Hazard Levels	1-2
1.2.2	Definitions of “Serious injury” and “Minor injury”	1-2
1.2.3	Symbols	1-3
1.3	Hazard Warning Label	1-4
1.3.1	Type of hazard warning label	1-4
1.3.2	Location of hazard warning label	1-5
1.4	Location of Model Label	1-7
1.5	Safety Measures	1-8
1.5.1	Safety Precautions	1-8
1.5.2	Safety Interlock system	1-10
1.5.3	Lockout/Tagout	1-11
1.5.4	Protective equipment	1-13
1.6	Emergency Measures	1-14
1.6.1	Emergency off [EMO] switch	1-14
1.7	Waste Disposal	1-16
1.7.1	Disposal of refrigerant and compressor oil	1-16
1.7.2	Disposal of circulating fluid	1-17
1.7.3	Disposal of product	1-17
1.7.4	Battery	1-17
1.8	Material Safety Data Sheet (MSDS)	1-17
Chapter 2	Name of Each Section	2-1
2.1	Name of Each Section	2-1
Chapter 3	Transporting and Installation	3-1
3.1	Transporting	3-1
3.1.1	Transporting with forklift	3-2
3.1.2	Transporting with caster	3-3
3.2	Installation	3-3
3.2.1	Installation conditions	3-4
3.2.2	Installation location and maintenance work area	3-5
3.3	Procedure for Installation	3-6
3.3.1	Installation	3-6
3.3.2	Procedure for product securing	3-6
3.3.3	Wiring installation	3-7
3.3.4	Procedures for wiring installation	3-9

3.3.5	Installation of circulating fluid and facility water piping	3-13
Chapter 4	Product Startup and Shutdown	4-1
4.1	Pre-check	4-1
4.1.1	Installation condition	4-1
4.1.2	Cable connection	4-1
4.1.3	Installation of circulating fluid and facility water piping	4-1
4.1.4	Operating signal from your system	4-1
4.1.5	Check of emergency off [EMO] switch	4-1
4.2	Opening of Facility Water Valve	4-1
4.3	Filling of Circulating Fluid	4-2
4.3.1	Preparation of circulating fluid	4-2
4.3.2	Fill of circulating fluid	4-3
4.4	Requirement for Product Startup	4-4
4.4.1	Turning ON power	4-4
4.4.2	Circulating fluid temperature setting	4-5
4.5	Product Startup and Shutdown	4-5
4.5.1	Product startup	4-5
4.5.2	Product shutdown	4-5
Chapter 5	Product Operation	5-1
5.1	Operation Touch Panel	5-1
5.2	Flow Chart of Operation Screen	5-2
5.2.1	Flow Chart of Operation Screen (1)	5-2
5.2.2	Flow Chart of Operation Screen (2)	5-3
5.3	Operation Screen	5-4
5.3.1	Initial screen	5-4
5.3.2	Main screen	5-5
5.3.3	Special mode	5-6
5.3.4	CH1(2) setting data screen 1, 2	5-7
5.3.5	CH1(2) setting data screen 3	5-8
5.3.6	Mode selection screen	5-11
5.3.7	Status screen 1	5-14
5.3.8	Status screen 2	5-15
5.3.9	Status screen 3, 4	5-16
5.3.10	Status screen 5	5-18
5.3.11	Alarm list screen	5-19
5.3.12	Alarm history screen	5-20
5.3.13	Detail setting screen 1	5-22
5.3.14	Detail setting screen 2	5-23
5.3.15	Display setting screen 1	5-24
5.3.16	Display setting screen 2	5-25

5.3.17	Time setting screen	5-25
5.3.18	Communication setting screen	5-27
5.3.19	Serial communication setting screen 1	5-28
5.3.20	Serial communication setting screen 2	5-29
5.3.21	CH1(2)DIO communication setting screen 1.....	5-32
5.3.22	CH1(2)DIO communication setting screen 2.....	5-33
5.3.23	CH1(2) analog input setting screen.....	5-36
5.3.24	CH1(2) analog output setting screen 1, 2	5-40
5.3.25	Control setting screen	5-44
5.3.26	CH1(2) control setting screen	5-44
5.3.27	CH1(2) Compressor ECO Limit setting screen	5-45
5.3.28	CH1(2) Pump ECO Limit setting screen	5-46
5.3.29	CH1(2) offset setting screen.....	5-47
5.3.30	CH1(2) circulating fluid discharge pressure limit setting screen	5-48
5.3.31	Maintenance screen	5-49
5.3.32	Auto tuning screen	5-50
5.3.33	EV opening adjustment screen	5-51
5.3.34	Purge mode screen	5-52
Chapter 6	Error Message and Troubleshooting	6-1
6.1	Error Message.....	6-1
6.2	Troubleshooting.....	6-2
Chapter 7	Product Maintenance	7-1
7.1	Water Quality Management	7-1
7.2	Inspection and Cleaning.....	7-2
7.2.1	Daily inspection	7-2
7.2.2	Quarterly inspection	7-3
7.3	Storage	7-3
7.3.1	Draining of circulating fluid out of tank	7-4
7.3.2	Draining of facility water	7-6
7.4	Periodic Replacement Parts.....	7-6
Chapter 8	Appendix.....	8-1
8.1	Specification	8-1
8.1.1	Product specification	8-1
8.1.2	Refrigerant with GWP reference	8-8
8.1.3	Communication specification.....	8-9
8.1.4	Alarm signal selection	8-11
8.2	Outer Dimensions	8-12
8.3	Flow Chart.....	8-13
8.3.1	HRZD020-WS-WS, HRZD020-W1S-W1S, HRZD020-W1S-WS, HRZD020-WS-W1S....	8-13
8.4	Offset Function	8-14

8.4.1	Example of offset function	8-15
8.5	BAND/READY Function.....	8-17
8.6	Anchor Bolt Mounting Position	8-18
8.7	Compliance.....	8-19
8.8	Thermo Chiller Daily Inspection Sheet	8-20
Chapter 9	Limited warranty and Disclaimer/ Compliance	
Requirements	9-1

Chapter 1 Safety Instructions



Before using the product, be sure to read and understand all the important actions highlighted in this manual.

1.1 Before Using this Product

- This "Safety" chapter describes the safety-related items that users should be aware of upon handling this system.
- This system, which is operated under high voltage, is outfitted with the parts that cause a rise or drop in temperature and rotating parts when it is in action. All personnel who work with or around this system are required to thoroughly read and understand the safety-related items in this manual prior to working with or around this system.
- The relevant personnel must receive proper safety education prior to work training on this system. Otherwise, personnel may be exposed to hazards. Never conduct work training without giving proper consideration to safety.
- This manual is not intended to be used as a manual for comprehensive safety and hygiene education. Such a manual should be provided by a safety training manager.
- A safety manager is responsible for observing safety standards. Operators and maintainers, however, are to have individual responsibilities for complying with the safety standard in his/her daily work.
- Operators and maintainers must individually take account of safety and assure a proper working area and working environment.
- This appliance is not intended for use by persons (including children) with reduced physical, sensory or mental capabilities, or lack of experience and knowledge, unless they have been given supervision or instruction concerning use of the appliance by a person responsible for their safety.
- Save this manual at a designated place for reference when necessary.

1.2 Hazards

1.2.1 Hazard Levels

The instructions given in this manual aim to assure the safe and correct operation of the product, and to prevent injury of operators or damage to the product. These instructions are grouped into three categories, Danger, Warning and Caution, which indicate the level of hazard, damage and also the degree of emergency. All safety critical information should be carefully observed at all times.

DANGER, WARNING and CAUTION signs are in order according to hazard severity (DANGER > WARNING > CAUTION).

 DANGER
“DANGER”: A hazard that WILL cause serious personal injury or death during operation.

 WARNING
“WARNING”: A hazard that MAY cause serious personal injury or death during operation.

 CAUTION
“CAUTION”: A hazard that MAY cause minor personal injury.

CAUTION
“CAUTION without exclamation symbol”: A hazard that MAY cause damage or failure of the product, facility, devices, ect.

[Tips]

Tips are provided when there is information personnel are required to be aware of for product operation and maintenance. If the task carries useful information, the relevant tips are given as well.

1.2.2 Definitions of “Serious injury” and “Minor injury”

■ “Serious injury”

This term describes injuries that result in after effects including loss of eyesight, burns, electrical shock, fracture, poisoning, etc. and requires long-term treatment or hospitalisation.

■ “Minor injury”

This term describes injuries that do not need long-term treatment or hospitalisation. (Others excluded from serious injury.)

1.2.3 Symbols

This manual provides the following symbols in addition to “Danger”, “Warning”, and “Caution” to highlight particular types of hazards.

■ Symbol of electrical hazard

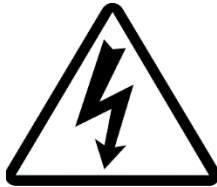

This symbol warns you of potential electrical shock.

■ Symbol of heat hazard



This symbol warns you of a potential hot surface or burn.

■ Symbol of low temperature hazard



This symbol warns you of potential frostbite.

■ Symbol of “Don’t”



This sign stands for prohibited actions.

■ Symbol of “Do”



This sign stands for actions that must be followed.

1.3 Hazard Warning Label

The hazard warning labels are applied to the sections of the product where potential hazards are present during product operation or maintenance.

The hazard warning labels are in appropriate sizes and colours to get attention of the operator. They contain symbols in addition to the descriptions of the warnings.

1.3.1 Type of hazard warning label

The hazard warning labels affixed on the product are listed below.

■ Labels of high voltage hazard

[High voltage hazard]

This warning label is affixed on the cover panel which isolates the parts where high voltage is used. Do not remove the cover panels that are not designated in this manual.



Figure 1-1 Hazard warning label No. 1



Figure 1-2 Hazard warning label No.2

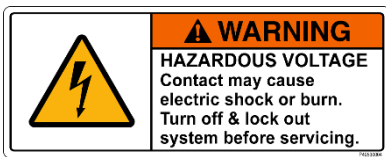

Figure 1-3 Hazard warning label No. 3

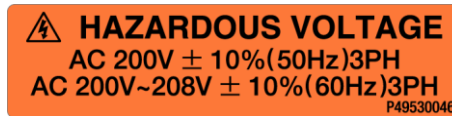

Figure 1-4 Hazard warning label No. 4

■ Labels of hot/cold surface hazard

[Hot/cold surface hazard]

This warning label is affixed on the surface that can be at high or low temperatures and carry potential of burns or frostbite if touched. Residual heat may cause burns despite the power being turned OFF. Be sure the surface has cooled before starting work.



Figure 1-5 Hazard warning label No.5

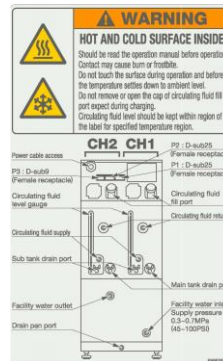





Figure 1-6 Hazard warning label No.6

1.3.2 Location of hazard warning label

⚠ WARNING	
	Do not peel off or deface the hazard warning labels.
⚠ WARNING	
	<ul style="list-style-type: none">● Confirm the locations of all hazard warning labels.● Read the contents of the hazard warning labels carefully and keep them in mind.
⚠ WARNING	
	Users are NOT allowed to change the locations of the hazard warning labels. If replacing a reeled off or worn out label, make sure to affix a new label to exactly the same location of the old label.

■ High voltage hazard

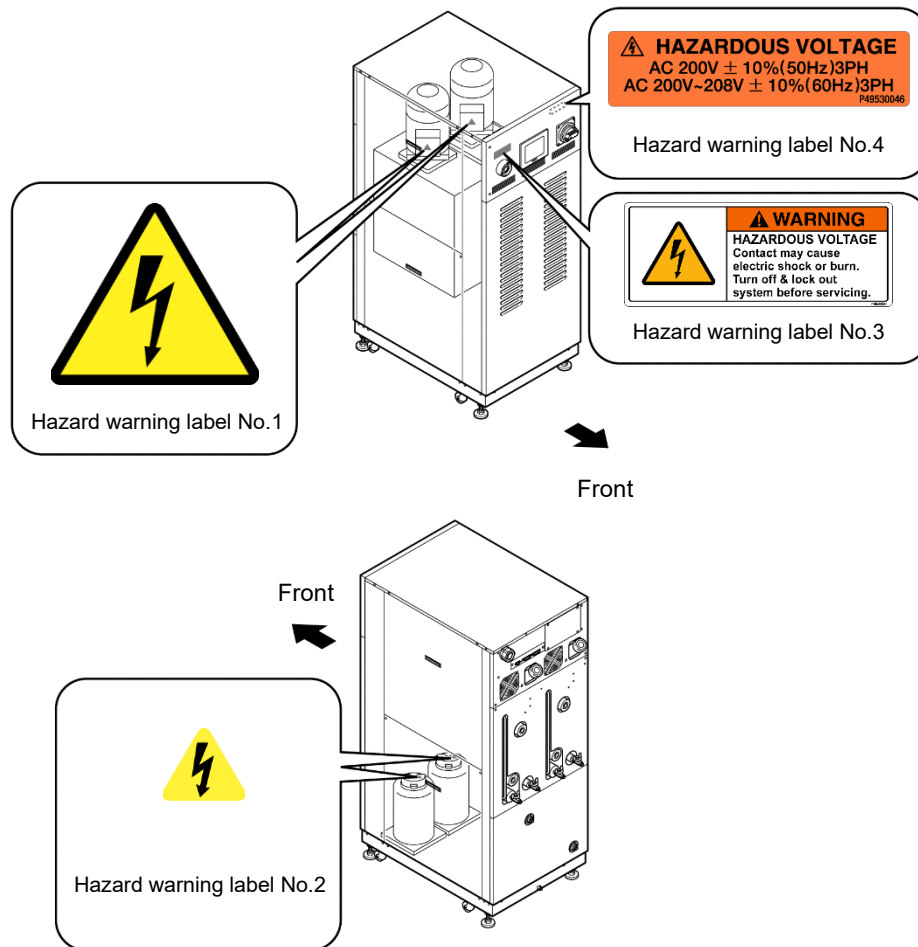

Figure 1-7 High Voltage Hazard

■ Hot/cold surface hazard

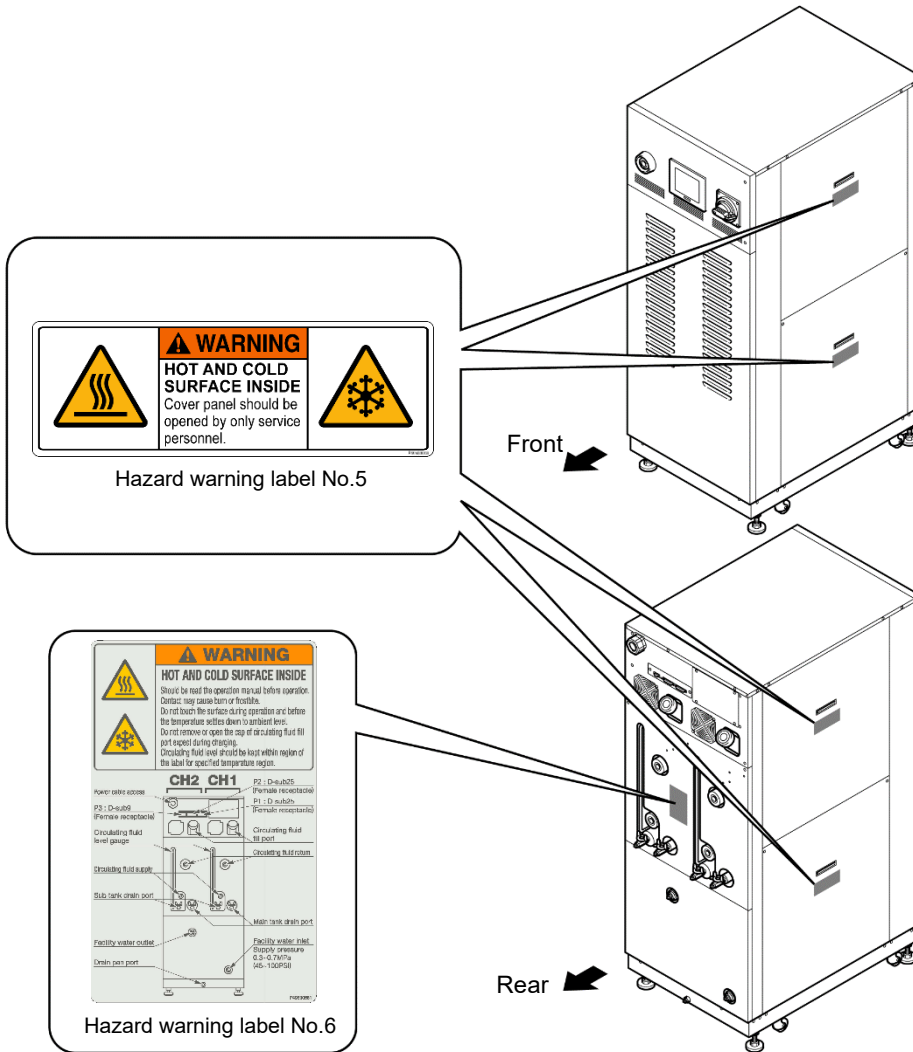

Figure 1-8 Hot/Cold Surface Hazard

1.4 Location of Model Label

Information about the product, such as Serial No. and Model No. can be found on the model label. This information is needed when contacting an SMC sales distributor.

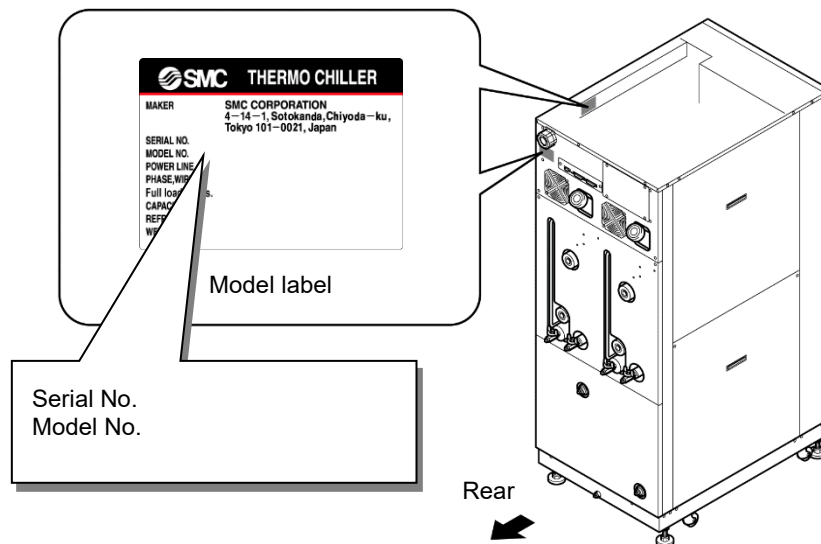

Figure 1-9 Location of Model Label

1.5 Safety Measures

1.5.1 Safety Precautions

While the product is protected by various safety measures including the safety interlocks, the following basic safety precautions should be observed to assure further safe operations.

WARNING



Follow the instructions below when using the product. Failure to follow the instructions may cause an accident or injury.

- Read and understand this manual carefully before using the product.
- Before starting maintenance of the product, be sure to lock out and tag out the breaker of user's power supply.
- If operating the product during maintenance, be sure to inform all workers nearby.
- Use only the correct tools and procedures when installing or maintaining the product.
- Use personal protective equipment where specified (“1.5.4 Protective equipment”).
- Check all parts and screws are fitted correctly and securely after maintenance.
- Avoid working in a drunken or sick condition, which might cause an accident.
- Do not remove the panels except for the cases permitted in this manual.
- Do not remove the panels during operation.
- Use assistance to carry object over 20 kg.
- Refer to your safety manual for emergency evacuation.

WARNING



1. The compatibility of the product is the responsibility of the person who designs the equipment or decides its specifications. Since the product specified here is used under various operating conditions, its compatibility with specific equipment must be decided by the person who designs the equipment or decides its specifications based on necessary analysis and test results. The expected performance and safety assurance of the equipment will be the responsibility of the person who has determined its compatibility with the product. This person should also continuously review all specifications of the product referring to its latest catalog information, with a view to giving due consideration to any possibility of equipment failure when configuring the equipment.

2. Only personnel with appropriate training should operate machinery and equipment. The product specified here may become unsafe if handled incorrectly. The assembly, operation and maintenance of machines or equipment including our products must be performed by an operator who is appropriately trained and experienced.

3. Our products cannot be used beyond their specifications. Our products are not developed, designed, and manufactured to be used under the following conditions or environments. Use under such conditions or environments is not covered.

A: Conditions and environments outside of the given specifications, or use outdoors or in a place exposed to direct sunlight.

B: Use for nuclear power, railways, aviation, space equipment, ships, vehicles, military application, equipment affecting human life, body, and property, fuel equipment, entertainment equipment, emergency shut-off circuits, press clutches, brake circuits, safety equipment, etc., and use for applications that do not conform to standard specifications such as catalogs and operation manuals.

C: Use for interlock circuits, except for use with double interlock such as installing a mechanical protection function in case of failure.

Please periodically inspect the product to confirm that the product is operating properly.

CAUTION



We develop, design, and manufacture our products to be used for automatic control equipment, and provide them for peaceful use in manufacturing business.

Use in non-manufacturing business is not covered.

Products we manufacture and sell cannot be used for the purpose of transactions or certification specified in the Measurement Act.

The new Measurement Act prohibits use of any unit other than SI units in Japan.

1.5.2 Safety Interlock system

■ Safety Interlock system

The function of the safety interlock system is not only to protect personnel by restricting operation that may cause damage to the product or the facility around it but also eliminate the danger relating to safety. The product is fitted with several interlock functions that are activated when improper operation or hazardous conditions occur. The product operation must be terminated when a safety interlock is activated.

An alarm message is displayed on the operation touch panel when a safety interlock is activated. See “Chapter 6 Error Message and Troubleshooting” for details on the alarms and troubleshooting or see section “Troubleshooting” in a separate volume of the “Service Manual”.

■ Front door

Product repair may require opening the front panel.

The breaker handle operation is available only with the front door closed.

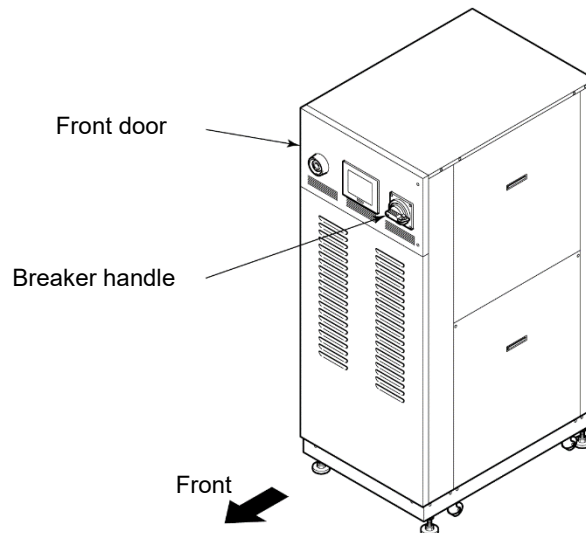

Figure 1-10 Front Door

1.5.3 Lockout/Tagout

■ Summary

Lockout of the product disables the main breaker operation to prevent electric shocks.

Tagout, to be placed on the locked out main breaker, prevents improper breaker operation (ON) conducted by other personnel.

See “■ Lockout procedure” in the following pages for a step-by-step guide to lockout/tagout.

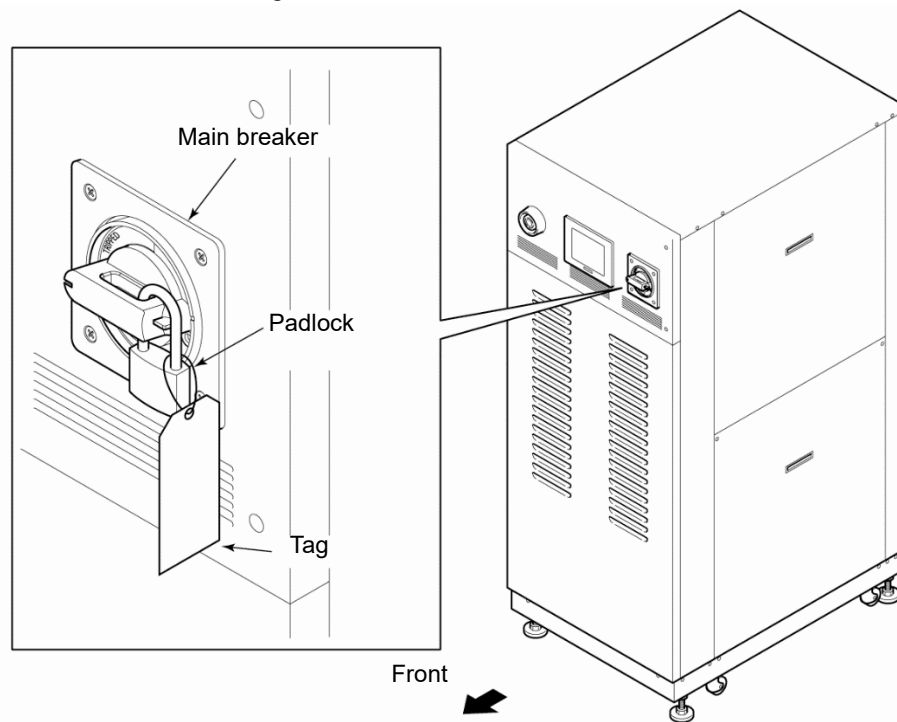

Figure 1-11 Lockout/Tagout

⚠ WARNING



- People performing service of the product should have an awareness of the importance of lockout. Thorough understanding of the procedures defined in this manual are required for product service.
- Lockout is allowed only when the product come to a full stop.
- A supervisor should be appointed to direct all personnel if multiple workers engage in system service. The supervisor is to perform lockout based on a full understanding of overall process conditions.
- Not only all personnel but new personnel that engage in service of this system should have an awareness of the importance of lockout and obtain thorough understanding of the lockout procedure.
- Any personnel working in an area with high voltage should be assigned with padlocks and tags. The key for the padlock is kept under the responsibility of the supervisor, and lockout release is performed upon completion of work.

■ Lockout procedure

⚠ WARNING



All service personnel must observe the restrictions applied during lockout and are required to perform lockout in accordance with this procedure. No service personnel is allowed to start, energize, or use the locked out product.

1. Turn the breaker handle to 'OFF ○'.

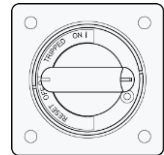

Figure 1-12 Breaker Handle at 'OFF ○'

2. Turn the breaker handle to 'RESET'.

- Hold the breaker handle with hand.
The handle turns back to 'OFF ○' if released.

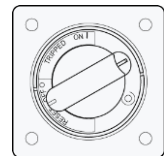

Figure 1-13 Breaker Handle at 'RESET'

3. Push the lock pushing part of the breaker handle, and turn the breaker handle to 'OFF ○'.

- The lock mechanism part is to remain opened.

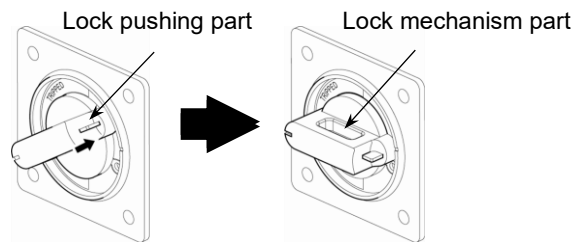

Figure 1-14 Pushing of Lock Mechanism Part

4. Lock the lock mechanism part with the padlock.

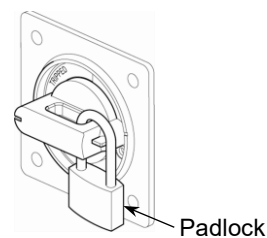

Figure 1-15 Breaker Lock

■ Releasing lockout

1. Remove the padlock from the lock mechanism part.

2. Turn the breaker handle to 'RESET'.

The lock mechanism part is closed.

- The handle turns back to 'OFF ○' if released.

1.5.4 Protective equipment

This manual specifies personal protective equipment for each work.

■ Transport, Installing and Uninstalling

CAUTION



Always use safety shoes, gloves and head protection when transporting, installing or uninstall the product.

■ Handling of circulating fluid

CAUTION



Always use safety shoes, gloves, mask, apron and eye protection when handling the circulating fluid.

■ Operation

CAUTION



Always use safety shoes and gloves when operating the product.

1.6 Emergency Measures

1.6.1 Emergency off [EMO] switch

Press the red emergency off [EMO] switch on the front of the product only if the need to shut off the power arises due to emergency such as natural disaster, fire, earthquake or personal injury.

The emergency off [EMO] switch is a large, red mushroom-shaped push button labeled with 'EMO' on it. The product comes to a halt if this button is pressed.

When the emergency off [EMO] switch is pressed, the control power for the product is shut off to bring the product to a stop. The main breaker of the product, however, is designed not to trip, which enables the motor circuit to remain partially energized. Please refer "8.1.3 Communication specification" in Chapter 8 Appendix on page 8-8 and construct a circuit which will cut off the power supply to the customer device when the Emergency Cutoff [EMO] switch is pressed using the EMO signal output from this device.

Restart of the product is enabled only when this button is reset manually.

■ Location of emergency off [EMO] switch

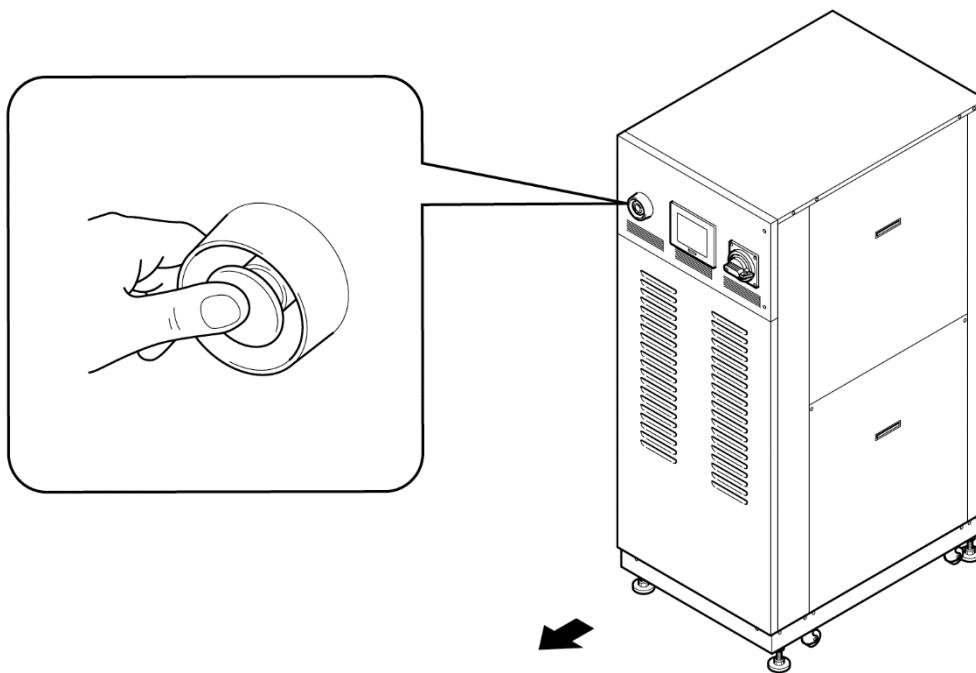

Figure 1-16 Location of Emergency Off [EMO] Switch

■ Reset of emergency off [EMO] switch

⚠ WARNING



No automatic recovery is applied to the emergency off [EMO] switch. Always eliminate the cause of activating the EMO before resetting. Potential serious accidents may occur if disregarded.

1. Before restarting, always make sure that the cause of the emergency off condition (The reason why the EMO switch was activated) has been eliminated from the power supplies, the product or peripheral equipment.

2. With the cause completely eliminated, turn the emergency off [EMO] switch clockwise to reset.

The EMO button returns to its original position.

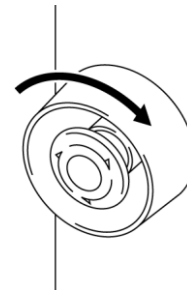

Figure 1-17 Emergency Off [EMO] Switch

⚠ WARNING



When the product is in remote mode, the remote mode is retained despite the power outage. Thus the system operation is to resume as the start signal is issued from your system.

3. When the power is restored the product restarts as normal.

1.7 Waste Disposal

WARNING



Always follow local regulations when disposing of this product or related waste.

1.7.1 Disposal of refrigerant and compressor oil

This product uses hydro-fluorocarbon type refrigerant (HFC) and compressor oil. Comply with the law and regulation in each country for the disposal of refrigerant and compressor oil. The type and quantity of refrigerant is described on the model label. (“1.4 Model Label”)

If these fluids need to be recovered, read and understand the instructions below carefully. If there is any unclear point, contact an SMC's sales distributor.

WARNING



- Only maintenance personnel or qualified people are allowed to open the cover panels of the unit.
- Do not mix the compressor oil with domestic waste for disposal. Also, the disposal of the waste must only be conducted by specific facilities that are permitted for that purpose.

WARNING



- Comply with the law and regulation in each country for the disposal of refrigerant and compressor oil.
- The release of refrigerant in to the atmosphere is banned by law. Recover it with specific equipment and dispose of it correctly.
- Only people who have sufficient knowledge and experience about the unit and its accessories are allowed to recover the refrigerant and compressor oil.

[Tips]

For the type and quantity of the refrigerant, see “Location of Model Label” on page 1-7.

1.7.2 Disposal of circulating fluid

The disposal of a circulating fluid must be handled by a specialized industrial waste disposal agency. Ensure all circulating fluid is disposed of by such agency.

1.7.3 Disposal of product

The disposal of the product must be handled by a specialized industrial waste disposal agency in accordance with local laws and regulations.

1.7.4 Battery

A battery is used in the touch panel of this product. Please inform this to the disposal agency when you dispose this product.

Battery Model: PFXZCBBT1

Manufacturer: Pro-face™/ Schneider Electric Japan Holdings Ltd.

Battery Lifetime: Approximately 5 years

Type: Manganese dioxide primary lithium battery

Nominal Voltage: 3V

Nominal Capacity: 550 mAh

Nominal Discharge Current: 0.2 mA

Weight: 6.8 g

Dimension: Diameter 24.5 mm × Height 5.0mm

The lifetime of the battery is approximately 5 years. When the battery is fully depleted, the internal clock and customer settings will be lost. Then finally an alarm “Setting Data Clear” will be shown.

After replacing the battery, set the internal clock and customer settings again.

*Pro-face™ is a trademark of Schneider Electric Japan Holdings Ltd.

1.8 Material Safety Data Sheet (MSDS)

If the material safety data sheets of chemicals supplied in the product are needed, contact an SMC's sales distributor.

Any chemicals used by the user must be accompanied by an MSDS.

Chapter 2 Name of Each Section

2.1 Name of Each Section

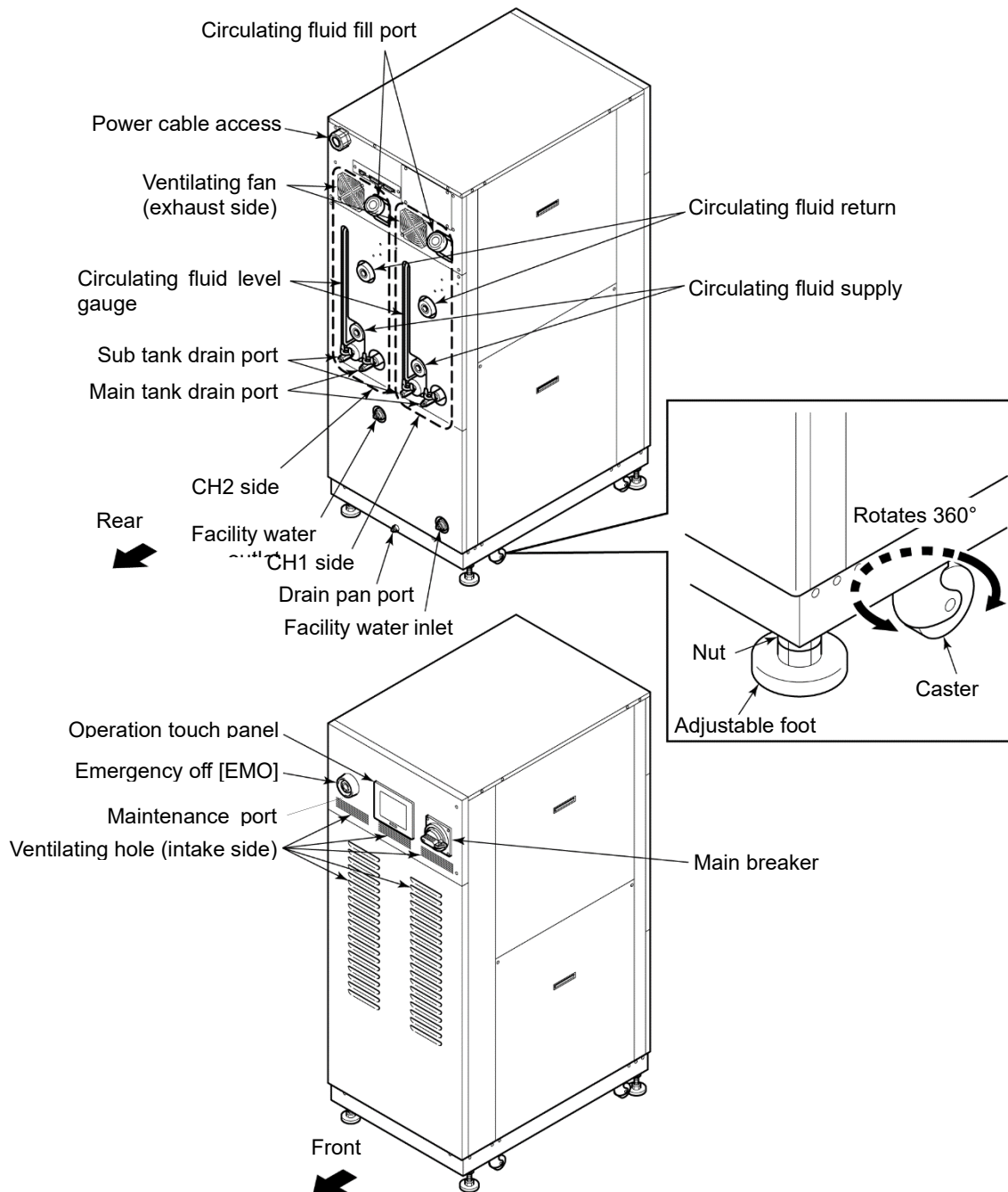

Figure 2-1 Name of Each Section

⚠ CAUTION

! When transporting the product with the casters, raise the adjustable feet (4 pcs.) to the highest position and lock them with the nuts. The adjustable foot at the lower position may cause damage to this system and personal injury through contact with the floor or steps during product transport.

Chapter 3 Transporting and Installation

WARNING



Proper procedure must be followed when using this product. Exercise caution to assure personnel safety during the installation, operation, maintenance and inspection of the product.

WARNING



Only personnel, who have adequate knowledge and experiences with not only the product but associated equipment are allowed to perform transport, installation, and maintenance involving potential hazardous task.

3.1 Transporting

The product is heavy and has potential danger during transport. Also, to prevent damage and failure of the product, be sure to follow these instructions for transport.

WARNING



If a fork lift is used for transport, check the forks are inserted in the correct place, refer to section "3.1.1 Transporting with forklift" .

CAUTION



Never lay down the product. Oil in the compressor drains into the refrigerant piping, which causes lubricant shortages leading to damage to the compressor.

CAUTION



Drain the remaining fluid out of the piping as much as possible. The remaining fluid may spill if disregarded.

CAUTION



Exercise caution not to damage the panel and piping with the forklift when transporting the product.

3.1.1 Transporting with forklift

⚠ WARNING



- Do not set the product on its side for transportation. Potential damage to this system carrying danger of personnel injury if disregarded.
- Do not insert the fork from the back as well as front.

⚠ WARNING



- This product is heavy, and requires a forklift to safely move it.
- Forklift insertion positions are on either left or right side of this product. Always insert the forks all the way through. Be careful not to hit the casters and adjustable feet.

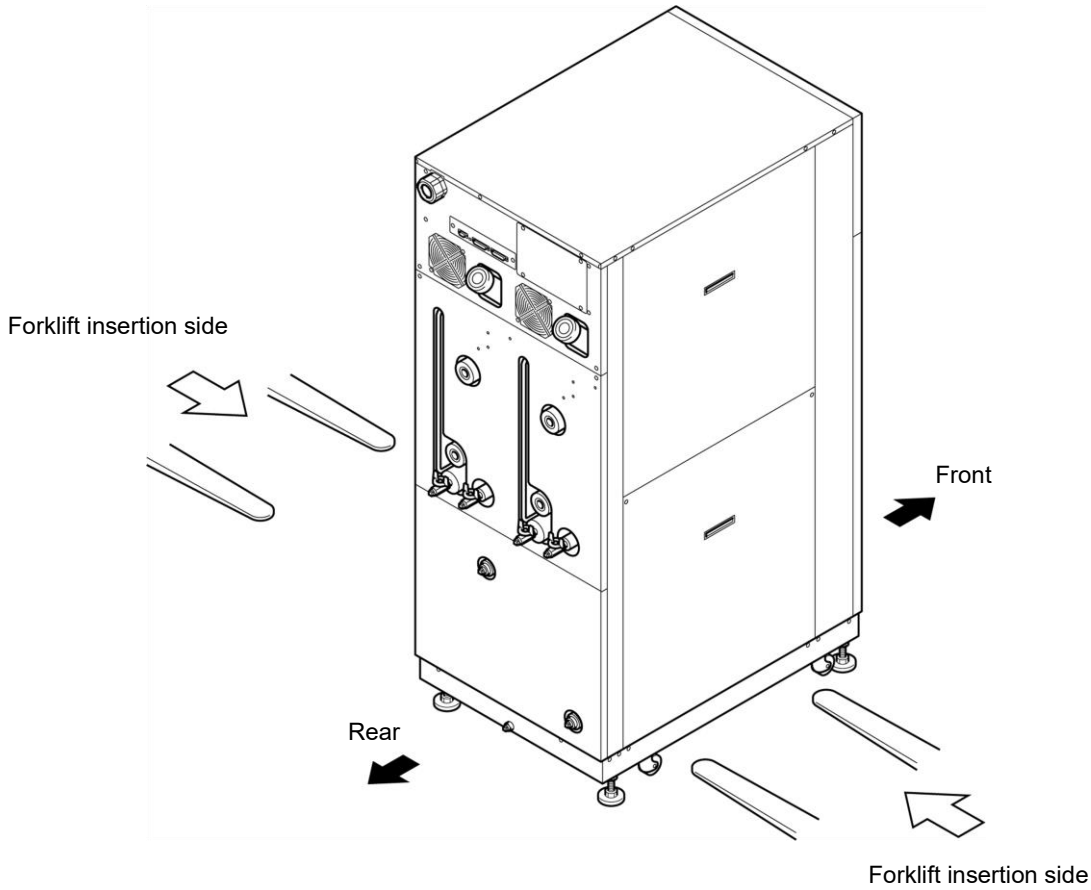

Figure 3-1 Transport with Forklift

3.1.2 Transporting with caster

WARNING



The product is heavy and requires assistance for this work. Exercise caution and look out for sloped surfaces such as ramps, etc.

CAUTION



Do not hold piping on the back of the product or panel handles when transporting with the casters. Potential damage to piping and panels may occur if disregarded.

3.2 Installation

WARNING



Product installation should be kept from areas with the potential of flammable gas leak. Ignition may occur if leaked gas is collected around the product.

WARNING



This product is NOT designed for outside use. Potential electric shock, fire and damage may occur if exposed to rain, water and dust.

CAUTION



The product is to be installed on a level floor that can withstand the weight of the product. Potential water leak and personal injury due to the product tipping over may occur if disregarded.

3.2.1 Installation conditions

The product must not be operated, installed, stored or transported in the following conditions. Potential malfunction or damage to the product may occur if disregarded.

The product does not conform to any Clean room specifications. The pump and ventilating fan inside the product generate particles.

- Location that is outside.
- Location that is exposed to water, water vapour, steam, salt water or oil.
- Location that is exposed to dust or powder material.
- Location that is exposed to corrosive gas, organic solvent, chemical solution, or flammable gas (the product is not flame-proof)
- Location where ambient temperature is out of the following range:

In transportation	-40 to 70°C (with no water or circulating fluid in piping)
In storage	0 to 50°C (with no water or circulating fluid in piping)
In operation	10 to 35°C
- Location where relative humidity is out of the following range:

In transportation and storage	15 to 85%
In operation	30 to 70%
- Location that is subjected to abrupt changes in temperature
- Location that is subjected to strong electromagnetic noise (intense electric field, intense magnetic field, or surges)
- Location that is subjected to static electricity, or conditions where static electricity can discharge to the product
- Location that is subjected to strong high frequencies raditation (microwaves)
- Location that is subjected to potential lightning srtike
- Location at altitudes of 1000m or higher (except for product storage and transport)
- Location where the product is affected by strong vibrations or impacts
- Condition that applies external force or weight causing the product to be damaged
- Location without adequate space for maintenance as required

3.2.2 Installation location and maintenance work area

The product does not have any ventilating hole on the right and left sides. Although it can be installed directly contacting walls or other devices, installation with maintenance space is recommended. (See “Figure 3-2)

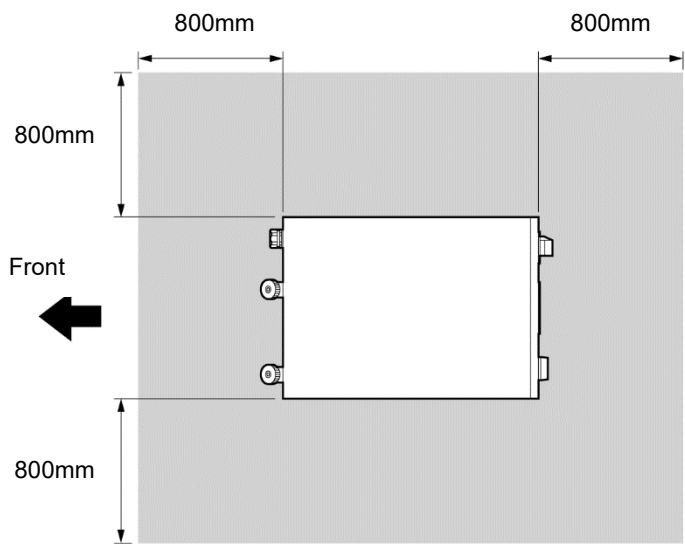

Figure 3-2 Recommended Installation Location

To save space, the product can be installed to allow access only in front and back for daily operation and inspection. For maintenance and repair work, additional access space is required for the left and right side of the product. We recommend a separate repair area, without taking space from installation site, to accommodate the needed extra space.

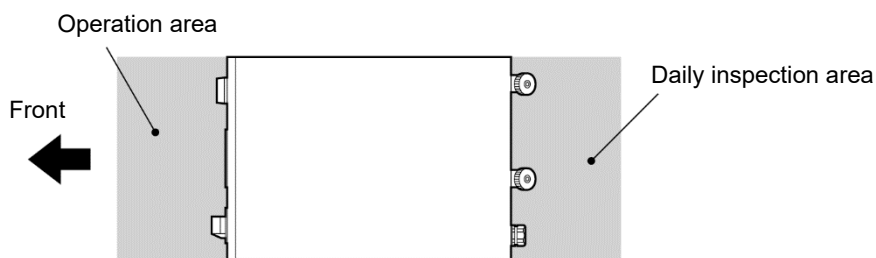

Figure 3-3 Installation Location

3.3 Procedure for Installation

⚠ CAUTION

- Anti-seismic bracket is recommended for the installation of the product.
- Preparation of anchor bolts suitable for floor material is your responsibility. M12-anchor bolts (8 pcs.) are required. See “Appendix 8.6 Anchor Bolt Mounting Position” in Chapter 8 on page 8-18”.

3.3.1 Installation

- Product installation should be on a vibration-free, stable and level surface.
- See “Appendix 8.2 Outer Dimensions” in Chapter 8 on page 8-12 for the dimensions of this product.

3.3.2 Procedure for product securing

Adjust and secure the adjustable feet of the product to secure the anti-seismic bracket.

1. Transfer the product to the installation site.

2. Adjust the adjustable foot with a 24-mm open end wrench.

- Level the product (using a leveler) by adjusting the adjustable feet.
- All adjustable feet (4 pcs.) must touch the floor completely.
- Casters need not be touching the floor.

3. Attach the anti-seismic bracket (4pcs.) to the front side and the rear side.

4. Secure the anti-seismic bracket with the anchor bolts. Repeat procedures for additional brackets.

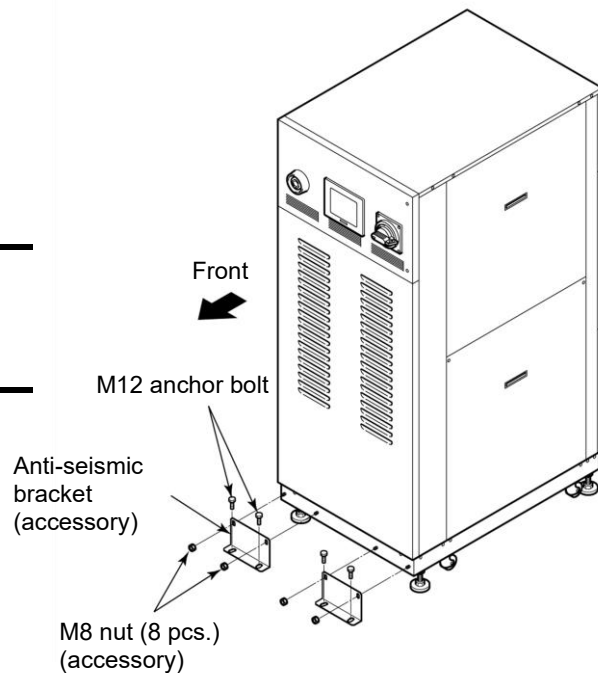



Figure 3-4 Anti-seismic Bracket Attachment

3.3.3 Wiring installation

⚠ WARNING



- Only designated personnel are allowed to install wiring.
- Be sure to turn OFF the power prior to wiring the product. Do not do any wiring when the system is energized.
- The system wiring requires not only a thorough connection with the designated cable but also securing to prevent loose connection. Poor connection and securing may cause electric shock, heat spots, fire or communication errors.
- Be sure to supply the power to this system according to specifications.
- Supply pure AC power. Potential malfunction may occur if a rectified AC with voltage rise (dv/dt) at zero crossing exceeds 40V /200μ sec.
- Always establish a connection to a ground for safety.
- Be sure that the ground connection is not made to a water pipe, gas pipe and lighting conductors.

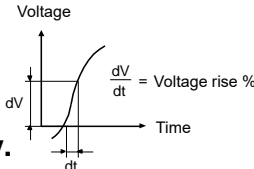

■ Power cable

The power cables are to be prepared under your responsibility, referring to the following table.

Table 3-1 Power Cable and Main Breaker (The Product)

Item		HRZD020-WS-WS HRZD020-W1S-W1S HRZD020-W1S-WS HRZD020-WS-W1S	
Power cable	Size (recommended)	6AWG×4-conductor	
	Crimp contact (recommended)	Breaker	R22-8
		Earth bar	R22-8
	Torque (recommended)	Breaker	6N•m
		Earth bar	12.5N•m
Power cable outer diameter		30mm – 32mm	
Main breaker (This Product)		60A	

[Tips]

When power cable outer diameter is not reasonable, it cannot insert it in a power cable access and cannot fix it definitely.

■ Communication connector

The communication connectors, including communication cables, are to be prepared under your responsibility, referring to the following table.

Table 3-2 Communication Connector

Connector	Type (for your system)
Contact signal / Analog (P1, P2 connectors)	D-Sub 25-pin (male)
Serial RS-485 or RS-232C (P3 connector)	D-Sub 9-pin (male)
Connector fitting screw (common to P1, P2, P3 connectors)	M2.6×0.45

■ Selection of the breaker for the customer's equipment (primary side)

⚠ CAUTION



This product is equipped with a breaker which has different operating characteristics depending on each model. For the customer's equipment (primary side), use the breaker whose operating time is equal to or longer than the breaker of this product. If the breaker with shorter operating time is connected, the customer's equipment could be cut off due to the inrush current of the motor of this product.

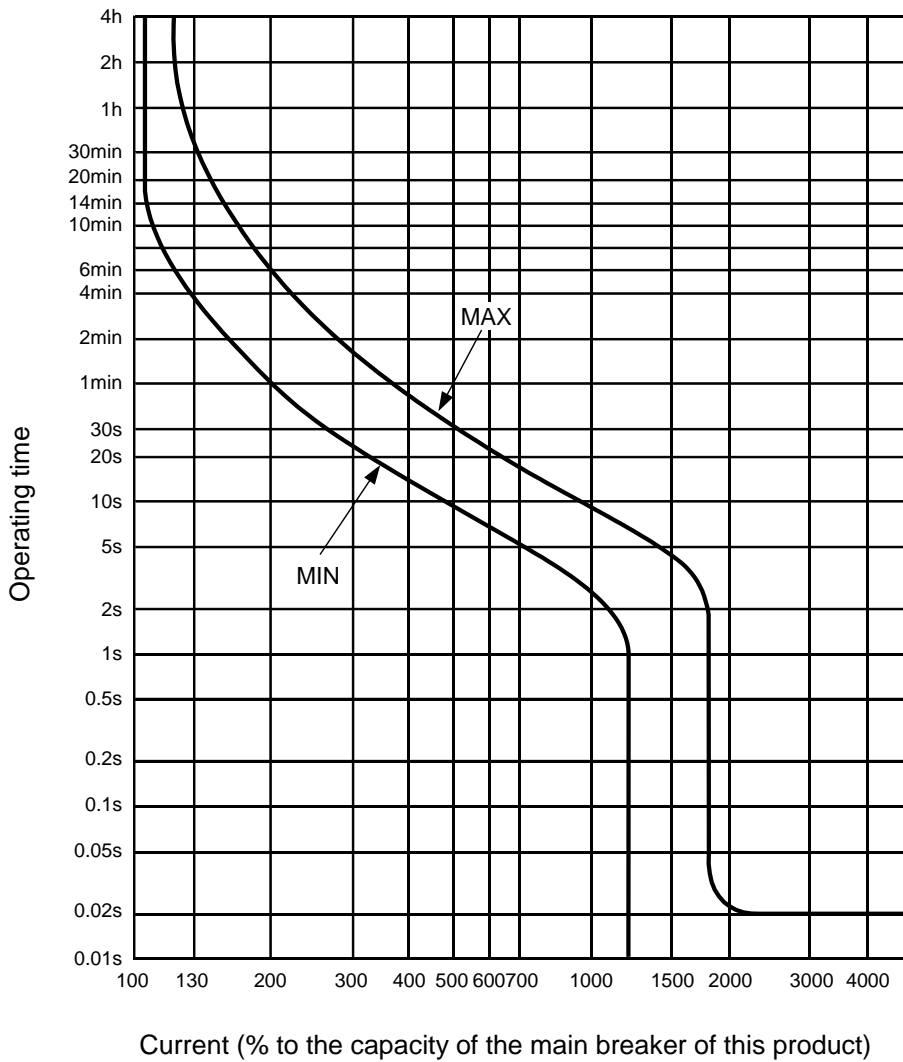

Figure 3-5 Breaker operating characteristics curve

3.3.4 Procedures for wiring installation

⚠ WARNING



Be sure to turn OFF the factory side (primary side) power before connection to the product.
Use the assigned procedure to perform lockout/tagout (Page 1-11).

1. Turn OFF the power breaker on customer side (primary side), and then use the assigned procedures to perform lockout/tagout.

[Tips]

Connection of the power cable with the product must be established first.
Do not connect the cable with the factory side at this point.

2. Turn OFF the main breaker of the product.
3. Undo the screws (2 pcs.) to open the front door.

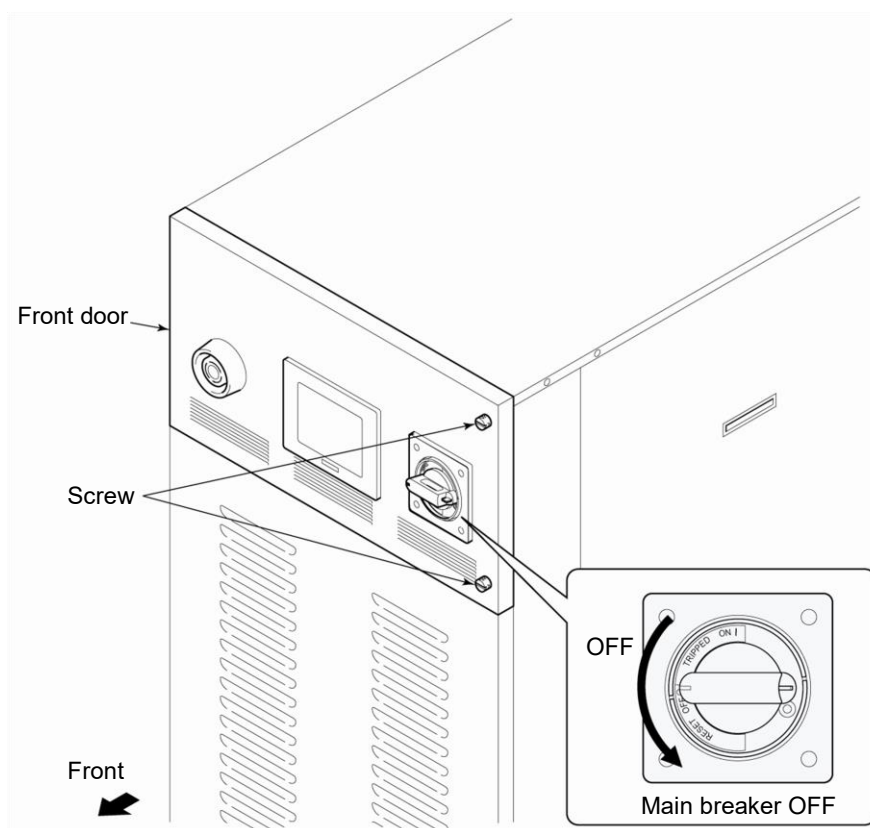

Figure 3-6 Main Breaker OFF

4. Undo the screws (2 pcs.) to remove the breaker cover.

Be sure to use a crosshead screwdriver.

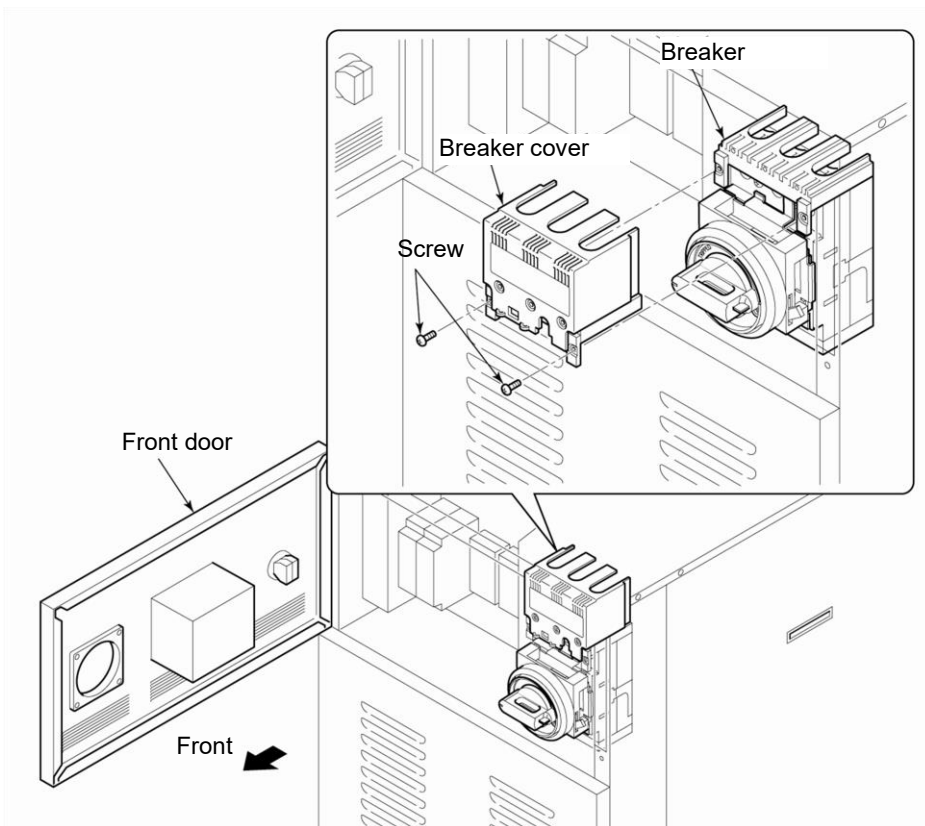

Figure 3-7 Removal of Breaker Cover

[Tips]

Make sure the breaker is at the 'OFF' position.
Otherwise, the opening of the front door is not possible.

5. Loosen the cap and insert the power cable from the power cable access. Retighten the cap after inserting the cable, and make sure the cable is secured.
-
6. In case of using serial communication, mount the ferrite core(accessory) to serial communication cable (1turn).
-
7. Connect the communication cables with P1, P2 and P3 as appropriate.
Fitting screw size: M2.6×0.45

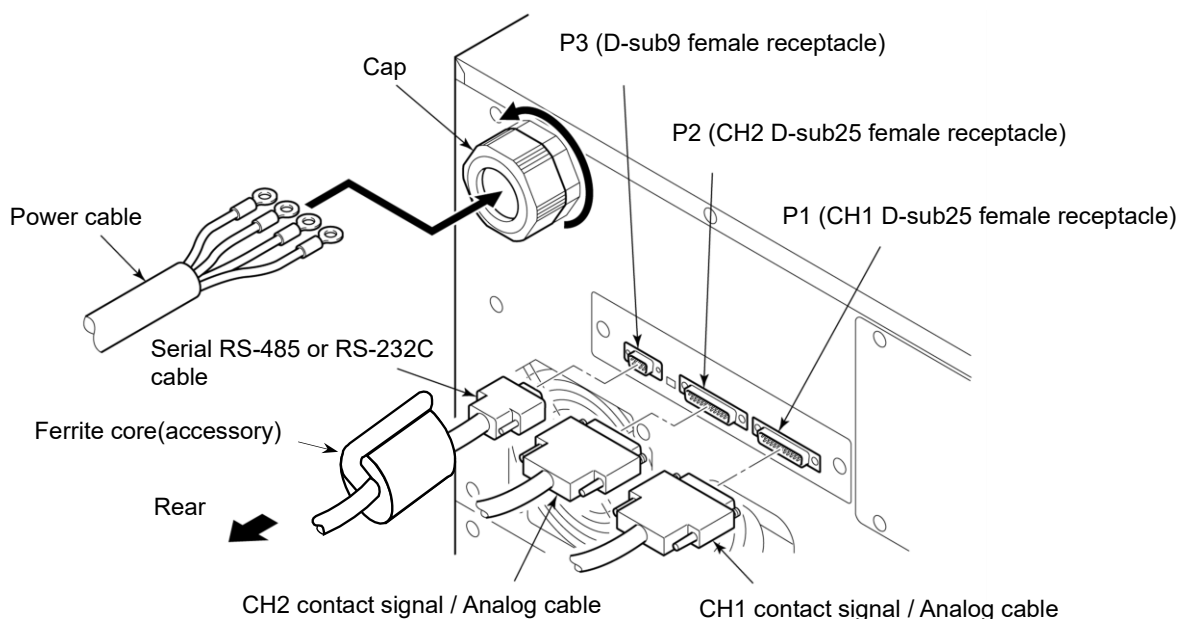

Figure 3-8 Power Cable Insertion and Communication Cable Connection

CAUTION



**Do not drop a screw or washer in the electrical unit when attaching the breaker cover and terminal.
Do not leave it in the product if dropped in. Potential failure may occur if the power is turned ON without removing it.**

[Tips]

See "Table 3-1 Power Cable and Main Breaker (The Product)" on page 3-7 for the recommended cable size and crimp contact.

8. Connect the power cables to the breaker terminal.

Be sure to use a crosshead screwdriver. Recommended torque: 6N•m

9. Connect the grounding terminal (M8) of the power cable to the earth bar.

Be sure to use a 13-mm open end wrench.

Recommended torque: 12.5 N•m

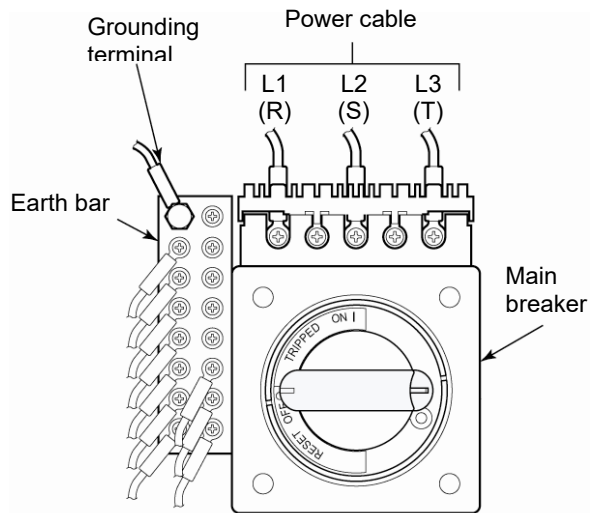

Figure 3-9 Connection of Power Cable and Grounding Terminal

[Tips]

See “Table 3-1 Power Cable and Main Breaker (The Product)” on page 3-7 for torque value.

10. Attach the breaker cover to the breaker.

11. Close the front door.

12. Connect the power cable to the power breaker on customer side (primary side).

CAUTION

 **Correct phase rotation is required when attaching the power cable to the breaker terminal.**

3.3.5 Installation of circulating fluid and facility water piping

⚠ CAUTION



- Choose proper external piping with consideration for pressure, temperature and compatibility with the circulating fluid. Potential pipe rupture during operation may occur if disregarded.
- Always insulate external circulating piping. Potential insufficient cooling performance due to heat absorption from the pipe surface and potential insufficient heating performance caused by thermal radiation if disregarded.
- Use clean pipes and pipe fittings, free of particles, oil and moisture. Apply air blow to the parts before using. The presence of particles, oil or moisture in the circulating fluid circuit can cause insufficient cooling, product failure attributed to moisture freezing, or foaming of the circulating fluid in the tank.
- The total capacity of circulating fluid required by external piping should remain under the capacity of the sub tank. Potential problem of tank overflow, when pump stop, may occur if disregarded. See “Appendix 8.1.1 Product specification” in Chapter 8 for the capacity of the sub tank.
- Be sure to choose a circulating fluid pipe capable of letting the fluid flow at rated flow rate or better. See “Pump performance” defined in “Appendix 8.1.1 Product specification” for the flow rate rating.
- Have a drip pan available in case of a fluid leak.
- Make sure of the locations of ports for the circulating fluid supply, return, facility water inlet, outlet and their corresponding connections are correct.
- Secure the piping connector section with a pipe wrench, and provide proper tightening torque to the pipe.
- Avoid physical shock when securing and tightening the connectors. Potential breakage and fluid leak may occur if disregarded.

■ Pipe diameter

Table 3-3 Pipe Diameter

Pipe	Diameter	Recommended torque (Material: SS* vs SS)
Facility water inlet	Rc1/2	28 to 30N•m (20.7 to 22.1ft-lbf)
Facility water outlet	Rc1/2	28 to 30N•m (20.7 to 22.1ft-lbf)
Circulating fluid supply	Rc3/4	28 to 30N•m (20.7 to 22.1ft-lbf)
Circulating fluid return	Rc3/4	28 to 30N•m (20.7 to 22.1ft-lbf)
Main tank drain port	Rc3/8 (with valve)	Piping not necessary
Sub tank drain port	Rc3/8 (with valve)	Piping not necessary
Drain pan port	Rc3/8	Piping not necessary

* SS: Stainless steel

■ **Procedure for piping installation**

Secure the pipe coupling section with a pipe wrench, and provide proper tightening to the pipe.

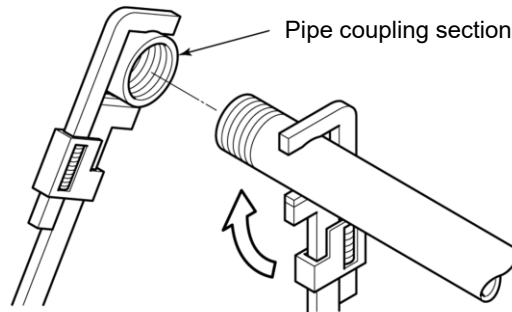

Figure 3-10 Pipe Tightening

■ **Recommended piping installation**

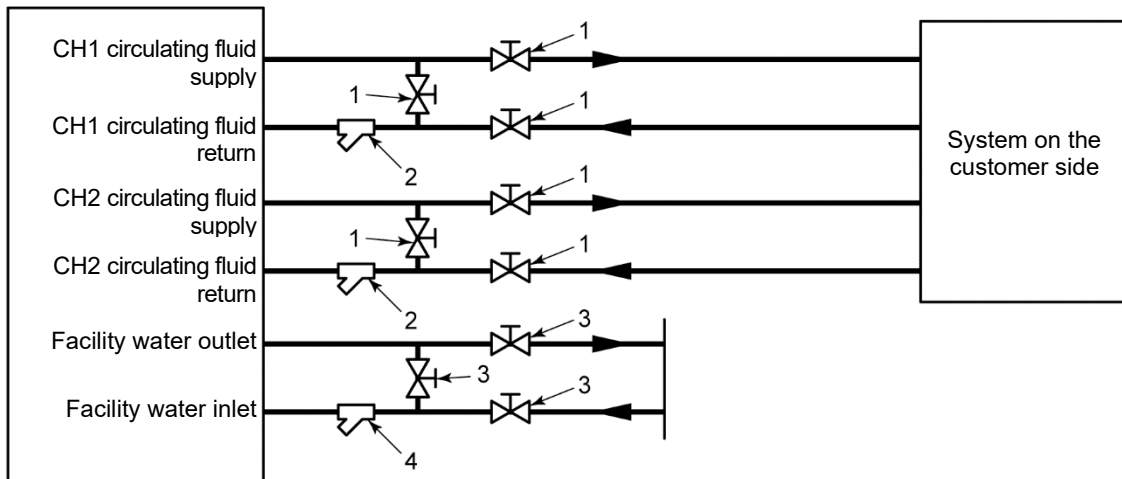

Figure 3-11 Recommended Piping Installation

Table 3-4 Recommended Pipe

No.	Name	Size	Material
1	Valve	Rc3/4	Stainless steel
2	Y-strainer (100μm)	Rc3/4	Stainless steel
3	Valve	Rc1/2	Stainless steel
4	Y-strainer (5μm)	Rc1/2	Stainless steel

Chapter 4 Product Startup and Shutdown

⚠ CAUTION



Only personnel, who have adequate knowledge of and experience with not only this product but associated equipment, are allowed to implement product startup and shutdown.

4.1 Pre-check

Check the following items prior to starting up the product.

4.1.1 Installation condition

- Make sure that the product is installed in a horizontal position.
- No heavy object is placed on the product. This product should not be applied with an undue force such as caused by piping installation.
- Re-check the items defined in “3.2 Installation” on page 3-3.

4.1.2 Cable connection

Make sure proper connection of the power cable, ground, and communication cables.

4.1.3 Installation of circulating fluid and facility water piping

Make sure that circulating fluid and facility water piping are installed properly.

4.1.4 Operating signal from your system

Make sure that no remote signal is being issued from your product. Product startup takes effect upon power-ON if the product receives a remote signal and it is in remote mode.

4.1.5 Check of emergency off [EMO] switch

Make sure of the location of the emergency off [EMO] switch before operating the product. See section 1.6.1 “Emergency off [EMO] switch” in Chapter 1 Safety Instructions on page 1-14 for details.

4.2 Opening of Facility Water Valve

CAUTION



Check that the facility water complies with not only the water quality standard defined in section 7.1 “Water Quality Management” on page 7-1 but the requirements provided in “8.1.1 Product specification” in Chapter 8 Appendix on page 8-1.

Open the facility water valve for water supply on your piping.

[Tips]

This product is fitted with a water regulating valve inside. Facility water may not flow upon product startup which is normal.

4.3 Filling of Circulating Fluid

CAUTION

 Circulating fluids to be used vary with system models. See section 8.1.1 “Product specification” in Chapter 8 Appendix on page 8-1 for the designated circulating fluid for a specific model.

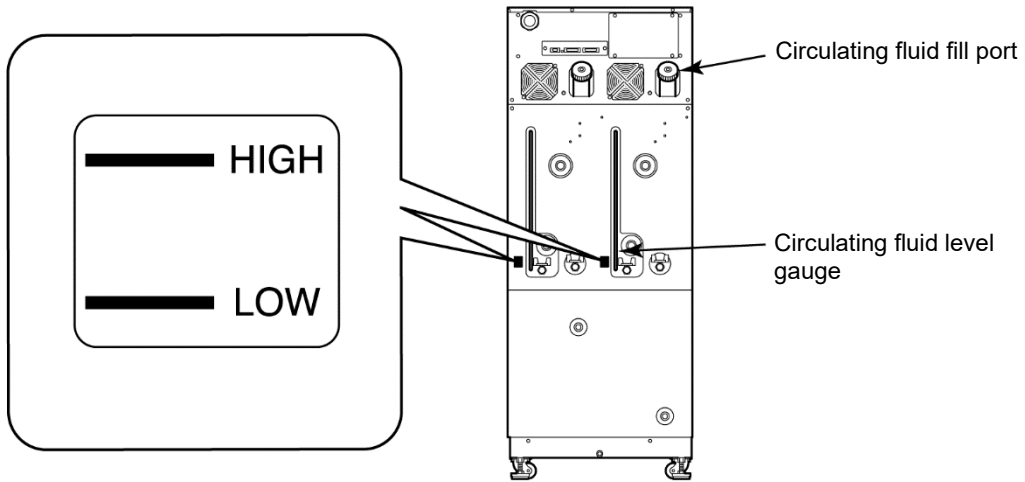



Figure 4-1 Circulating Fluid Fill Port and Circulating Fluid Level Gauge

4.3.1 Preparation of circulating fluid

■ When the circulating fluid is a fluorinated fluid

CAUTION

 Make sure of no oil, moisture, and other foreign materials contaminate the circulating fluid. Potential cooling error or product failure may occur if disregarded, due to contaminants freezing internally.

■ When the circulating fluid is a 60% ethylene glycol aqueous solution

Always check the concentration of the circulating fluid.

CAUTION

- Low concentration EG in the circulating fluid may cause system failure due to it being frozen in the system.
- High concentration EG in the circulating fluid may cause circulating pump overload, which triggers “Pump Breaker Trip FLT”.
- Potential cooling error may occur if the circulating fluid varies in concentration.

4.3.2 Filling of circulating fluid

Remove the circulating fluid fill cap, and fill the circulating fluid until it reaches its specified level.

The circulating fluid specified level is a range between “HIGH” and “LOW” in Figure 4-1.

Be sure to tighten the cap until it clicks after fluid supply.

If the circulating fluid is supplied over the specified level, follow the procedure provided in section 7.3.1 “Draining of circulating fluid out of tank” on page 7-4 to drain excess fluid until it reaches the specified level.

[Tips]

Level between “HIGH” and “LOW” represent liquid level in normal running condition. Immediately as you start filling up the product, the internal transferring pump start pumping fluid from the Sub Tank into the Main Tank. Thus the fluid level in the level gauge will start to drop.

During initial priming of the external piping, addition fluid is needed. See section 8.1.1 “Product specification” on page 8-1 for Sub Tank and Main Tank capacity.

WARNING



Circulating fluid must be filled to be in the range between “HIGH” and “LOW”. Potential overflow of hot circulating fluid may occur due to excessive volume.

Total fluid volume use to fill up the product including initial priming should not exceed combined volume of Sub Tank and Main Tank. If level is below the “LOW” mark, this product will trigger an alarm.

CAUTION



When filling the circulating fluid, make sure that the fluid inside the product has dropped to room temperature to prevent accidental burns.

CAUTION



To prevent moisture, which is formed by condensation of a flowed air, from finding its way into the tank, ensure the circulating fluid at room temperature when filling the fluid.

Be sure to tighten the cap until it clicks after fluid supply. Potential circulating fluid vaporization or moisture intrusion due to condensation of flowed air may occur if disregarded.

4.4 Requirement for Product Startup

4.4.1 Turning ON power

1. Make sure that the main breaker for the product is OFF, and release lockout/tagout of the power breaker on customer side (primary side). Then, turn ON the power.
2. Turn ON the main breaker of the product.

The “Initial screen” is displayed on the operation touch panel. The screen will change to the “Main screen” in approx. 30 seconds, and the product is ready to run.

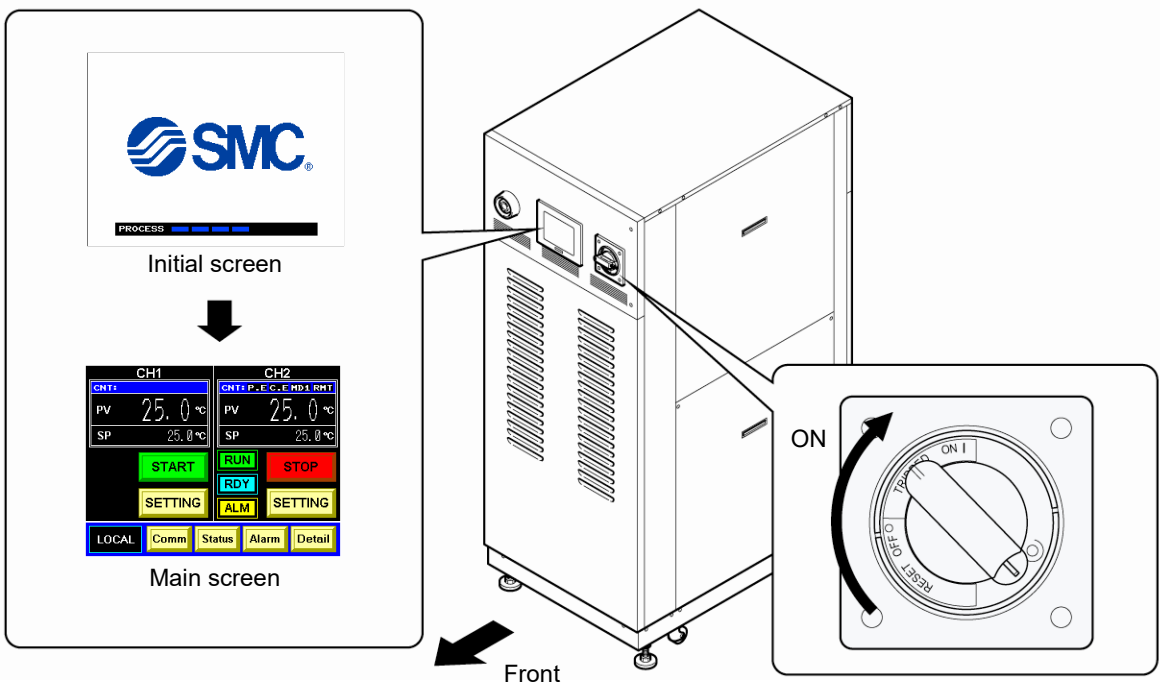

Figure 4-2 Main Breaker at 'ON'

⚠ WARNING



Press the emergency off [EMO] switch immediately upon occurrence of abnormal conditions. Be sure to turn OFF the main breaker afterwards.

4.4.2 Circulating fluid temperature setting

From the “Setting data screen” on the operation touch panel, set the circulating fluid at any temperature. See section 5.3.4 “CH1(2) setting data screen 1, 2” on page 5-7 for operating procedure.

[Tips]

See section 8.1.1 “Product specification” in “Chapter 8 Appendix” on page 8-1 for the setting range of circulating fluid temperature.

4.5 Product Startup and Shutdown

4.5.1 Product startup

Press the [START] key on the “Main screen” displayed on the operation touch panel.

The [RUN] lamp on the “Main screen” displayed on the operation touch panel comes on, which initiates product operation. “Special mode” may be displayed on the “Main screen” according to circumstances.

[Tips]

It is normal if “Special mode” is not displayed. See section 5.3.3 “Special mode” on page 5-6 for details.

4.5.2 Product shutdown

Press the [STOP] key on the “Main screen” displayed on the operation touch panel.

The “Special mode” is flashing on the operation touch panel. The compressor comes to a halt approx. 30 seconds after circulating pump stops for protection of the compressor. The screen is returned to the “Main screen”.

[Tips]

See section 5.3.3 “Special mode” on page 5-6 for details on special mode.

CAUTION



Internal equipment may remain at elevated or lowered in temperature immediately after product shutdown. Potential burns or frostbite may happen if your skin comes in contact with these surfaces. Further work is allowed only when the system reaches room temperature.

CAUTION



Emergency off [EMO] switch and main breaker (OFF) should not be used for product shutdown unless it is an emergency.

Chapter 5 Product Operation

5.1 Operation Touch Panel

Use the operation touch panel located in front of the product for the basic operations.

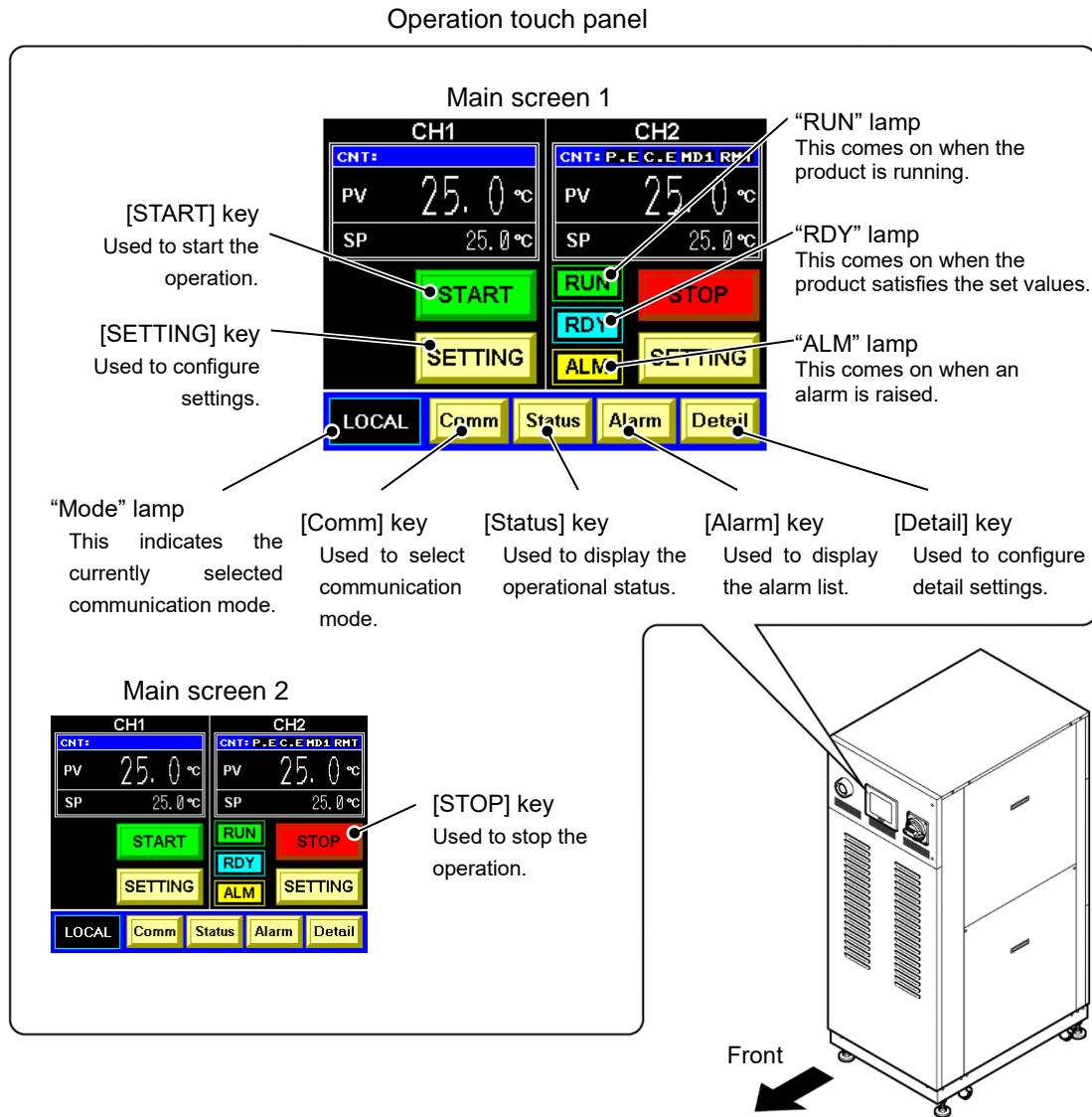

Figure 5-1 Operation Touch Panel

CAUTION

Be sure to use your fingers only to operate the operation touch panel. Using sharp object will damage the panel.

5.2 Flow Chart of Operation Screen

5.2.1 Flow Chart of Operation Screen (1)

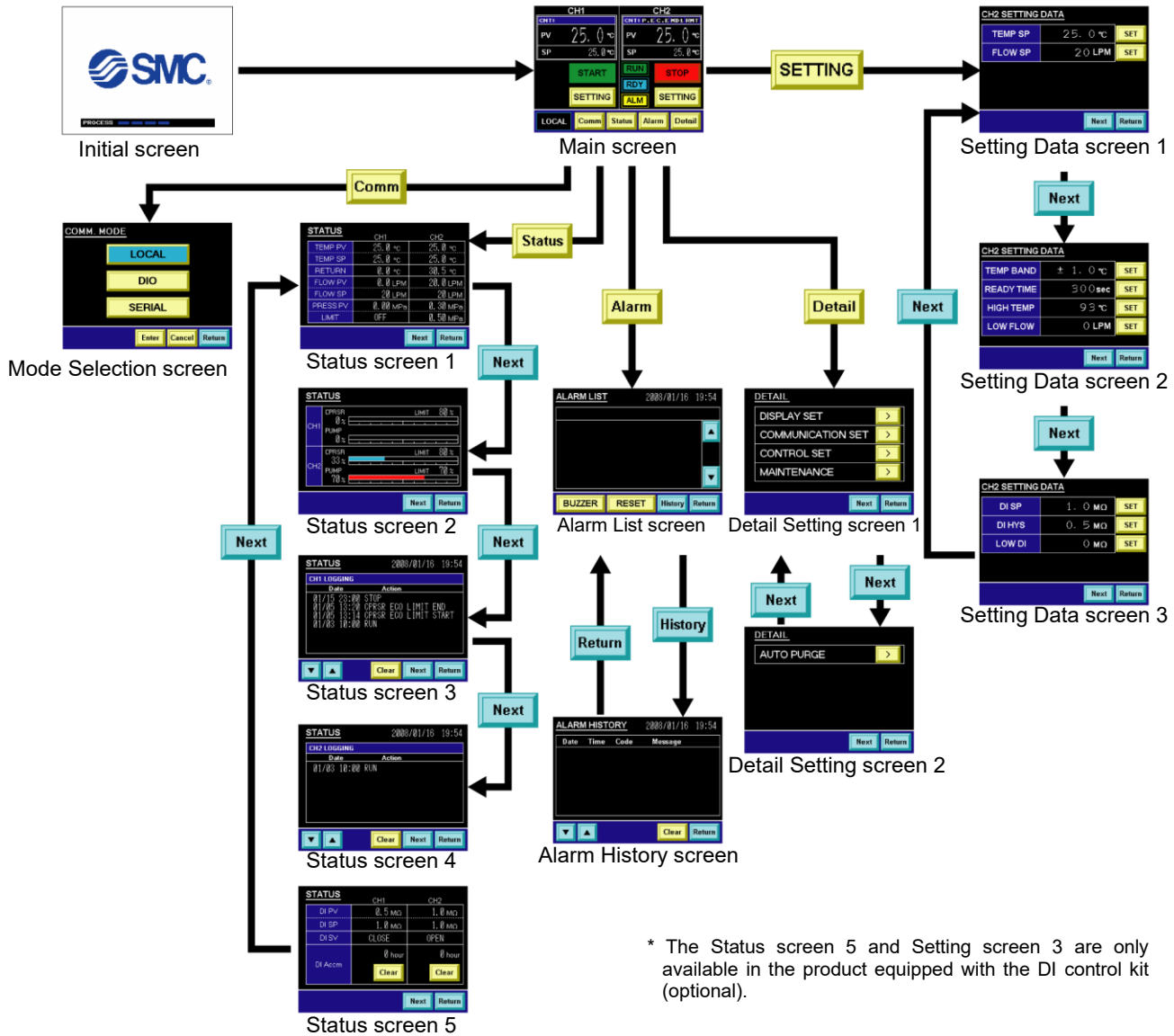
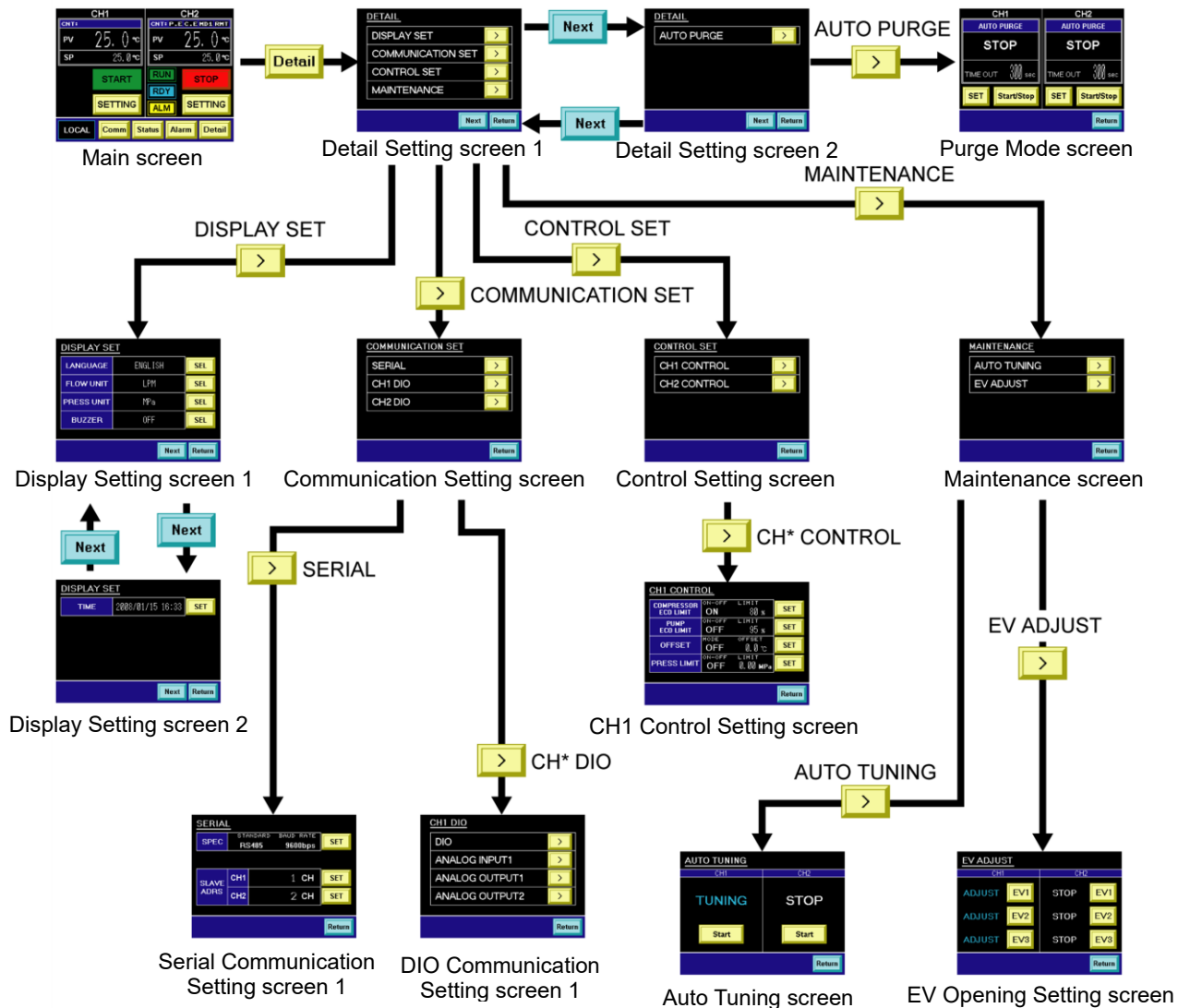

Figure 5-2 Flow Chart of Operation Screen (1)

Table 5-1 Descriptions of Operation Screens (1)

Screen	Descriptions	Reference
Initial screen	Displays the status of data read, memory check, and initialization.	Page 5-4
Main screen	Allows setting screen selection.	Page 5-5
CH1(2) Setting Data screen 1, 2, 3	Allows the setting of set values of CH1(2).	Page 5-7
Mode Selection screen	Allows communication mode selection.	Page 5-11
Status screen 1, 2, 3, 4, 5	Displays the operating condition of the product.	Page 5-14
Alarm List screen	Lists alarms currently raised in the product. This screen automatically appears in the event of an alarm.	Page 5-19
Alarm History screen	Displays the list of alarms that have been raised in the product.	Page 5-20
Detail Setting screen 1, 2	Allows selection of a detail setting item. See section 5.2.2 "Flow Chart of Operation Screen (2)" for the flow chart of the Detail Setting screens.	Page 5-22

5.2.2 Flow Chart of Operation Screen (2)



* The Detail Setting screen 2 and Purge mode screen are only available in the product equipped with the Automatic circulating fluid collector (optional).

Figure 5-3 Flow Chart of Operation Screen (2)

Table 5-2 Descriptions of Operation Screens (2)

Screen	Descriptions	Reference
Display Setting screen 1	Allows the changing of the language for messages that are displayed on the operation touch panel and the units of flow rate and pressure.	Page 5-24
Display Setting screen 2	Allows time setting for this product.	Page 5-25
Communication Setting screen	Allows detail setting for communication specifications.	Page 5-27
Serial Communication Setting screen	Allows detail setting for serial communication specifications.	Page 5-28
CH1(2)DIO Communication Setting screen	Allows detail setting for DIO (analog) communication specifications.	Page 5-32
Control Setting screen	Allows access to the CH1 and CH2 Control Setting screens.	Page 5-44
CH1(2) Control Setting screen	Allows the setting of compressor and pump ECO limits, offset, and circulating fluid outlet pressure upper limit.	Page 5-44
Maintenance screen	Allows access to the electron expansion valve adjustment screen. Not allowed to use during normal operation.	Page 5-49
Auto Tuning screen	Allows auto tuning of the electron expansion valve. Not allowed to use during normal operation.	Page 5-50
EV Opening Setting screen	Allows opening adjustment of the electron expansion valve. Not allowed to use during normal operation.	Page 5-51
Purge Mode screen	Allows the use of the circulating fluid automatic collection function (optional).	Page 5-52

5.3 Operation Screen

5.3.1 Initial screen



Figure 5-4 “Initial Screen”

The “Initial screen” is displayed upon power-ON of this product.
This screen remains ON for approx. 30 seconds and is automatically switched to the “Main screen”.
The “Alarm screen” is displayed if error occurs in the product.

Table 5-3 “Initial Screen”

No.	Item	Descriptions
1	PROCESS	Status of data read and memory check

5.3.2 Main screen

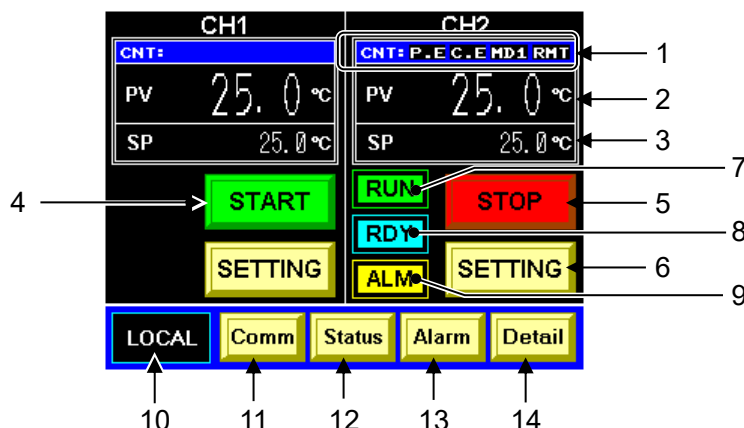



Figure 5-5 "Main Screen"

Table 5-4 "Main Screen"

No.	Item	Descriptions	
1	CNT:	P.E	Pump ECO limit : Be available
		C.E	Compressor ECO limit : Be available
		MD1	Offset mode 1
		RMT	Remote
2	PV	Discharge temperature of the circulating fluid (A value derived according to the offset*1 if applied)	
3	SP	Set discharge temperature of the circulating fluid	
4	[START] key	Used to start product operation.	The following "MESSAGE screen" is displayed when the product is ready to run. 
			The following "MESSAGE screen" is displayed when the product is not ready to run. 
			} Reasons of inoperative status
5	[STOP] key	Used to start product operation.	
6	[SETTING] key	Used to display the "CH1(2) setting data screen 1, 2" on page 5-7.	
7	RUN lamp	This remains on during product operation.	
8	RDY lamp	This comes on when the product satisfies the conditions of the BAND/READY function*2.	
9	ALM lamp	This comes on when an alarm is raised.	
10	LOCAL	The currently selected communication mode. Factory default: LOCAL	
11	[Comm] key	Used to display the "Mode selection screen" on page 5-11.	
12	[Status] key	Used to display the "Status screen 1" on page 5-14.	
13	[Alarm] key	Used to display the "Alarm list screen" on page 5-19.	
14	[Detail] key	Used to display the "Detail setting screen 1" on page 5-22.	

[Tips]

*1: See "8.4 Offset Function" in Chapter 8 Appendix on page 8-14 for offset features (*1).

*2: See "8.5 BAND/READY Function" in Chapter 8 Appendix on page 8-17 for the BAND/READY function.

5.3.3 Special mode

The indicator lamp is designed to flash when the product goes into special mode, as shown below.

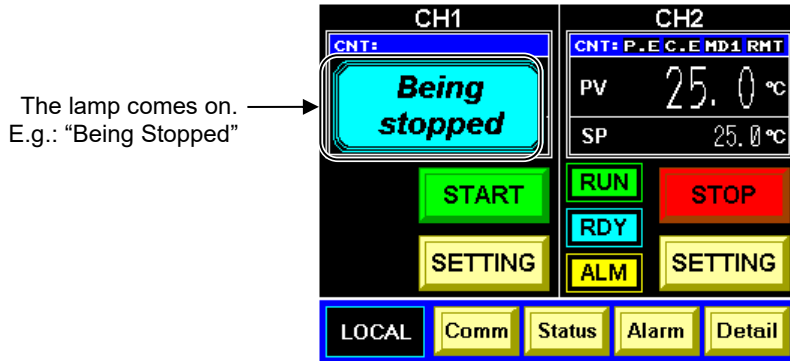

Figure 5-6 "Main Screen"

Table 5-5 Special Mode

Indicator lamp	Mode	Descriptions
Pump up	Pump up	Your piping is supplied with an insufficient amount of the circulating fluid at product startup, and it is supplied with circulating fluid from the chiller.
Being stopped	Being Stopped	The product is at halt, or the compressor is ready to stop (for approx. 30 sec).
Purging	Purging	Circulating fluid is being recovered from piping in your system with the utilization of the circulating fluid automatic collection function.
Internal Pump up	Internal Pump up	Circulating fluid is being internally pumped to the main tank from the sub tank. Product operation is disabled if this message is displayed.
Compressor ECO Limit	Compressor ECO Limit	The limiter is triggered, which limits the performance of the compressor. See sections "5.3.27 CH1(2) Compressor ECO Limit setting screen" on page 5-45 for setting.
Pump ECO Limit	Pump ECO Limit	The limiter is triggered, which limits the performance of the pump. See sections "5.3.28 CH1(2) Pump ECO Limit setting screen" on page 5-46 for setting.

5.3.4 CH1(2) setting data screen 1, 2

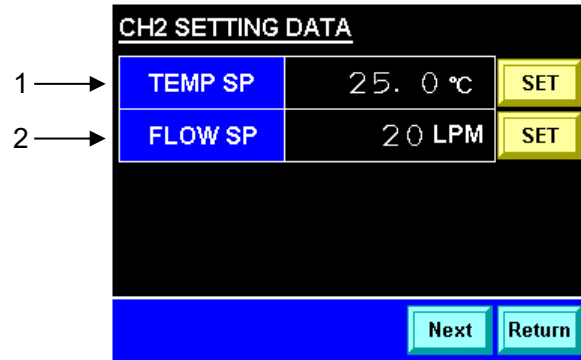

Figure 5-7 “CH1(2) Setting Data Screen 1”

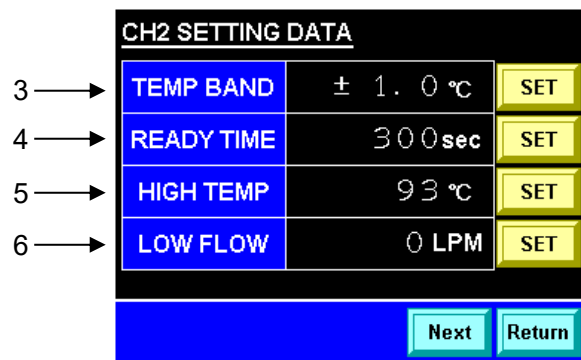

Figure 5-8 “CH1(2) Setting Data Screen 2”

Table 5-6 “CH1(2) Setting Data Screen 1, 2”

No.	Item	Descriptions	Factory default
1	TEMP SP	Allows the setting of circulating fluid discharge temperature in 0.1°C increments.	20°C
2	FLOW SP	Allows the setting of circulating fluid discharge flow rate in 1L/min increments.	20LPM
3	TEMP BAND ^{*1}	Allows the selection of the band width for TEMP SP in 0.1°C increments.	1.0°C
4	READY TIME	Allows the setting of time from when TEMP PV reaches the band range to when [RDY] is displayed on the Main screen or Ready signal is output, by second.	300 sec
5	HIGH TEMP	Allows the setting of a temperature that causes “Reservoir High Temp WRN” alarm, in 1°C increments. An alarm is raised when circulating fluid temperature exceeds the set temperature.	93°C
6	LOW FLOW	“Discharge Low Flow WRN” alarm is raised when FLOW PV falls below the set flow rate. The flow rate setting is allowed in 1L/min increments. Alarm is disabled if the selection is “0”.	10LPM
—	[SET] key	Used to display the “Ten-key screen” on page 5-9, which allows numerical input and setting.	—
—	[Next] key	The CH1(2) setting data screen 1, 2 are alternately displayed. The “CH1(2) setting data screen 3” on page 5-8 is also displayed if the optional DI control kit is provided.	—
—	[Return] key	Used to display the “Main screen” on page 5-5.	—

[Tips]

The setting range of items is displayed on the “Ten-key screen” with the touch of the [SET] key.

*1: See “8.5 BAND/READY Function” in Chapter 8Appendix on page 8-17 for the TEMP BAND.

5.3.5 CH1(2) setting data screen 3

CAUTION

The “CH1(2) setting data screen 3” is displayed only if the DI control kit (optional) is provided.

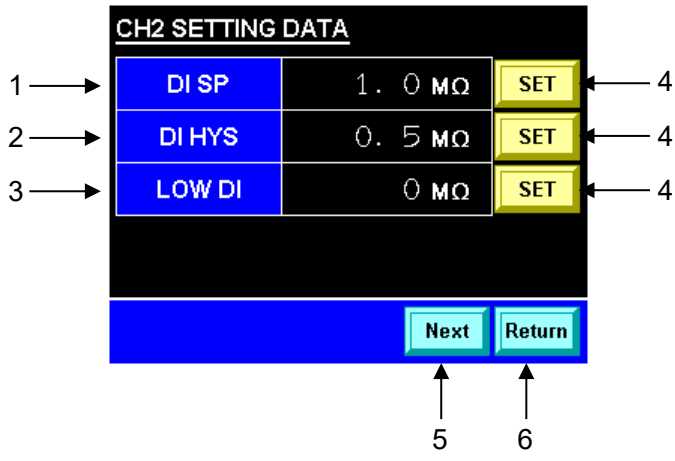

Figure 5-9 “CH1(2) Setting Data Screen 3”

Table 5-7 “CH1(2) Setting Data Screen 3”

No.	Item	Descriptions	Factory default
1	DI SP	Allows the setting of SP of the circulating fluid electric resistance with the touch of the [SET] key.	1.0MΩ
2	DI HYS	Allows the setting of HYS of the circulating fluid electric resistance with the touch of the [SET] key.	0.5 MΩ
3	LOW DI	Allows the setting of the lower limit of the circulating fluid electric resistance with the touch of the [SET] key.	0.0 MΩ
4	[SET] key	Used to display the “Ten-key screen”.	—
5	[Next] key	Used to display the “CH1(2) setting data screen 1, 2” on page 5-7.	—
6	[Return] key	Used to display the “Main screen” on page 5-5.	—

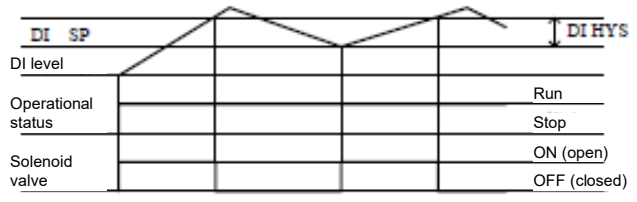

Figure 5-10 DI HYS

[Tips]

The setting range of items appears on the “Ten-key screen” with the touch of the [SET] key.

Ten-key screen

The “Ten-key screen” appears with the touch of the [SET] key of each item on the CH1(2) Setting screens 1, 2, and 3, which enables the setting of set values.

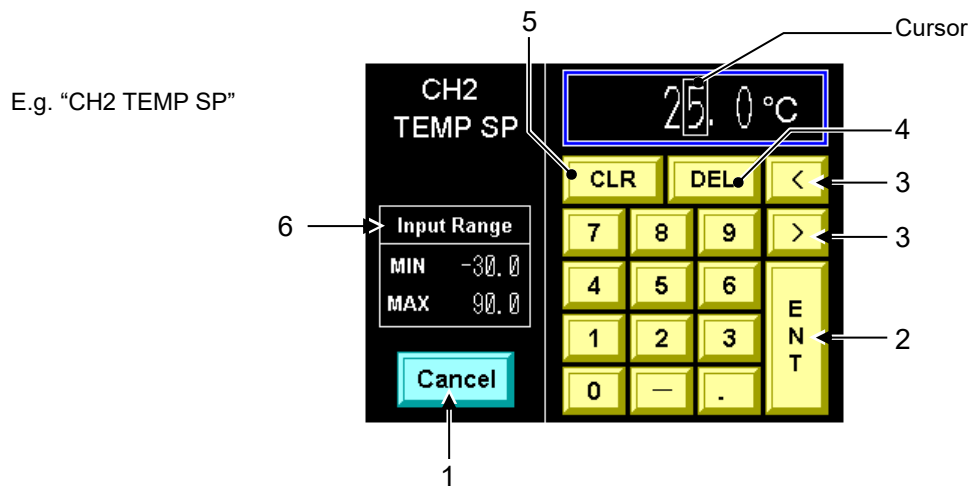

Figure 5-11 “Ten-key Screen”

Table 5-8 “Ten-key Screen”

No.	Item	Descriptions
1	[Cancel] key	Used to cancel changes and return to the Setting Data screen.
2	[ENT] key	Used to confirm your entry and return to the previous screen.
3	[<], [>] key	Used to move the cursor.
4	[DEL] key	Used to delete a number on which the cursor is put. (“0” is displayed when deleted)
5	[CLR] key	Used to clear a value. (The value is reset to zero.)
6	Input Range	Allowable range for value input

■ **Procedure for changing circulating fluid set temperature**

1. Touch the [SETTING] key in “CH2” on the “Main screen”.
 The “CH2 Setting Data screen 1” is displayed.

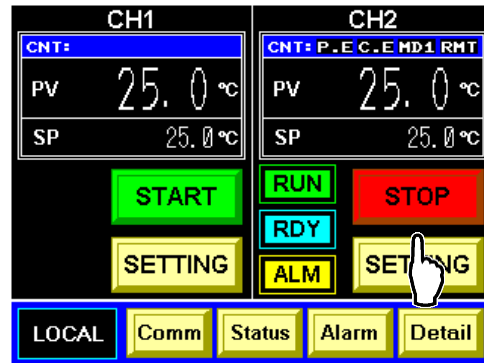

Figure 5-12 “Main Screen”

2. Touch the [SET] key for “TEMP SP”.
 The “Ten-key screen” is displayed.

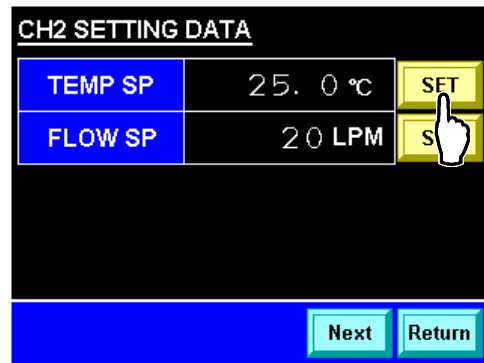

Figure 5-13 “CH2 Setting Data Screen 1”

3. Use the ten-key to input a set value, and touch the [ENT] key.
 The setting of the TEMP SP set value takes place, and the “CH2 Setting Data screen 1” is displayed.

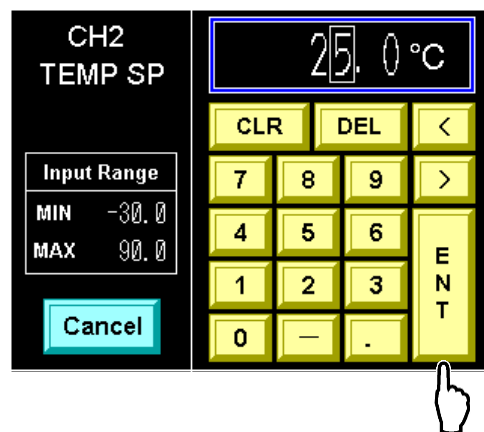

Figure 5-14 “Ten-key Screen”

5.3.6 Mode selection screen

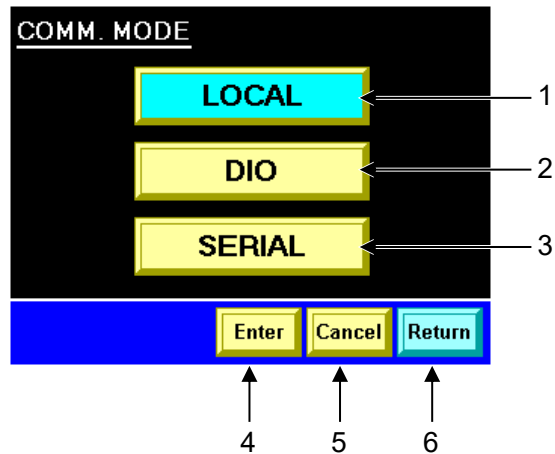

Figure 5-15 “Mode Selection Screen”

This screen enables the selection of the communication mode. The procedures for product start/stop and set value setting may vary with the communication mode.

CAUTION

Please note that the product starts running when the communication mode is selected if the run signal is input by an external communication.

Table 5-9 “Mode Selection Screen”

No.	Item	Descriptions
1	LOCAL	Product start/stop is available only from the operation touch panel.
2	DIO	Product start/stop is allowed only through analog communication and contact signal.
3	SERIAL	Product start/stop is available only through serial RS-485 communication.
4	[Enter] key	Used to display the “MESSAGE screen” to determine the selected communication mode.
5	[Cancel] key	Used to cancel the selection.
6	[Return] key	Used to display the “Main screen” on page 5-5.

[Tips]

The mode is factory-configured to [LOCAL]. See section 5.3.18 “Communication setting screen” on page 5-27 on communication setting.

■ Procedure for changing communication mode

1. Touch the [Comm] key on the “Main screen”.
The “Mode Selection screen” is displayed.

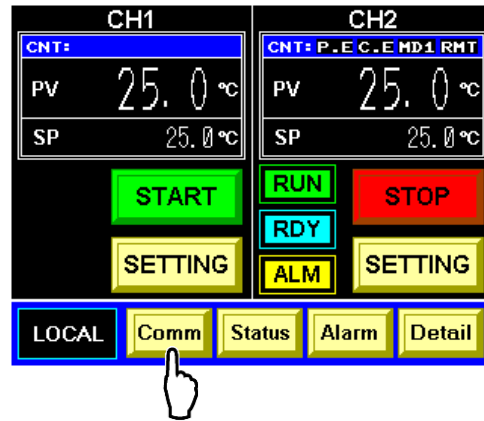

Figure 5-16 “Main Screen”

2. Touch “SERIAL” on the “Mode Selection screen”.
The name of “SERIAL” flashes.

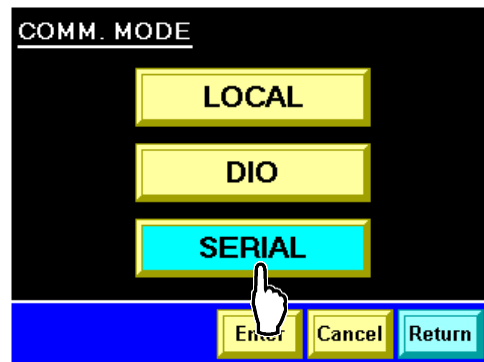

Figure 5-17 “Mode Selection screen”

[Tips]

Mode selection has not taken place while the name of “SERIAL” is flashing.

3. Touch the [Enter] key.
The “MESSAGE screen” is displayed.

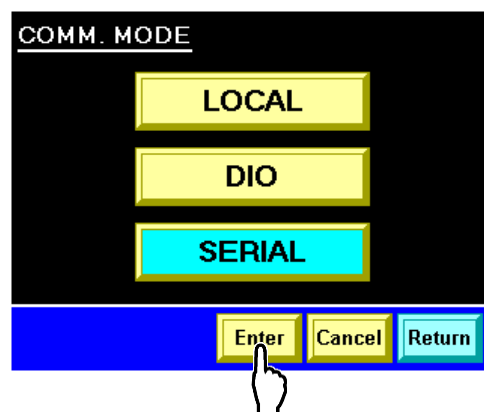

Figure 5-18 “Mode Selection screen”

[Tips]

With the touch of the [Cancel] key, the screen is switched to the “Mode Selection screen” where “LOCAL” is selected.

4. Touch the [YES] key.

The “SERIAL” mode is established, instead of “LOCAL”, and the “Main screen” is displayed accordingly.



Figure 5-19 “MESSAGE Screen”

[Tips]

With the touch of the [NO] key, the screen is switched to the “Mode Selection screen” where the name of “SERIAL” is flashing.

5.3.7 Status screen 1

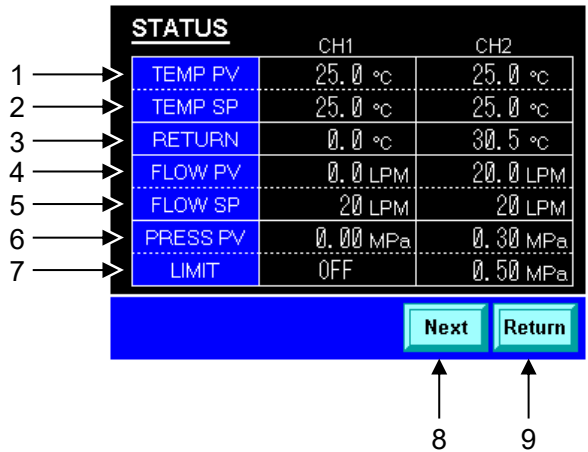

Figure 5-20 "Status Screen 1"

Table 5-10 "Status Screen 1"

No.	Item	Descriptions
1	TEMP PV	Discharge temperature of the circulating fluid (A value derived according to the offset ^{*1} if applied)
2	TEMP SP	Set circulating fluid discharge temperature
3	RETURN	Return temperature of the circulating fluid
4	FLOW PV	Discharge flow rate of the circulating fluid When using the by-pass piping set, a flow becomes a total of flow on customer side and flow on by-pass.
5	FLOW SP	Set circulating fluid discharge flow rate
6	PRESS PV	Discharge pressure of the circulating fluid
7	LIMIT	Limiting value of circulating fluid discharge pressure "OFF" is shown if no limits are imposed. See section "5.3.30 CH1(2) circulating fluid discharge pressure limit setting screen" on page 5-48 for limit setting.
8	[Next] key	Used to display the "Status screen 2" on page 5-15.
9	[Return] key	Used to display the "Main screen" on page 5-5..

[Tips]

*1: See "8.4 Offset Function" in Chapter 8 Appendix on page 8-14 on offset features.

5.3.8 Status screen 2

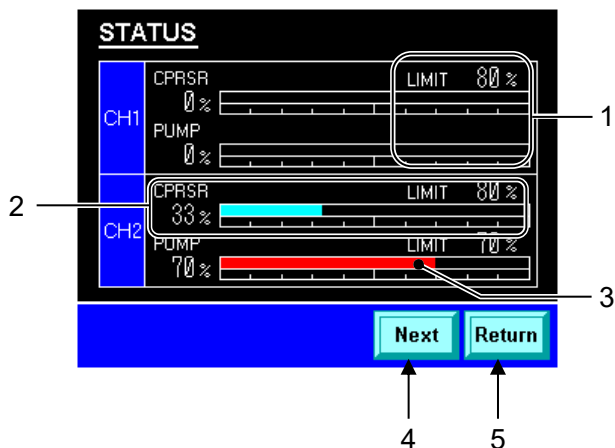

Figure 5-21 "Status Screen 2"

Table 5-11 "Status Screen 2"

No.	Item	Descriptions
1	-	Limiting value for the compressor and pump with limited abilities (ON is selected on the setting screen) <E.g.> Settings on the above screen CH1 CPRSR ECO LIMIT: ON CH1 PUMP ECO LIMIT: OFF See sections "5.3.27 CH1(2) Compressor ECO Limit setting screen" on page 5-45 and "5.3.28 CH1(2) Pump ECO Limit setting screen" on page 5-46 for setting.
2	-	Output and numerical value presented in bar graph form
3	-	The indicator turns red when output is limited with the limiter.
4	[Next] key	Used to display the "Status screen 3, 4" on page 5-16.
5	[Return] key	Used to display the "Main screen" on page 5-5.

5.3.9 Status screen 3, 4

The “Status screen 3” and “Status screen 4” enable the recording of the operational status of CH1 and CH2 respectively.

The explanation proceeds taking the “Status screen 3” as an example (The “Status screen 3” is taken as an example for explanation?). The functions also apply to the “Status screen 4” .



Figure 5-22 “Status Screen 3”

Table 5-12 “Status Screen 3”

No.	Item	Descriptions	
1	Logging data	Date and time of operation listed below are recorded and displayed.	
		RUN	Operation start
		STOP	Operation stop
		CPRSR ECO LIMIT START	Compressor ECO limiter start
		CPRSR ECO LIMIT END	Compressor ECO limiter stop
		PUMP ECO LIMIT START	Pump ECO limiter start
		PUMP ECO LIMIT END	Pump ECO limiter stop
		PRESS LIMIT START	Pressure limiter start
	PRESS LIMIT END	Pressure limiter stop	
2	[▲][▼] key	Used to scroll through the logging data.	
3	[Clear] key	Used to display the “MESSAGE screen” to delete the logging data.	
4	[Next] key	Used to display the “Status screen 1” on page 5-14. The “Status screen 5” on page 5-18 is displayed with the touch of this key if the optional DI control kit is provided.	
5	[Return] key	Used to display the “Main screen” on page 5-5.	

[Tips]

Data recording stores up to 128 pieces of logging data. If there are 128 or more pieces of data, the logging data is to be deleted in order of longest stored.

■ Procedure for deleting logging data

1. Touch the [Clear] key.

The “MESSAGE screen” is displayed.

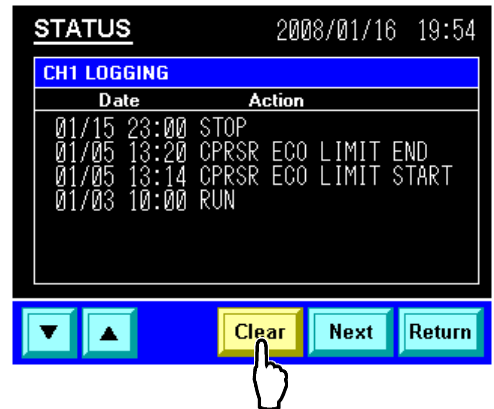

Figure 5-23 “Status Screen 3”

2. Touch the [YES] key.

Logging data deletion takes place as to data displayed on the “Status screen 3”.



Figure 5-24 “MESSAGE Screen”

[Tips]

Logging data deletion is not performed when the [NO] key is touched, which causes the “Status screen 3” to be displayed.

5.3.10 Status screen 5

CAUTION

The “Status screen 5” is displayed only if the DI control kit (optional) is provided.

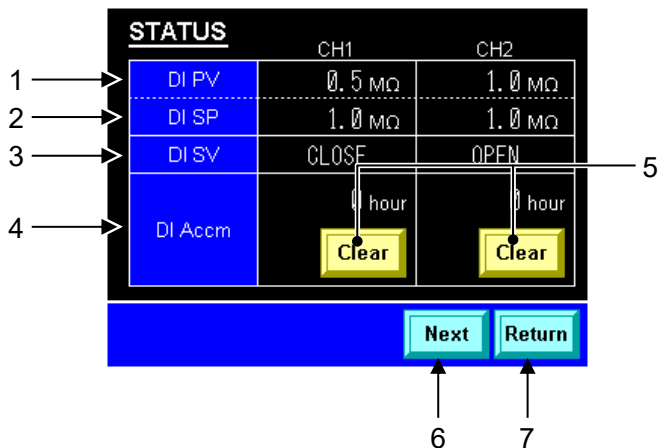

Figure 5-25 “Status Screen 5”

Table 5-13 “Status Screen 5”

No.	Item	Descriptions
1	DI PV	DI level of the circulating fluid
2	DI SP	Set DI level
3	DI SV	Status of the DI solenoid valve (OPEN/CLOSE)
4	DI Accm	Accumulated time that the solenoid valve is activated (ON) (Accumulated DI filter flow time)
5	[Clear] key	Used to display the “MESSAGE screen” to delete DI Accm.
6	[Next] key	Used to display the “Status screen 1” on page 5-14.
7	[Return] key	Used to display the “Main screen” on page 5-5.

5.3.11 Alarm list screen

In the event of an error in the product, the alarm buzzer sounds*1 and the current screen is switched to the “Alarm List screen”.

The alarm lamp on the “Alarm List screen” flashes, and the relevant alarm code and message are displayed.

See section 6.2 “Troubleshooting” in “Chapter 6 Error Message and Troubleshooting” for alarm numbers and messages.

[Tips]

*1: The alarm buzzer is activated when it is ON in settings on the “Display setting screen 1” on page 5-24.

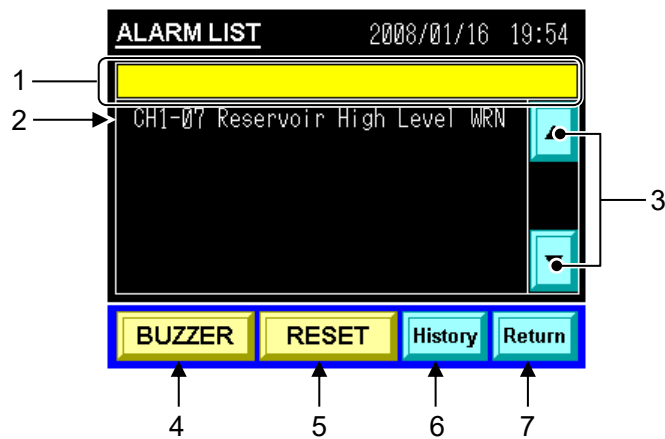
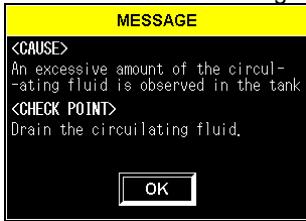

Figure 5-26 “Alarm List Screen”

Table 5-14 “Alarm List Screen”

No.	Item	Descriptions
1	Alarm lamp	This flashes in the event of an error in the product.
2	Alarm message	Alarm code and message The “MESSAGE screen” stating pertinent troubleshooting advice is displayed with the touch of the alarm message. 
3	[▲][▼] key	Used to scroll through the alarm list.
4	[BUZZER] key	Used to cause the alarm lamp to stop flashing and stop the buzzer.
5	[RESET] key	With the error cause eliminated, the alarm message turns off with the touch of the [RESET] key.
6	[History] key	Used to display the “Alarm history screen” on page 5-20.
7	[Return] key	Used to display the “Main screen” on page 5-5.

5.3.12 Alarm history screen

The Alarm History screen lists alarms that have been raised in the product (alarm occurrence date, alarm code, and alarm message).

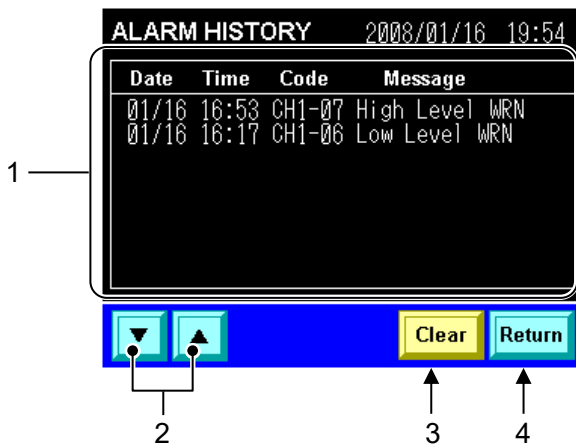

Figure 5-27 "Alarm History Screen"

Table 5-15 "Alarm History Screen"

No.	Item	Descriptions
1	Alarm history	Date and time of an alarm occurrence, alarm code, and alarm message
2	[▲][▼] key	Used to scroll through the alarm history data.
3	[Clear] key	Used to display the "MESSAGE screen" to delete the alarm history data.
4	[Return] key	Used to display the "Alarm list screen" on page 5-19.

[Tips]

Data recording stores up to 128 pieces of alarm history data. If there are 128 or more pieces of data, the alarm history data is to be deleted in order of longest stored.

■ Procedure for deleting alarm history data

1. Touch the [Clear] key.

The “MESSAGE screen” is displayed.

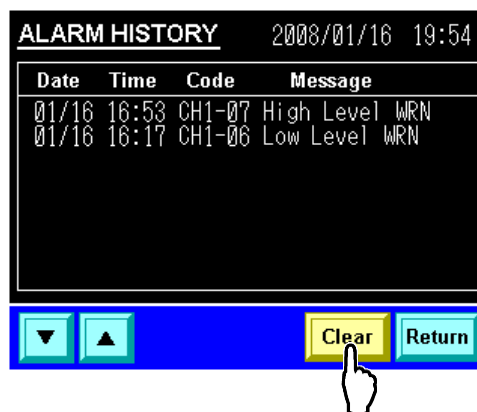

Figure 5-28 “Alarm History Screen”

2. Touch the [YES] key.

Alarm history data deletion takes place.



Figure 5-29 “MESSAGE Screen”

[Tips]

Alarm history data deletion is not performed when the [NO] key is touched, which causes the “Alarm History screen” to be displayed.

5.3.13 Detail setting screen 1

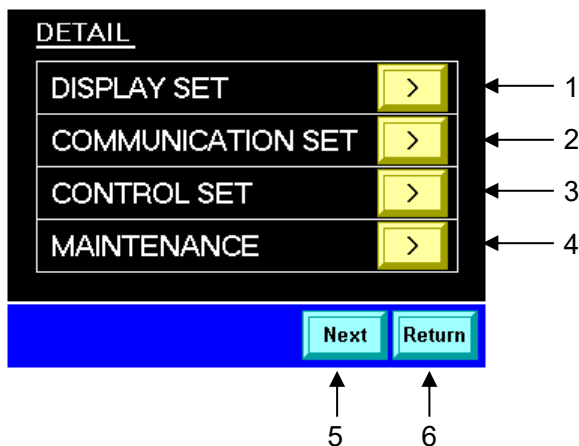

Figure 5-30 "Detail Setting Screen 1"

Table 5-16 "Detail Setting Screen 1"

No.	Item	Descriptions
1	DISPLAY SET	Used to display the "Display setting screen 1" on page 5-24.
2	COMMUNICATION SET	Used to display the "Communication setting screen" on page 5-27.
3	CONTROL SET	Used to display the "Control setting screen" on page 5-44.
4	MAINTENANCE	Used to display the "Maintenance screen" on page 5-49.
5	[Next] key	Used to display the "Detail setting screen 2" on page 5-23.
6	[Return] key	Used to display the "Main screen" on page 5-5.

5.3.14 Detail setting screen 2

CAUTION

The “Detail setting screen 2” is displayed only if the Automatic circulating fluid collector (optional) is provided.

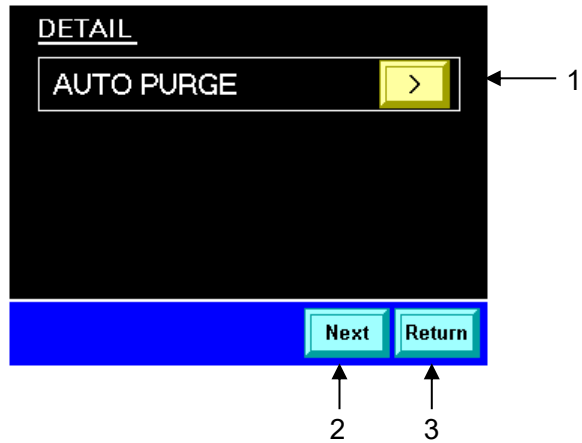

Figure 5-31 “Detail Setting Screen 2”

Table 5-17 “Detail Setting Screen 2”

No.	Item	Descriptions
1	AUTO PURGE	Used to display the “Purge mode screen” on page 5-52.
2	[Next] key	Used to display the “Detail setting screen 1” on page 5-22.
3	[Return] key	Used to display the “Main screen” on page 5-5.

5.3.15 Display setting screen 1

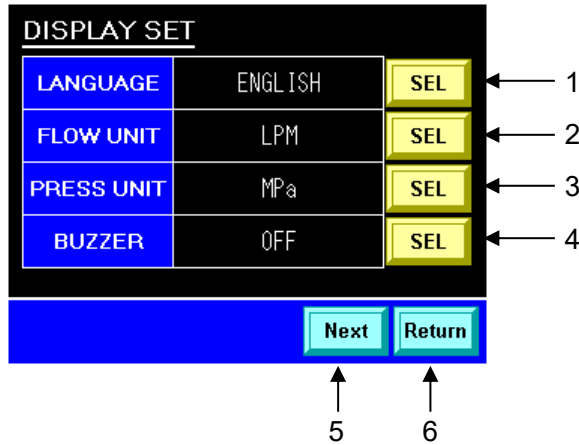

Figure 5-32 “Display Setting Screen 1”

Table 5-18 “Display Setting Screen 1”

No.	Item	Setting range	Descriptions	Factory default
1	LANGUAGE	ENGLISH, JAPANESE, KOREAN	<p>Allows the selection of a language for the “MESSAGE screen”. Use the [SEL] key to select a language and accept the selection.</p>	ENGLISH
2	FLOW UNIT	LPM, GPM	<p>Allows the selection of the unit of flow rate. Use the [SEL] key to select a language and accept the selection.</p>	LPM
3	PRESS UNIT	MPa, PSI	<p>Allows the selection of the unit of pressure. Use the [SEL] key to select a language and accept the selection.</p>	MPa
4	BUZZER	ON, OFF	<p>Allows the setting of the alarm buzzer, “ON” or “OFF”. Use the [SEL] key to select a language and accept the selection.</p>	ON
5	[Next] key	—	Used to display the “Display setting screen 2” on page 5-25.	—
6	[Return] key	—	Used to display the “Detail setting screen 1” on page 5-22.	—

5.3.16 Display setting screen 2

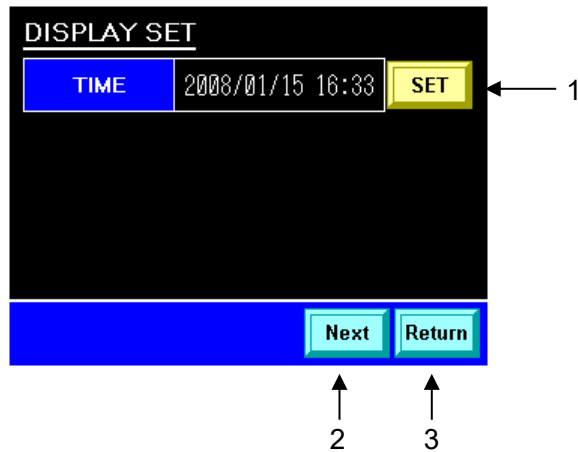

Figure 5-33 "Display Setting Screen 2"

Table 5-19 "Display Setting Screen 2"

No.	Item	Descriptions
1	TIME	Used to display the "Time setting screen" on page 5-25.
2	[Next] key	Used to display the "Display setting screen 1" on page 5-24.
3	[Return] key	Used to display the "Detail setting screen 1" on page 5-22.

5.3.17 Time setting screen

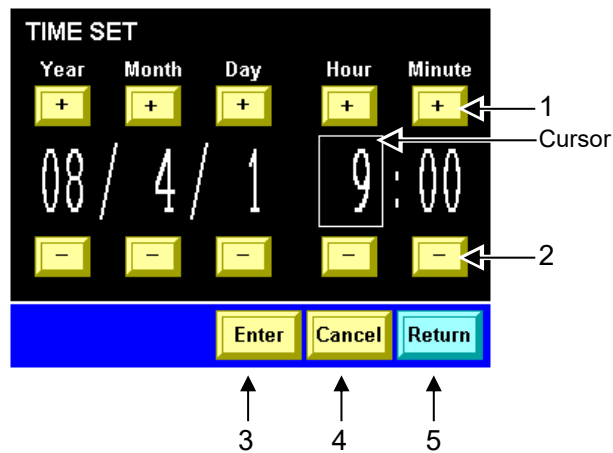

Figure 5-34 "Time Setting Screen"

Table 5-20 "Time Setting Screen"

No.	Item	Descriptions
1	[+] key	Used to increment a number.
2	[-] key	Used to decrement a number.
3	[Enter] key	Used to display the "MESSAGE screen" to set time.
4	[Cancel] key	Used to cancel time setting.
5	[Return] key	Used to display the "Display setting screen 2" on page 5-25.

■ Procedure for setting time

1. Touch the [+] or [-] key.

The cursor appears flashing, and a relevant number is incremented or decremented.

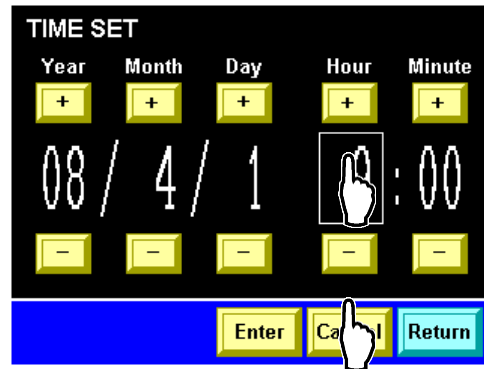

Figure 5-35 "Time Setting Screen"

2. Touch the [Enter] key.

The "MESSAGE screen" is displayed.

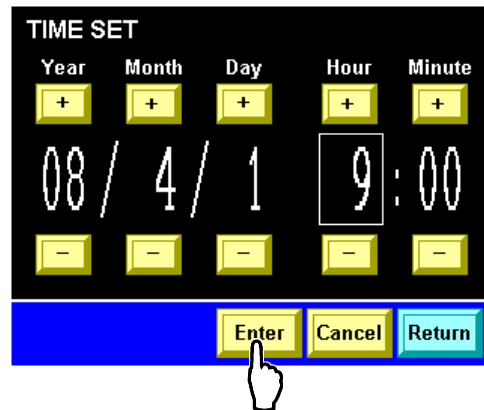

Figure 5-36 "Time Setting Screen"

3. Touch the [YES] key.

Time setting takes effect.



Figure 5-37 "MESSAGE Screen"

[Tips]

Time setting is not performed when the [NO] key is touched, which causes the "Time Setting screen" to be displayed.

5.3.18 Communication setting screen

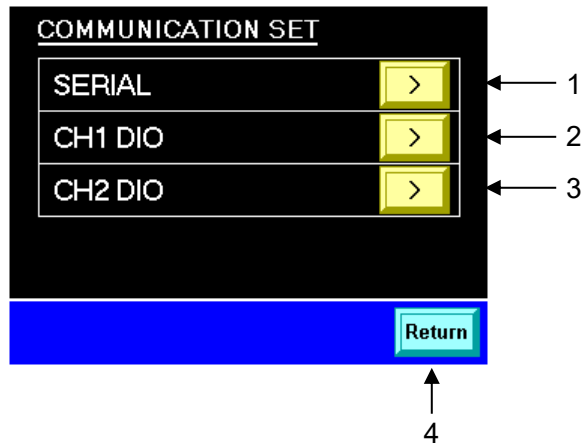

Figure 5-38 “Communication Setting Screen”

Table 5-21 “Communication Setting Screen”

No.	Item	Descriptions
1	SERIAL	Used to display the “Serial communication setting screen 1” on page 5-28.
2	CH1 DIO	Used to display the “CH1(2)DIO communication setting screen 1” on page 5-32.
3	CH2 DIO	Used to display the “CH1(2)DIO communication setting screen 1” on page 5-32.
4	[Return] key	Used to display the “Detail setting screen 1” on page 5-22.

[Tips]

For detail specification, refer to the separate product manual “Communication Specification”.

5.3.19 Serial communication setting screen 1

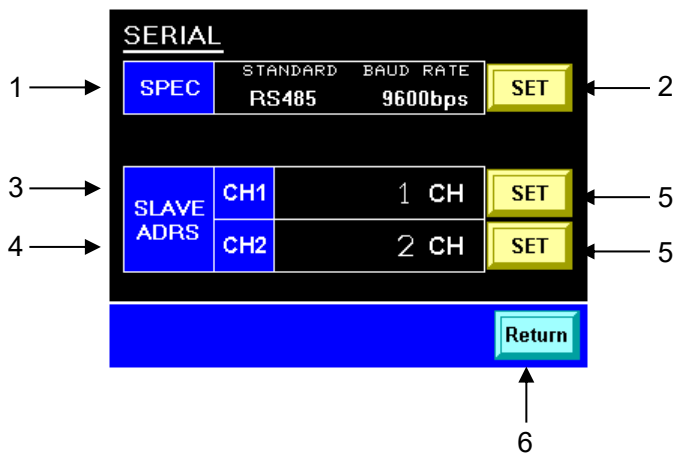

Figure 5-39 “Serial Communication Setting Screen 1”

Table 5-22 “Serial Communication Setting Screen 1”

No.	Item	Descriptions	Factory default
1	SPEC	Communication specifications and baud rate	—
2	[SET] key	Used to display the “Serial communication setting screen 2” on page 5-29.	—
3	SLAVE ADRS CH1	CH1 slave address	1CH
4	SLAVE ADRS CH2	CH2 slave address	2CH
5	[SET] key	Used to display the “Ten-key screen” to select a slave address for CH1(2).	—
6	[Return] key	Used to display the “Communication setting screen” on page 5-27.	—

[Tips]

CH1 and CH2 must be assigned with unique slave addresses respectively. The setting range is displayed on the “Ten-key screen” with the touch of the [SET] key.

5.3.20 Serial communication setting screen 2

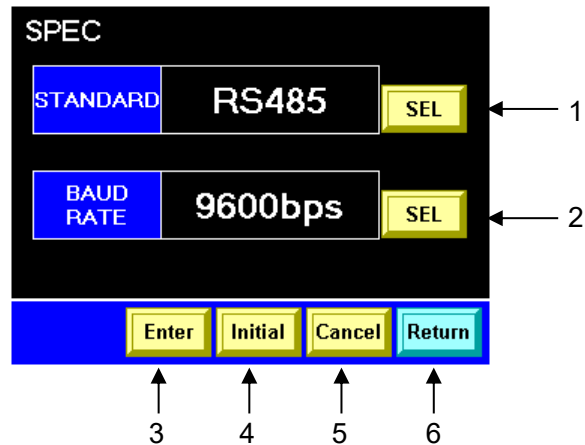

Figure 5-40 "Serial Communication Setting Screen 2"

Table 5-23 "Serial Communication Setting Screen 2"

No.	Item	Setting range	Descriptions	Factory default
1	[SEL] key	RS485, RS232C	Used to set communication specifications.	RS485
2	[SEL] key	9600bps, 19200bps	Used to set a baud rate.	9600bps
3	[Enter] key	—	Used to display the "MESSAGE screen" to accept the setting.	—
4	[Initial] key	—	Used to display the "MESSAGE screen" to initialize communication specifications and baud rate.	—
5	[Cancel] key	—	Used to cancel the setting.	—
6	[Return] key	—	Used to display the "Serial communication setting screen 1" on page 5-28.	—

■ Procedure for specifying communication specifications and baud rate

1. Touch the [SEL] key.

The box appears flashing. A set value changes with each touch of the key.

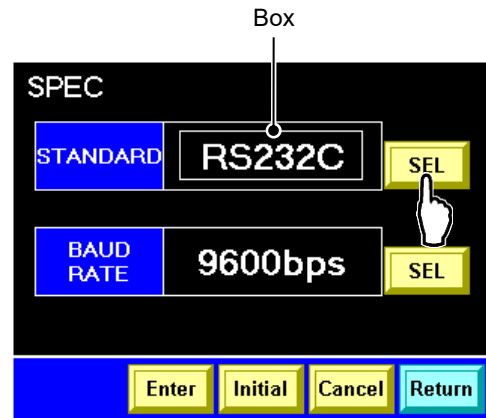

Figure 5-41 "Serial Communication Setting Screen 2"

[Tips]

The setting has not taken effect while the box is flashing.

2. Touch the [Enter] key.

The "MESSAGE screen" is displayed.

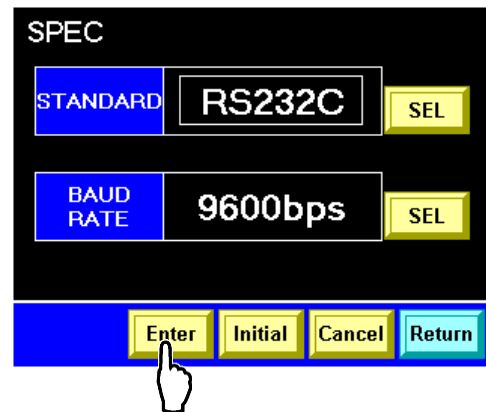

Figure 5-42 "Serial Communication Setting Screen 2"

3. Touch the [YES] key.

The setting takes effect.



Figure 5-43 "MESSAGE Screen"

[Tips]

The setting is not performed when the [NO] key is touched, which causes the "Serial Communication Setting screen 2" where the box is flashing to be displayed.

■ Procedure for initializing communication specifications and baud rate

1. Touch the [Initial] key.

The “MESSAGE screen” is displayed.

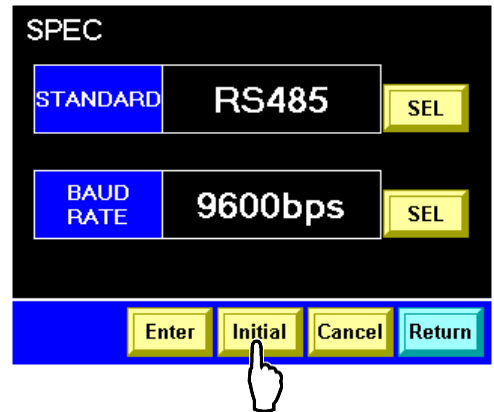

Figure 5-44 “Serial Communication Setting Screen 2”

2. Touch the [YES] key.

Initialization takes place.



Figure 5-45 “MESSAGE Screen”

[Tips]

Initialization is not performed when the [NO] key is touched, which causes the “Serial Communication Setting screen 2” to be displayed.

5.3.21 CH1(2)DIO communication setting screen 1

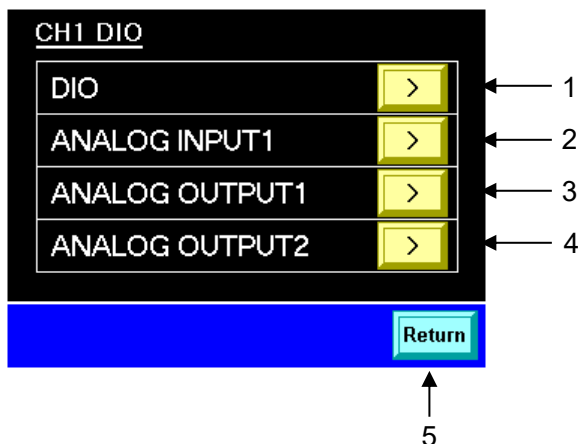

Figure 5-46 “CH1(2)DIO Communication Setting Screen 1”

Table 5-24 “CH1(2)DIO Communication Setting Screen 1”

No.	Item	Descriptions
1	DIO	Used to display the “CH1(2)DIO communication setting screen 2 on page 5-33.
2	ANALOG INPUT1	Used to display the “CH1(2) analog input setting screen on page 5-36.
3	ANALOG OUTPUT1	Used to display the “CH1(2) analog output setting screen 1, 2 on page 5-40.
4	ANALOG OUTPUT2	Used to display the “CH1(2) analog output setting screen 1, 2 on page 5-40.
5	[Return] key	Used to display the “Communication setting screen” on page 5-27.

[Tips]

For detail specification, refer to the separate product manual “Communication Specification”.

5.3.22 CH1(2)DIO communication setting screen 2

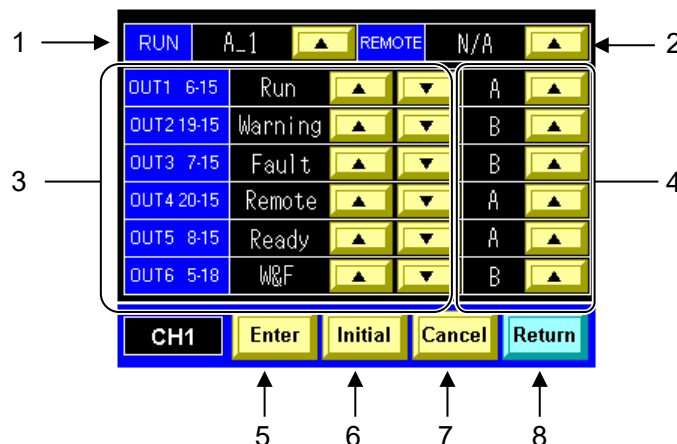

Figure 5-47 “CH1(2)DIO Communication Setting Screen 2”

Table 5-25 “CH1(2)DIO Communication Setting Screen 2”

No.	Item	Setting range	Descriptions	Factory default		
1	RUN	A_1, M_1, M_2, N/A	Allows the setting of the start (input) signal aspect.	A_1		
2	REMOTE	A_1, M_1, M_2, N/A	Allows the setting of the remote (input) signal aspect.	N/A		
3	OUT1 to OUT6 [Numbers following OUT1 to OUT6 refer to P1/P2 contact signal connector pin numbers.]	Alarm1 to Alarm 32	A relevant alarm is raised.	The output signal status switches once the product enters a set state. A setting-switching status relationship conforms to the setting range.	OUT1	Run Contact A
		Run	The product goes into action.		OUT2	Warning Contact B
		W&F	An alarm is raised.		OUT3	Fault Contact B
		Fault	Fault alarm is raised.		OUT4	Remote Contact A
		Warning	Warning alarm is raised.		OUT5	Ready Contact A
		Flow OK	Circulating fluid reaches a flow rate required for operation.		OUT6	W&F Contact B
		Ready	RDY lamp on the Main screen comes on.			
		Remote	DIO REMOTE mode is established for communication.			
		Purge	Circulating fluid is recovered.			
	N/A	Output signal: OFF (open) for normal operation				
4	OUT1 to OUT6	Contact A, B	Output signal A: Contact A, B: Contact B	Same as above		
5	[Enter] key	—	Used to display the “MESSAGE screen” to accept the setting.	—		
6	[Initial] key	—	Used to display the “MESSAGE screen” to initialize the settings of RUN, REMOTE, and OUT1 to OUT6.	—		
7	[Cancel] key	—	Used to cancel the setting.	—		
8	[Return] key	—	Used to display the “CH1(2)DIO communication setting screen 1” on page 5-32.	—		

■ **Procedure for setting RUN, REMOTE, and OUT1 to OUT6**

1. Touch the arrow [▲][▼] keys ([▲] key only for RUN and REMOTE).

The box appears flashing. A set value changes with each touch of the key.

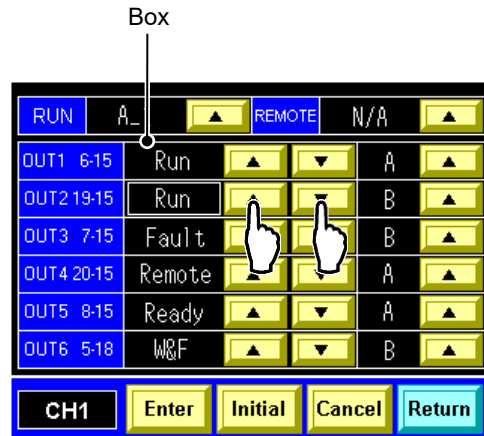

Figure 5-48 “CH1(2)DIO Communication Setting Screen 2”

[Tips]

The setting has not taken effect while the box is flashing.

2. Touch the [Enter] key.

The “MESSAGE screen” is displayed.

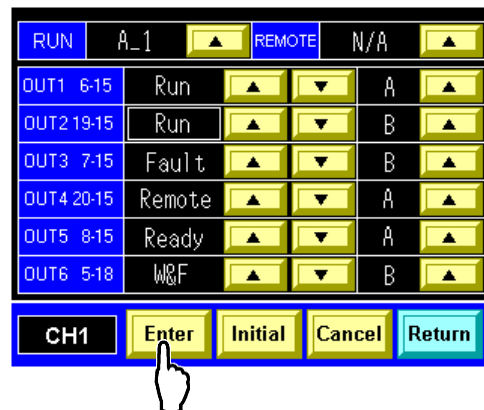

Figure 5-49 “CH1(2)DIO Communication Setting Screen 2”

3. Touch the [YES] key.

The setting takes effect.



Figure 5-50 “MESSAGE Screen”

[Tips]

The setting is not performed when the [NO] key is touched, which causes the “CH1(2)DIO Communication Setting screen 2” where the box is flashing to be displayed.

■ **Procedure for initializing RUN, REMOTE, and OUT1 to OUT6 settings**

1. Touch the [Initial] key.

The “MESSAGE screen” is displayed.

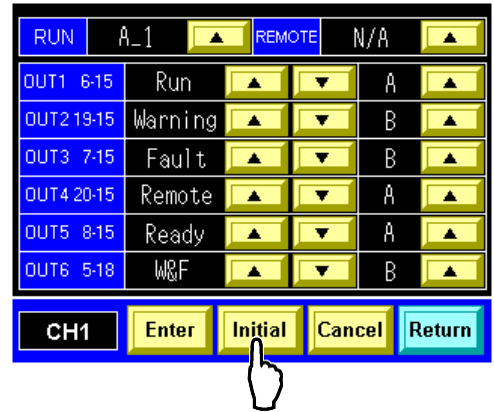

Figure 5-51 “CH1(2)DIO Communication Setting Screen 2”

2. Touch the [YES] key.

Initialization takes place.

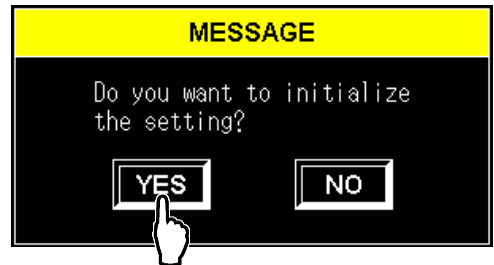

Figure 5-52 “MESSAGE Screen”

[Tips]

Initialization is not performed when the [NO] key is touched, which causes the “CH1(2)DIO Communication Setting screen 2” to be displayed.

5.3.23 CH1(2) analog input setting screen

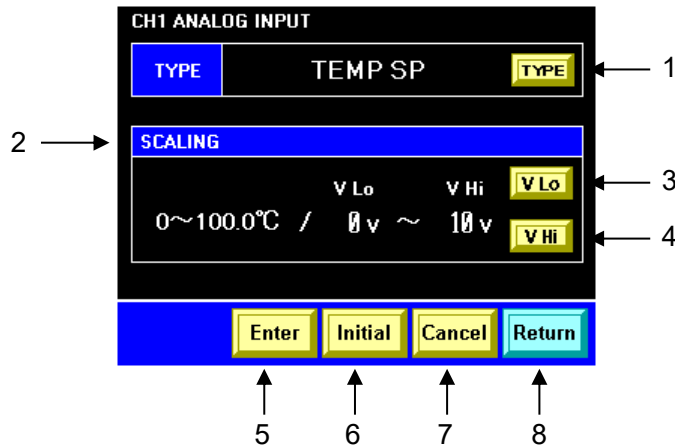

Figure 5-53 “CH1(2) Analog Input Setting Screen 1”

Table 5-26 “CH1(2) Analog Input Setting Screen 1”

No.	Item	Setting range	Descriptions	Factory default
1	[TYPE] key	DI SP, N/A, TEMP SP, FLOW SP	Used to specify the type of analog input signal. DI SP is displayed only if the DI control kit (optional) is provided.	TEMP SP
2	SCALING	—	Used to specify the scaling of analog input signal.	—
3	[V Lo] key	—	Used to display the “Ten-key screen”.	0 V
4	[V Hi] key	—	Used to display the “Ten-key screen”.	10 V
5	[Enter] key	—	Used to display the “MESSAGE screen” to accept the setting.	—
6	[Initial] key	—	Used to display the “MESSAGE screen” to initialize the settings of TYPE and SCALING.	—
7	[Cancel] key	—	Used to cancel the setting.	—
8	[Return] key	—	Used to display the “CH1(2)DIO communication setting screen 1” on page 5-32.	—

[Tips]

The setting range of items is displayed on the “Ten-key screen” with the touch of the [V Lo] or [V Hi] key.

A scaling must be specified to cause V Hi to be larger than V Lo (V Lo < V Hi).

■ Procedure for setting analog input signal TYPE

1. Touch the [TYPE] key.

The box appears flashing. A set value changes with each touch of the key.

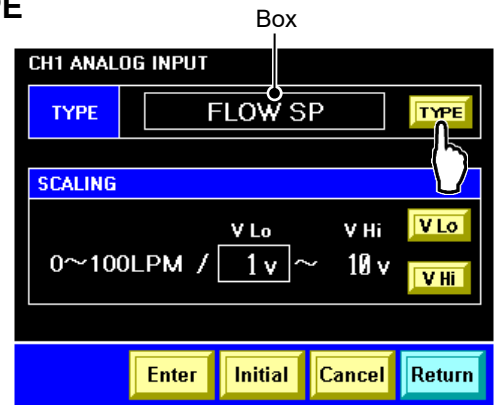

Figure 5-54 “CH1(2) Analog Input Setting Screen 1”

[Tips]

The setting has not taken effect while the box is flashing.

2. Touch the [Enter] key.

The “MESSAGE screen” is displayed.

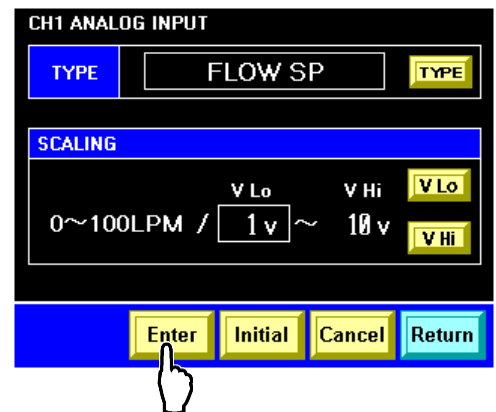

Figure 5-55 “CH1(2) Analog Input Setting Screen 1”

3. Touch the [YES] key.

The setting takes effect.



Figure 5-56 “MESSAGE Screen”

[Tips]

The setting is not performed when the [NO] key is touched, which causes the “CH1(2) Analog Input Setting screen 2” where the box is flashing to be displayed.

■ Procedure for setting analog input signal SCALING

1. Touch the [V Lo] key or [V Lo] key.

The “Ten-key screen” is displayed.

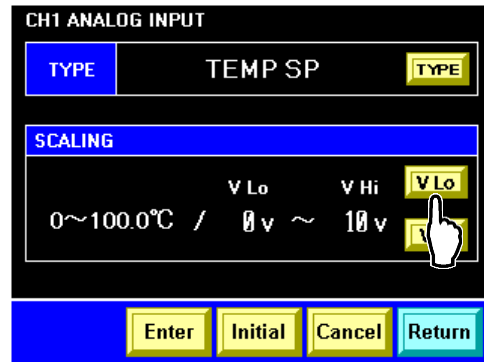

Figure 5-57 “CH1(2) Analog Input Setting Screen 1”

2. Use the ten-key to input a set value, and touch the [ENT] key.

The “CH1(2) Analog Input Setting screen 1” is displayed, and the box appears flashing.

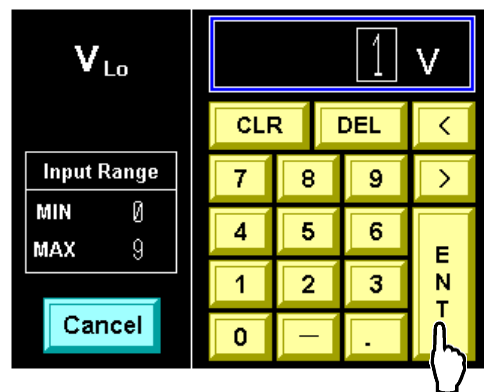

Figure 5-58 “Ten-key Screen”

[Tips]

The setting has not taken effect while the box is flashing.

A scaling must be specified to cause V Hi to be larger than V Lo (V Lo<V Hi).

3. Touch the [Enter] key.

The “MESSAGE screen” is displayed.

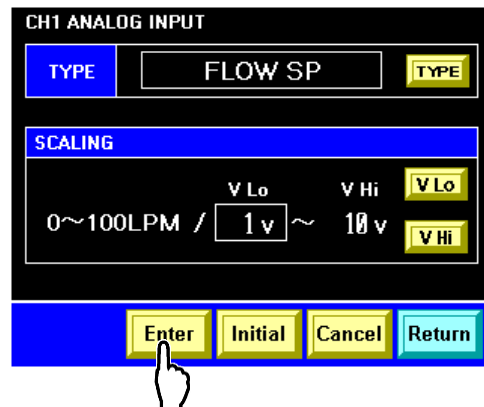

Figure 5-59 “CH1 Analog Input Setting Screen 1”

[Tips]

The setting has not taken effect while the box is flashing.

4. Touch the [YES] key.
The setting takes effect.



Figure 5-60 "MESSAGE Screen"

[Tips]

The setting is not performed when the [NO] key is touched, which causes the "CH1(2) Analog Input Setting screen 1" where the box is flashing to be displayed.

■ Procedure for initializing RUN, REMOTE, and OUT1 to OUT6 settings

1. Touch the [Initial] key.
The "MESSAGE screen" is displayed.

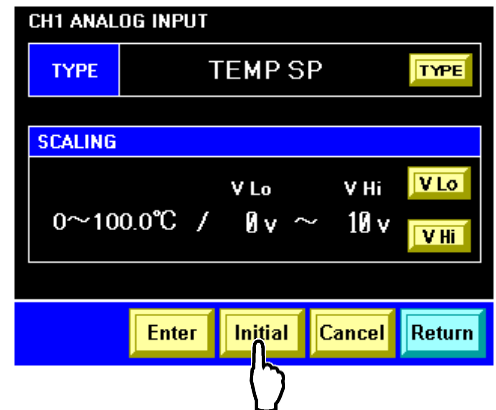

Figure 5-61 "CH1(2) Analog Input Setting Screen 1"

2. Touch the [YES] key.
Initialization takes place.



Figure 5-62 "MESSAGE Screen"

[Tips]

Initialization is not performed when the [NO] key is touched, which causes the "CH1(2) Analog Input Setting screen 1" to be displayed.

5.3.24 CH1(2) analog output setting screen 1, 2

The “CH* analog output setting screen 1” can set output1 and the “CH* analog output setting screen 2” can set output 2.

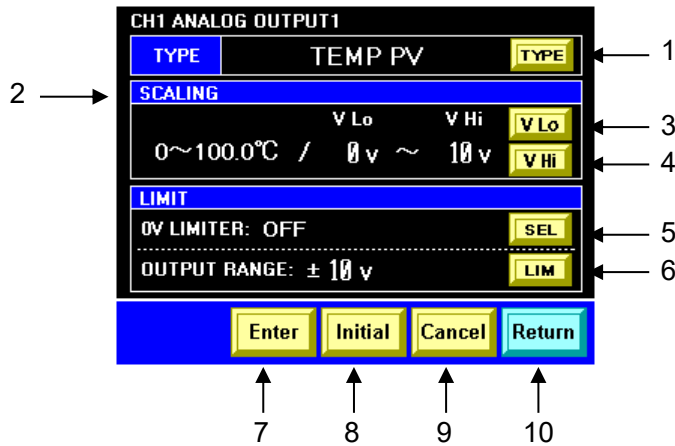

Figure 5-63 “CH1(2) Analog Output Setting Screen 1, 2”

Table 5-27 “CH1(2) Analog Output Setting Screen 1, 2”

No.	Item	Setting range	Descriptions	Factory default	
1	TYPE	DI PV, DI SP, N/A, TEMP PV, TEMP SP, FLOW PV, FLOW SP, PRESS	Used to specify the type of analog output signal. DI PV, DI SP is displayed only if the DI control kit (optional) is provided.	OUTPUT 1	TEMP PV
				OUTPUT 2	FLOW PV
2	SCALING	—	Used to specify the scaling of analog output signal.	—	
3	[V Lo] key	—	Used to display the “Ten-key screen”.	0 V (OUTPUT1,2)	
4	[V Hi] key	—	Used to display the “Ten-key screen”.	10 V (OUTPUT1,2)	
5	[SEL] key	ON,OFF	Output voltage remains larger than 0V when this is valid (set to ON).	OFF (OUTPUT1,2)	
6	[LIM] key		Used to set a limit for the output voltage range (analog voltage output limiter). The “Ten-key screen” is displayed.	10 V (OUTPUT1,2)	
7	[Enter] key	—	Used to display the “MESSAGE screen” to accept the setting.	—	
8	[Initial] key	—	Used to display the “MESSAGE screen” to initialize the settings of TYPE, SCALING, and LIMIT.	—	
9	[Cancel] key	—	Used to cancel the setting.	—	
10	[Return] key	—	Used to display the “CH1(2)DIO communication setting screen 1” on page 5-32.	—	

[Tips]

The setting range of items is displayed on the “Ten-key screen” with the touch of the [V Lo] or [V Hi] key.

A scaling must be specified to cause V Hi to be larger than V Lo (V Lo<V Hi).

Procedure for setting analog output signal TYPE

1. Touch the [TYPE] key.

The box appears flashing. A set value changes with each touch of the key.

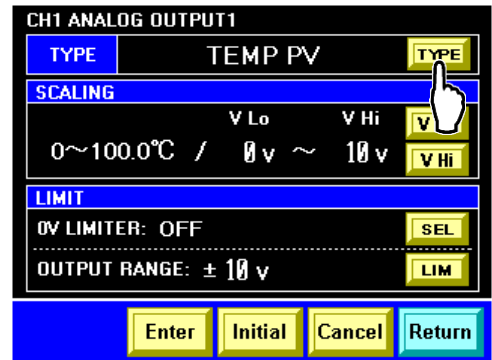

Figure 5-64 “CH1(2) Analog Output Setting Screen 1, 2”

[Tips]

The setting has not taken effect while the box is flashing.

2. Touch the [Enter] key.

The “MESSAGE screen” is displayed.

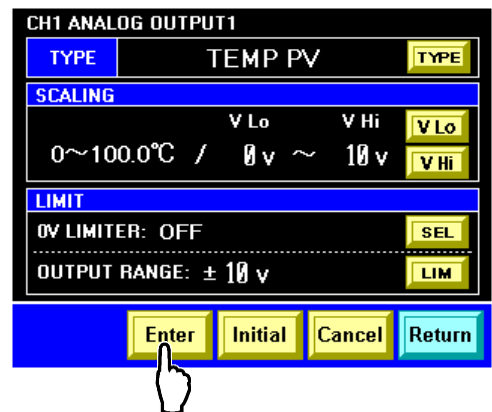

Figure 5-65 “CH1(2) Analog Output Setting Screen 1, 2”

3. Touch the [YES] key.

The setting takes effect.

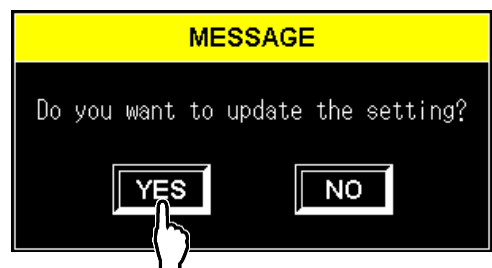

Figure 5-66 “MESSAGE Screen”

[Tips]

The setting is not performed when the [NO] key is touched, which causes the “CH1(2) Analog Output Setting screen 1, 2” where the box is flashing to be displayed.

■ Procedure for setting analog output signal SCALING

1. Touch the [V Lo] key or [V Lo] key.

The “Ten-key screen” is displayed.

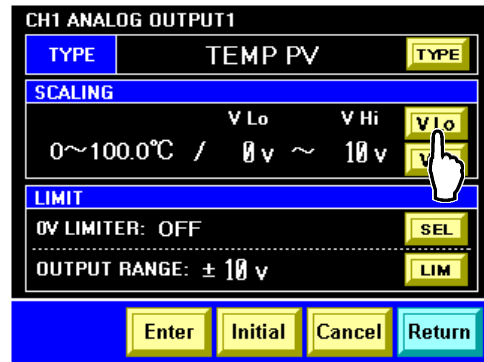

Figure 5-67 “CH1(2) Analog Output Setting Screen 1, 2”

2. Use the ten-key to input a set value, and touch the [ENT] key.

The “CH1(2) Analog Output Setting screen 1, 2” is displayed, and the box appears flashing.

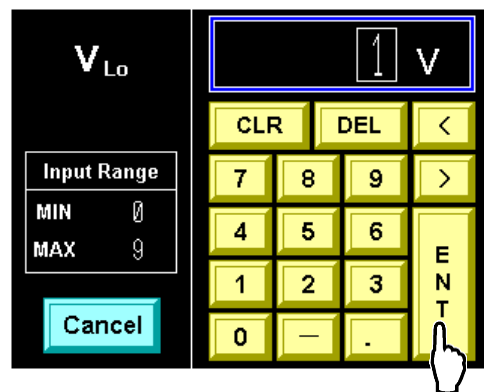

Figure 5-68 “Ten-key Screen”

[Tips]

The setting has not taken effect while the box is flashing.

A scaling must be specified to cause V Hi to be larger than V Lo (V Lo < V Hi).

3. Touch the [Enter] key.

The “MESSAGE screen” is displayed.

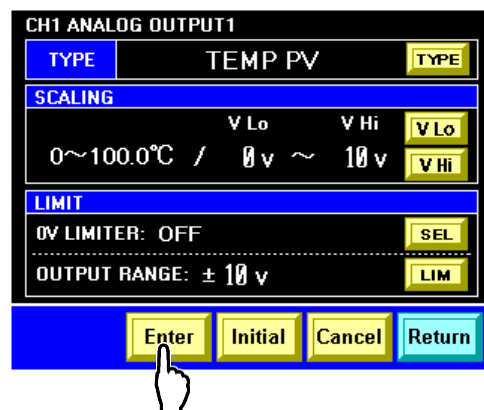

Figure 5-69 “CH1(2) Analog Output Setting Screen 1, 2”

[Tips]

The setting has not taken effect while the box is flashing.

4. Touch the [YES] key.

The setting takes effect.



Figure 5-70 "MESSAGE Screen"

[Tips]

The setting is not performed when the [NO] key is touched, which causes the "CH1(2) Analog Output Setting screen 1, 2" where the box is flashing to be displayed.

■ Procedure for initializing TYPE, SCALING, and LIMIT settings

1. Touch the [Initial] key.

The "MESSAGE screen" is displayed.

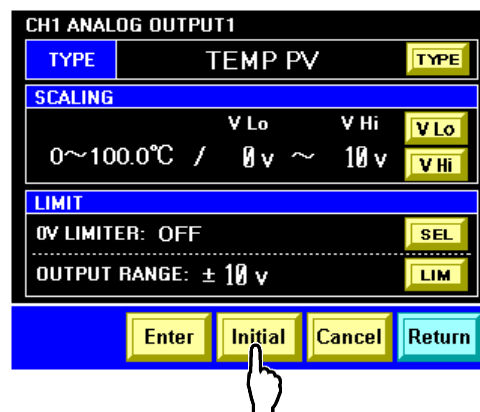

Figure 5-71 "CH1(2) Analog Output Setting Screen 1, 2"

2. Touch the [YES] key.

Initialization takes place.

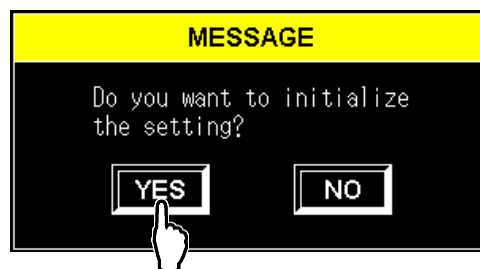

Figure 5-72 "MESSAGE Screen"

[Tips]

Initialization is not performed when the [NO] key is touched, which causes the "CH1(2) Analog Output Setting screen 1, 2" to be displayed.

5.3.25 Control setting screen

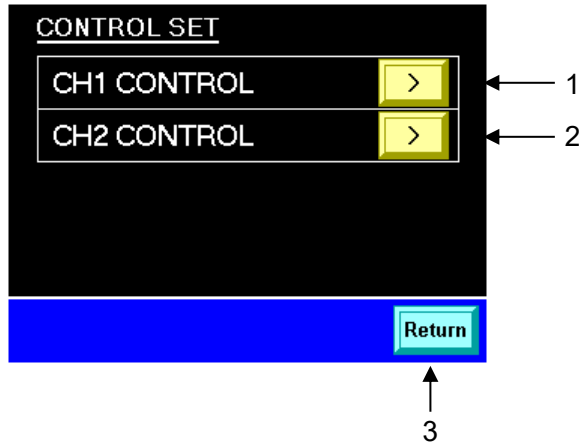

Figure 5-73 "Control Setting Screen"

Table 5-28 "Control Setting Screen"

No.	Item	Descriptions
1	CH1 CONTROL	Used to display the "CH1 control setting screen" on page 5-44.
2	CH2 CONTROL	Used to display the "CH2 control setting screen" on page 5-44.
3	[Return] key	Used to display the "Detail setting screen 1" on page 5-22.

5.3.26 CH1(2) control setting screen

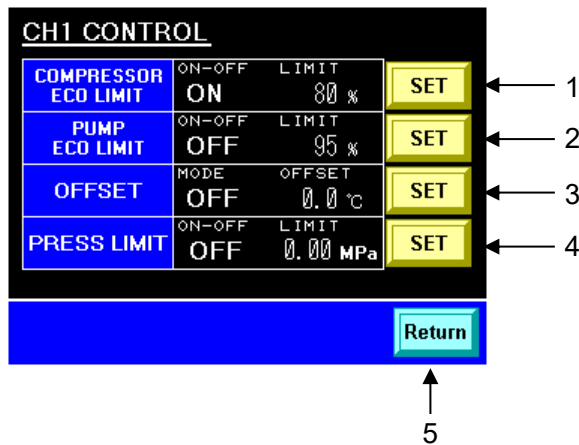

Figure 5-74 "CH1(2) Control Setting Screen"

Table 5-29 "CH1(2) Control Setting Screen"

No.	Item	Descriptions
1	COMPRESSOR ECO LIMIT	Used to display the "CH1(2) Compressor ECO Limit setting screen" on page 5-45.
2	PUMP ECO LIMIT	Used to display the "CH1(2)" on page 5-46.
3	OFFSET	Used to display the "CH1(2) offset setting screen" on page 5-47.
4	PRESS LIMITER	Used to display the "CH1(2) circulating fluid discharge pressure limit setting screen" on page 5-48.
5	[Return] key	Used to display the "Control setting screen" on page 5-44.

5.3.27 CH1(2) Compressor ECO Limit setting screen

The Compressor ECO Limit Setting screen enables the setting of a limit to compressor performance.

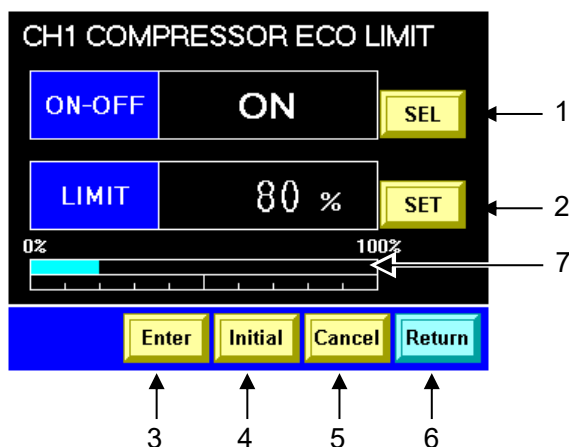

Figure 5-75 “Compressor ECO Limit Setting Screen”

Table 5-30 “Compressor ECO Limit Setting Screen”

No.	Item	Setting range	Descriptions	Factory default
1	[SEL] key	ON, OFF	“C.E” is displayed in CNT on the Main screen and the LIMIT value is displayed on the “Status screen 2” when this is valid (set to ON).	OFF
2	[SET] key	—	Used to display the “Ten-key screen”.	100%
3	[Enter] key	—	Used to display the “MESSAGE screen” to accept the setting.	—
4	[Initial] key	—	Used to display the “MESSAGE screen” to initialize the setting.	—
5	[Cancel] key	—	Used to cancel the setting.	—
6	[Return] key	—	Used to display the “CH1(2) control setting screen” on page 5-44.	—
7	Output indicator	—	This indicates the current output of the compressor.	—

[Tips]

The setting of a LIMIT value takes effect only when the [ENTER] key is touched with ON-OFF setting set to ON.

The indicator is designed to turn red when an output value exceeds the limit.

The setting range is displayed on the “Ten-key screen” with the touch of the [SET] key.

5.3.28 CH1(2) Pump ECO Limit setting screen

The Pump ECO Limit Setting screen enables the setting of a limit to pump performance. If the setting of the circulating fluid discharge pressure limit is valid, the discharge pressure limit of the circulating fluid overrides the Pump ECO Limit.

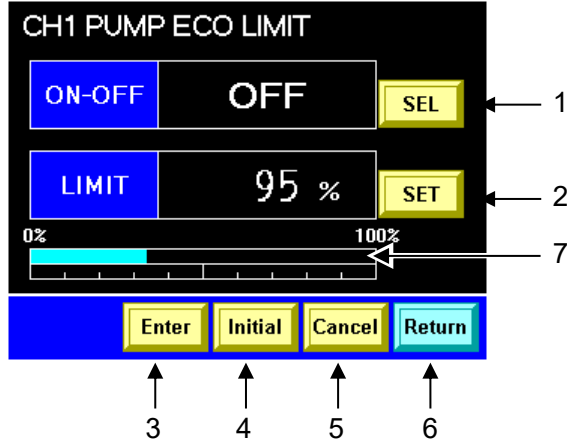

Figure 5-76 “Pump ECO Limit Setting Screen”

Table 5-31 “Pump ECO Limit Setting Screen”

No.	Item	Setting range	Descriptions	Factory default
1	[SEL] key	ON, OFF	“P.E” is displayed in CNT on the Main screen and the LIMIT value is displayed on the “Status screen 2” when this is valid (set to ON).	OFF
2	[SET] key	—	Used to display the “Ten-key screen”.	100%
3	[Enter] key	—	Used to display the “MESSAGE screen” to accept the setting.	—
4	[Initial] key	—	Used to display the “MESSAGE screen” to initialize the setting.	—
5	[Cancel] key	—	Used to cancel the setting.	—
6	[Return] key	—	Used to display the “CH1(2) control setting screen” on page 5-44.	—
7	Output indicator	—	This indicates the current output of the pump.	—

[Tips]

The setting of a LIMIT value takes effect only when the [ENTER] key is touched with ON-OFF setting set to ON.

The indicator is designed to turn red when an output value exceeds the limit.

The setting range is displayed on the “Ten-key screen” with the touch of the [SET] key.

5.3.29 CH1(2) offset setting screen

The Offset Setting screen enables the selection of offset mode.

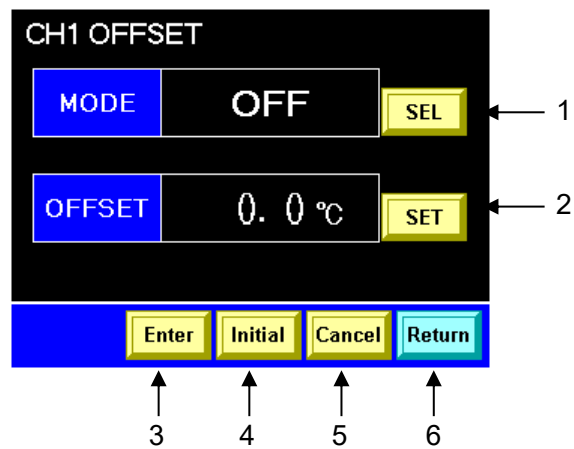

Figure 5-77 “Offset Setting Screen”

Table 5-32 “Offset Setting Screen”

No.	Item	Setting range	Descriptions	Factory default
1	[SEL] key	OFF, MODE1, MODE2, MODE3	“MD*” is displayed in CNT on the Main screen when this is valid. See “8.4 Offset Function” in Chapter 8 Appendixon page 8-14.	OFF
2	[SET] key	—	Used to display the “Ten-key screen”.	0.0°C
3	[Enter] key	—	Used to display the “MESSAGE screen” to accept the setting.	—
4	[Initial] key	—	Used to display the “MESSAGE screen” to initialize the setting.	—
5	[Cancel] key	—	Used to cancel the setting.	—
6	[Return] key	—	Used to display the “CH1(2)” on page 5-44.	—

[Tips]

The setting of an OFFSET value takes effect only when the [ENTER] key is touched with ON-OFF setting set to ON.

The setting range is displayed on the “Ten-key screen” with the touch of the [SET] key.

5.3.30 CH1(2) circulating fluid discharge pressure limit setting screen

The Circulating Fluid Discharge Pressure Limit Setting screen enables the setting of a limit to discharge pressure of the circulating fluid. The setting overrides the Pump ECO Limit.

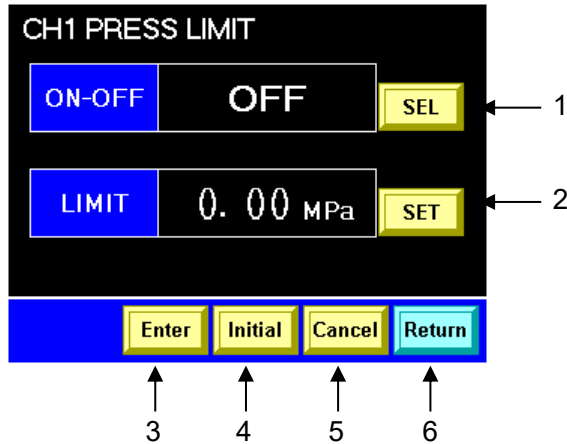

Figure 5-78 “Circulating Fluid Discharge Pressure Limit Setting Screen”

Table 5-33 “Circulating Fluid Discharge Pressure Limit Setting Screen”

No.	Item	Setting range	Descriptions	Factory default
1	[SEL] key	ON, OFF	The LIMIT value is displayed on the “Status screen 1” when this is valid (set to ON). Discharge pressure of the circulating fluid must remain below the limit.	OFF
2	[SET] key	—	Used to display the “Ten-key screen”.	2.0MPa
3	[Enter] key	—	Used to display the “MESSAGE screen” to accept the setting.	—
4	[Initial] key	—	Used to display the “MESSAGE screen” to initialize the setting.	—
5	[Cancel] key	—	Used to cancel the setting.	—
6	[Return] key	—	Used to display the “CH1(2)” on page 5-44.	—

[Tips]

The setting of a LIMIT value takes effect only when the [ENTER] key is touched with ON-OFF setting set to ON.

The setting range is displayed on the “Ten-key screen” with the touch of the [SET] key.

5.3.31 Maintenance screen

CAUTION

The “Maintenance screen” is to be used in the event of an error including abnormal temperature control. Do not use this screen for product operation.

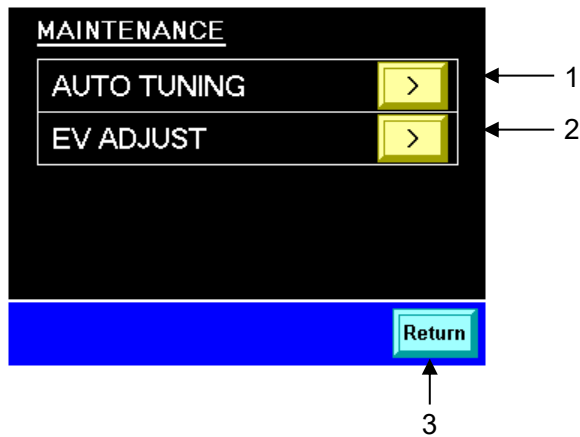

Figure 5-79 “Maintenance Screen”

Table 5-34 “Maintenance Screen”

No.	Item	Descriptions
1	AUTO TUNING	Used to display the “Auto tuning screen” on page 5-50.
2	EV ADJUST	Used to display the “EV opening adjustment screen” on page 5-51.
3	[Return] key	Used to display the “Detail setting screen 1” on page 5-22.

5.3.32 Auto tuning screen

CAUTION

The “Auto Tuning screen” is to be used in the event of an error including abnormal temperature control. Do not use this screen for product operation.

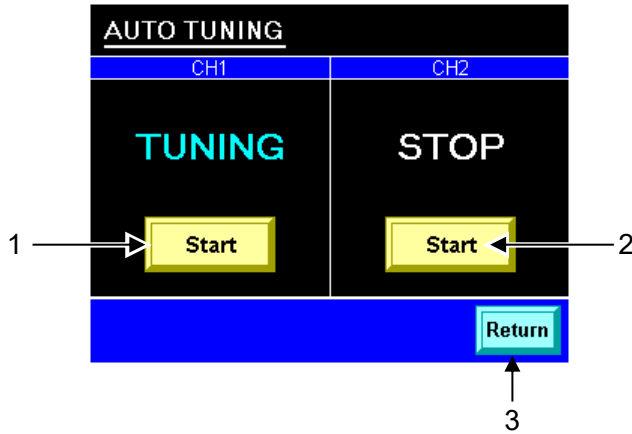



Figure 5-80 “Auto Tuning Screen”

Table 5-35 “Auto Tuning Screen”

No.	Item	Descriptions
1	[Start] key	Used to display the “MESSAGE screen” to perform auto tuning of CH1.  TUNNING: During auto tuning STOP: Stopped
2	[Start] key	Used to display the “MESSAGE screen” to perform auto tuning of CH2.  TUNNING: During auto tuning STOP: Stopped
3	[Return] key	Used to display the “Maintenance screen” on page 5-49.

[Tips]

It is not abnormal that circulating fluid temperature go up temporarily by auto tuning.

5.3.33 EV opening adjustment screen

CAUTION

The “Auto Opening Adjustment screen” is to be used in the event of an error including abnormal temperature control. Do not use this screen for product operation.

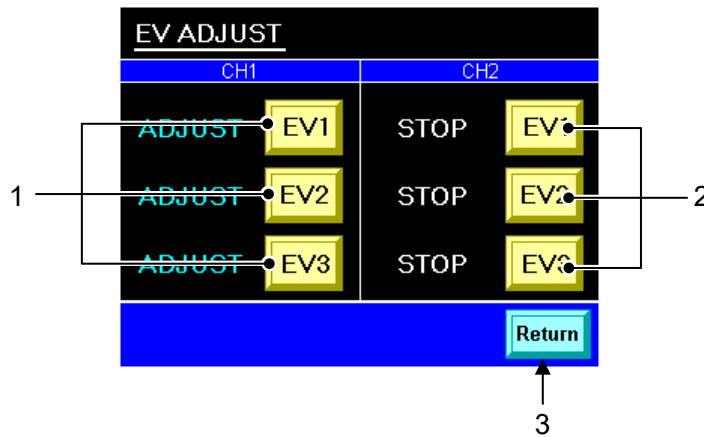



Figure 5-81 “Auto Opening Adjustment Screen”

Table 5-36 “Auto Opening Adjustment Screen”

No.	Item	Descriptions
1	[EV1] to [EV3] key	Used to display the “MESSAGE screen” to adjust the origin of CH1 electron expansion valves.  ADJUST: During origin adjustment of electron expansion valve STOP: Stopped
2	[EV1] to [EV3] key	Used to display the “MESSAGE screen” to adjust the origin of CH2 electron expansion valves.  ADJUST: During origin adjustment of electron expansion valve STOP: Stopped
3	[Return] key	Used to display the “Maintenance screen” on page 5-49.

[Tips]

It is not abnormal that circulating fluid temperature go up temporarily by EV opening adjustment.

5.3.34 Purge mode screen

CAUTION

The “Purge Mode screen” is displayed only if the Automatic circulating fluid collector (optional) is provided.

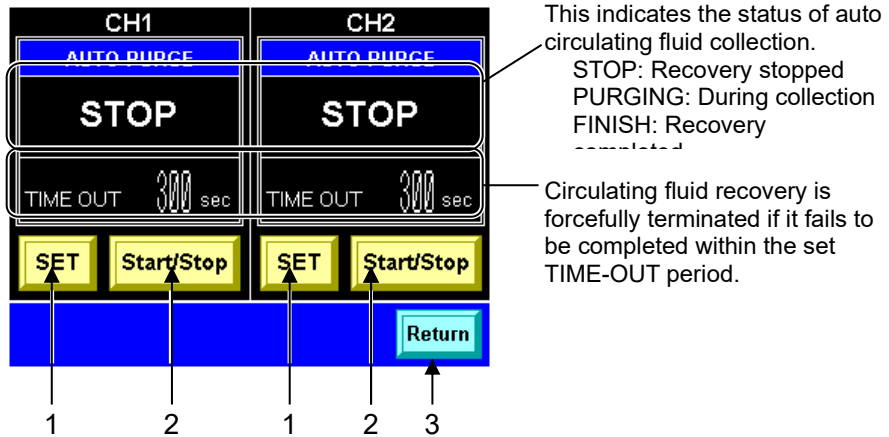

Figure 5-82 “Purge Mode Screen”

Table 5-37 “Purge Mode screen”

No.	Item	Descriptions	
1	STOP	Collection stopped	Circulating fluid collection is automatically finished when completed successfully. The ERROR window is displayed in the event of an error. See page 5-53 for details.
	PURGING	During collection	
	FINISH	Collection completed successfully	
1	[SET] key	Used to display the “Ten-key screen” to set the CH1(2) TIME-OUT.	
2	[Start/Stop] key	Used to start/stop circulating fluid collection of CH1(2).	The following “MESSAGE screen” is displayed when the product is capable of fluid recovery. <div style="border: 1px solid black; background-color: #00ff00; padding: 5px; margin: 5px;"> <p style="text-align: center; color: black; font-weight: bold;">MESSAGE</p> <p style="text-align: center;">Do you want to purge the fluid?</p> <p style="text-align: center;"> <input type="button" value="YES"/> <input type="button" value="NO"/> </p> </div>
			The following “MESSAGE screen” is displayed when the product is not capable of fluid recovery. <div style="border: 1px solid black; background-color: #ffff00; padding: 5px; margin: 5px;"> <p style="text-align: center; color: black; font-weight: bold;">MESSAGE</p> <p>The fluid cannot be purged for the following reason.</p> <p>The circulating fluid temperature is outside of the specified range.</p> <p>An alarm is generating.</p> <p>This system is in the Remote mode.</p> <p>This system is operating.</p> <p>AUTO PURGE is TIME OUT.</p> <p style="text-align: center;"> <input type="button" value="OK"/> </p> </div>
3	[Return] key	Used to display the “Detail setting screen 2” on page 5-23.	

[Tips]

The TIME-OUT period is factory-configured to 300 seconds.

The setting range is displayed on the “Ten-key screen” with the touch of the [SET] key.

■ In the event of an error

The ERROR window shown below is displayed when an error occurs that results in the termination of ongoing circulating fluid recovery. Fluid collection is stopped accordingly.

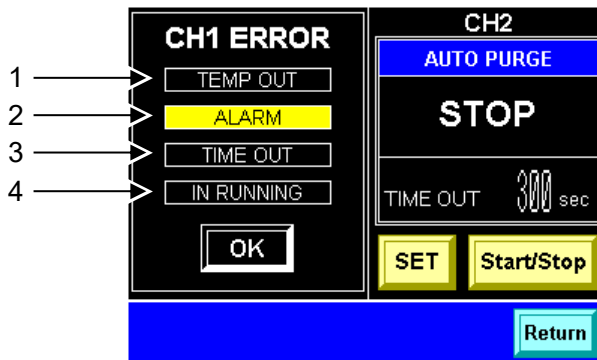

Figure 5-83 “Purge Mode Screen”: ERROR Window (E.g.: ALARM)

The lamp stated below comes on corresponding to error type.

Table 5-38 “Purge Mode Screen”: ERROR Window

No.	Item	Descriptions
1	TEMP OUT	The circulating fluid temperature is out of the range. (Circulating fluid temperature: Beyond the 10-to-30-°C range)
2	ALARM	COM-01: Water Leak Detect FLT or CH*-07: Reservoir High Level WRN alarm is raised. The Alarm List screen is displayed when other alarm is raised, and circulating fluid recovery carries on.
3	TIME OUT	Circulating fluid collection is not completed within the TIME-OUT period.
4	IN RUNNING	The product goes into action.

Chapter 6 Error Message and Troubleshooting

6.1 Error Message

The following events happen when the product has an error.

- The “ALARM” lamp comes on.
- Alarm buzzer comes on.
- The “Alarm Display screen” is displayed on the operation touch panel.
- Error signal is issued through external communication.
(See section 8.1.3 Communication specification” in Chapter 8 Appendix for details.)
- This product is brought to a stop forcefully according to error types.

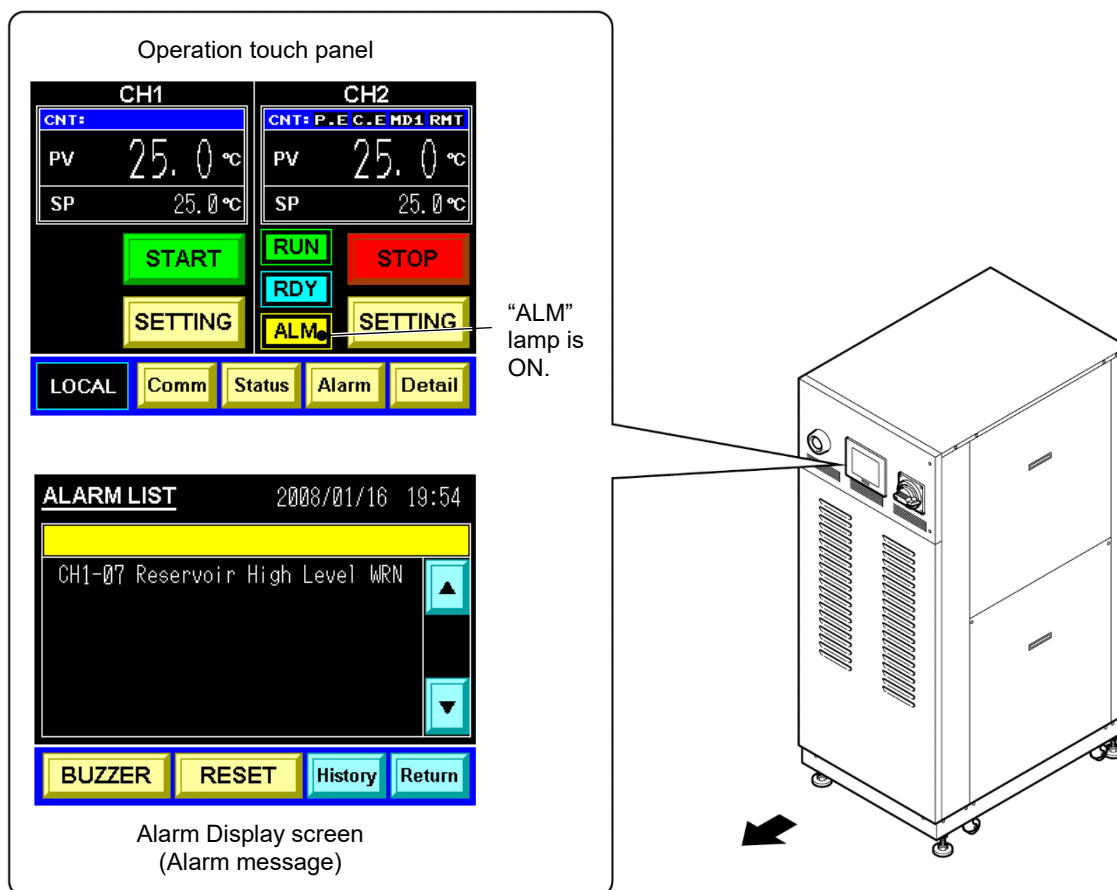

Figure 6-1 Error Occurrence

6.2 Troubleshooting

The procedure for error recovery varies with alarm types.

- Alarm Code.01 to 21, 22, 24, 25, 28:
Eliminate the error cause, then press the [RESET] key on the operation display panel or power cycle the main breaker to recover from the error.
- Alarm Code. 30, 99:
Eliminate the error cause, and power cycle the main breaker to recover from the error.
- Alarm Code.23:
Automatic error recovery happens when the cause of the error is eliminated.
- Alarm Code.18, 24:
This is an alarm for accessories (optional).
No alarm of this type is issued if the product is fitted with no accessories.

Table 6-1 Troubleshooting (1/3)

Code		Error message	Product condition	Cause	Remedies
COM-01		Water Leak Detect FLT	Stop	The fluid is pooled at the base of the product.	Check for fluid leak.
CH1-03	CH2-03	RFGT High Press FLT	Stop	The pressure of the refrigerant circuit exceeded the specified value.	Check that facility water is being supplied to the product in accordance with specifications.
CH1-05	CH2-05	Reservoir Low Level FLT	Stop	An insufficient amount of the circulating fluid is observed in the tank.	Refill the circulating fluid.
CH1-06	CH2-06	Reservoir Low Level WRN	Continued	An insufficient amount of the circulating fluid is observed in the tank.	Refill the circulating fluid.
CH1-07	CH2-07	Reservoir High Level WRN	Continued	An excessive amount of the circulating fluid is observed in the tank.	Drain the circulating fluid.
CH1-08	CH2-08	Temp. Fuse Cutout FLT	Stop	The circulating fluid tank was raised in temperature.	Check the load specification. Replacement of the thermal fuse is required. Call the supplier for service.
CH1-09	CH2-09	Reservoir High Temp. FLT	Stop	The temperature of the circulating fluid exceeded the specified value. <Specified value> 95°C	Check the load specification.
CH1-11	CH2-11	Reservoir High Temp. WRN	Continued	The temperature of the circulating fluid exceeded your specified value. <Setting range> -30 to 93°C	Reset the setting temperature.
CH1-12	CH2-12	Discharge Low Flow FLT	Stop	The flow rate of the circulating fluid falls short of 6L/min.	Check that the external valve is opened. Prepare a thicker external pipe or install bypass piping.
CH1-13	CH2-13	Discharge Low Flow WRN	Continued	The flow rate in the product falls short of your specified value. <Setting range> 10 to 40L/min	Reset the setting flow rate.
CH1-14	CH2-14	Heater Breaker Trip FLT	Stop	The breaker for the heater power line was tripped.	Check that the power supply to the product is compliant with the specification.

Table 6-1 Troubleshooting (2/3)

Code		Error message	Product condition	Cause	Remedies	
CH1-15	CH2-15	Pump Breaker Trip FLT	Stop	The breaker for the circulating pump power line was tripped.	Check that the power supply to the product is compliant with the specification.	
CH1-16	CH2-16	CPRSR Breaker Trip FLT	Stop	The breaker for the compressor power line was tripped.	Check that the power supply to the product is compliant with the specification.	
CH1-17	CH2-17	Interlock Fuse Cutout FLT	Stop	An overcurrent was passed through the control circuit.	Contact the product supplier for request of inspection and repair.	
CH1-18	CH2-18	DC Fuse Cutout WRN	Continued	An overcurrent was passed through the solenoid valve (optional).	Contact the product supplier for request of inspection and repair.	
CH1-19	CH2-19	FAN Motor Stop WRN	Continued	The ventilating fan has stopped.	Check that the air vent on the back of the product is not blocked.	
CH1-20	CH2-20	Int. Pump Time Out WRN	Continued	The internal pump was under conditions of continuous operation over a specified time.	Check for fluid leak from circulating fluid piping in your system.	
CH1-21	CH2-21	Controller Error FLT	Stop	-COMM	An interruption of communication occurred between the product controllers.	Contact the product supplier for request of inspection and repair.
				-PT1	An error was detected in the temperature sensor of the circulating fluid circuit.	Check the temperature sensor for broken wires.
				-PT2	An error was detected in the temperature sensor of the refrigerating circuit.	Check the temperature sensor for broken wires.
				-PT3		
				-TH1		
				-TH2		
				-TH3	An error was detected during auto tuning of the electron expansion valve.	Contact the product supplier for request of inspection and repair.
				-AT1		
-AT2						
		-LMT	An error was detected in internal processing of the product.	Contact the product supplier for request of inspection and repair.		
		-EV2	An error was detected in the electron expansion valve.	Contact the product supplier for request of inspection and repair.		
COM-22		Memory Data Error FLT	Stop	An error was detected in data stored in the controller of this product.	Reset the set value.	
CH1-23	CH2-23	Communication Error WRN	Continued	An interruption of serial communication occurred between this product and your system.	Check that a signal is being issued from your system.	
					Check for disconnection of the communication connector from this product.	
CH1-24	CH2-24	DI Low Level WRN	Continued	Electrical resistivity of the circulating fluid falls short of your specified value. (optional)	Lower the setting for resistivity.	
					Replacement of the DI filter is required.	
CH1-25	CH2-25	Pump Inverter Error FLT	Stop	An error was detected in the pump inverter.	Contact the product supplier for request of inspection and repair.	

Table 6-1 Troubleshooting (3/3)

Code		Error message	Product condition	Cause	Remedies
CH1-28	CH2-28	CPRSR INV Error FLT-F0	Stop	An error was detected in the inverter for compressor.	Contact the product supplier for request of inspection and repair.
COM-99		Display Error FLT	Stop	An error was detected in the operation touch panel.	Contact the product supplier for request of inspection and repair.
---		Setting Data Clear	---	The internal clock, customer settings on the operation touch panel have been initialized. The battery depletion of the operation touch panel can be considered.	Replace the battery of the operation touch panel. After replacing the battery, set the internal clock and customer settings again. (If the power is turned off without changing the battery, the set values will be lost again)

Chapter 7 Product Maintenance

7.1 Water Quality Management

⚠ WARNING



Use specified circulating fluids only. If other fluids are used, they may damage the product or result in dangerous hazards. When using water, SMC recommends the water quality shown in following table as reference. In most areas, water can be used. However, if the water in the area is hard, there is a possibility of failure or performance decline due to limescale build-up. To soften the water and avoid problems, consider using water hardness filters.

Table 7-1 Water Quality Standards

	Substance	Facility water spec.	Circulating water spec.
Standards	pH (25°C)	6.5 to 8.2	6.0 to 8.0
	Electrical conductivity (25°C) (µs/cm)	100 to 800	0.5 to 300
	Chloride ion (mgCl-/L)	Max. 200	Max.50
	Sulfate ion (mgSO ₄ ²⁻ /L)	Max. 200	Max.50
	Acid consumption (pH4.8) (mgCaCO ₃ /L)	Max. 100	Max.50
	Total hardness (mgCaCO ₃ /L)	Max. 200	Max.70
	Calcium hardness (mgCaCO ₃ /L)	Max. 150	Max.50
	Ionic silica (mgSiO ₂ /L)	Max. 50	Max.30
	Iron (mgFe/L)	Max. 1.0	Max.0.3
	Copper (mgCu/L)	Max. 0.3	Max.0.1
	Sulfide ion (mgS ²⁻ /L)	Not be detected	
	Ammonium ion (mgNH ₄ ⁺ /L)	Max. 1.0	Max.0.1
	Residual chlorine (mgCl/L)	Max. 0.3	Max.0.3
	Free carbon dioxide (mgCO ₂ /L)	Max. 4.0	Max.4.0
Filtering (µm)	Max. 5		

* According to the Water quality guideline for refrigeration air-conditioning equipment: JRA-GL-02-1994

⚠ CAUTION



If the periodic inspection finds a nonconforming substance in the facility water, clean the facility water circuit and recheck the quality of the facility water.

⚠ CAUTION



Ensure the circulating fluid is not contaminated by oil, moisture, or foreign substances. Potential product failure due to insufficient cooling and freeze may occur if disregarded.

7.2 Inspection and Cleaning

⚠ WARNING



- Do not touch any electrical parts with wet hands. Keep wet hands away from electrical parts. Potential electric shock can occur if disregarded.
- Ensure the product is not sprayed with water. Potential electric shock or fire can occur if disregarded.

⚠ WARNING



If the inspection and cleaning require the removal of the panel, be sure to re-attach the panel upon completion. Potential personal injury or electric shock may occur if operated with the panel opened or removed.

7.2.1 Daily inspection

Table 7-2 Daily Inspection

Inspection item	Inspection method	
Installation condition	Check of the condition of product installation	No heavy object is placed on this product. This product should not be subjected to external force.
		Temperature and humidity are within the specified range.
Fluid leak	Check of the piping connector section	No leak of facility water and circulating fluid from the piping connector section
Fluid level	Reading of the level of the circulating fluid	Level is within the circulating fluid specified level between "High" and "Low".
Operation display panel	Display check	Clarity of letters and numbers on the LCD display should be assured.
	Function check	[RUN] lamp is ON.
Circulating fluid temperature	Confirm the reading on the LCD screen	Temperature should be within setpoint.
Discharge pressure of circulating fluid	Confirm the reading on the LCD screen	Reading should not have deviated much from last inspection.
Circulating fluid flow rate	Confirm the reading on the LCD screen	Reading should not have deviated much from last inspection.
Operating condition	Operating condition check	No abnormal noise, vibration, odor and smoke
Facility water	Check of the facility water	Temperature, flow rate and pressure fall within the specified range.
Circulating fluid supply port cap	Check by providing manual tightening	No looseness

7.2.2 Quarterly inspection



⚠ WARNING	
	<p>Quarterly inspection requires an advance lockout/tagout of the product. See section 1.5.3 “Lockout/Tagout” in Chapter 1 Safety Instructions” for details.</p>

Table 7-3 Quarterly Inspection

Inspection item	Inspection method
Circulating fluid	Circulating fluid is to be drained for check. Fluid should be free of particles, moisture*1 and foreign substances.
	For ethylene glycol solution, confirm that the concentration falls within the specified range.
	Recommended to replace the water.
Facility water	Facility water quality should be within the standards specified.
Ventilation hole and electrical parts	No particles and dust should be present.

CAUTION	
	<p>Moisture trapped in the fluorinated fluid (*1) freezes in the heat exchanger element and piping, which may lead to system failure.</p>

■ Cleaning of the product

If the product is dirty, clean it with a dry wipe or air blow.

7.3 Storage

The following should be performed for long-term storage of the product.

- 1.** Drain the circulating fluid. See section 7.3.1 “Draining of circulating fluid out of tank” for details.
- 2.** Drain the facility water. See section 7.3.2 “Draining of facility water” for details.
- 3.** Cover the product with a plastic sheet for storage.

7.3.1 Draining of circulating fluid out of tank

The refrigerating tank is designed to drain the circulating fluid from the drain port at the back of the product.

The water-cooled tank is designed to drain the circulating fluid from the drain port located at the back or front of the product.

CAUTION



- Use a clean container for circulating fluid recovery. Reuse of the recovered circulating fluid with contamination can cause insufficient cooling and system failure.
- Be sure to wait until the circulating fluid reaches room temperature before draining. Potential burns and dew intrusion may occur if disregarded.

■ Draining of circulating fluid from back

1. Prepare the container for circulating fluid recovery at the back of the product.

2. Connect the drain hoses to the main and sub tank drain ports each. Insert the tip of the hose into the container.

- Prepare a drain hose (Rc3/8-diameter) is your responsibility.

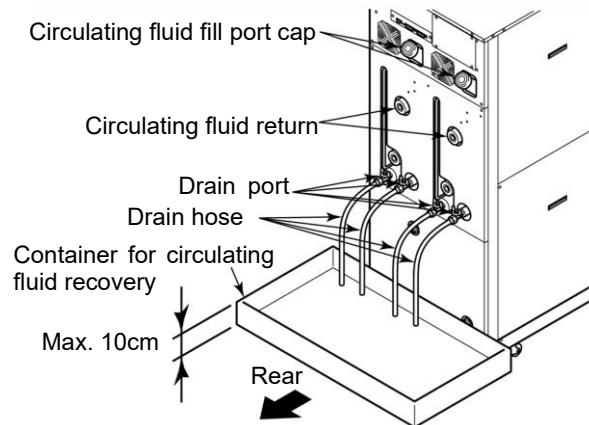

Figure 7-1 Container for Circulating Fluid Recovery

3. Remove the cap of the circulating fluid fill port.

4. Open the valves of the main and sub tank drain ports to drain the circulating fluid.

5. Apply air purge from the the circulating fluid return to push the circulating fluid remaining in the heat exchange back in the tank and drain it.

CAUTION



If the recovered circulating fluid is contaminated by foreign substances, completely remove them. Do not reuse contaminated fluid.
Potential insufficient cooling, product failure and froth in the circulating fluid may occur if disregarded.

CAUTION



Recovered circulating fluid must be sealed in a container to prevent contamination from moisture or foreign substances.
Stored in a cool, dark place.
Keep it from flame.

6. Upon completion of fluid draining, close the valves of the main and sub tank drain ports.

7. Add plugs to seal off ports on the rear of the product.

- Add plugs to seal off ports on the rear of the product.

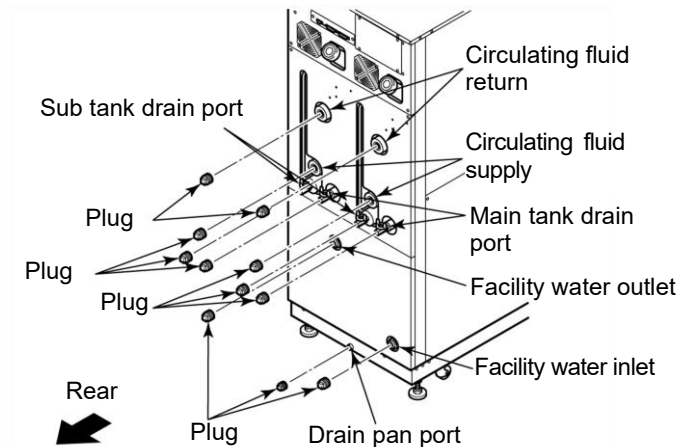



Figure 7-2 Plug Attachment

7.3.2 Draining of facility water

⚠ CAUTION



- **Be sure to drain the facility water only when it is at room temperature. Trapped fluid inside the product can still be hot. Potential burns can occur if disregarded.**

- 1.** Place the drain pan underneath the piping connections on the rear of the product.
 - At least a 7L capacity drain pan is required.

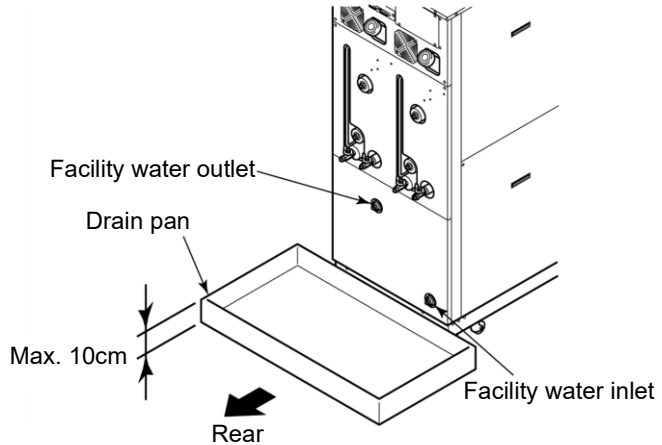

Figure 7-3 Drain Pan Attachment

- 2.** Remove facility water piping.
 - Remove the joints such as unions if present.

- 3.** Drain the facility water using the facility water inlet port.

7.4 Periodic Replacement Parts

Replacement of consumables listed in the following table is recommended. Contact the product supplier for request of part replacement.

Table 7-4 Periodic Replacement Part List

Part	Recommended replacement cycle
Internal pump	Every 3 yrs
Circulating pump	Every 3 yrs
Ventilating fan	Every 3 yrs
Compressor inverter cooling fan	Every 3 yrs
Circulating pump inverter fan	Every 3 yrs

* Note: A replacement cycle may vary with your usage condition.

Chapter 8 Appendix

8.1 Specification

8.1.1 Product specification

■ Specification for fluorinated fluid (wide temperature) double inverter (HRZD020-WS-WS)

Table 8-1 Specification for fluorinated fluid (wide temperature) double inverter (HRZD020-WS-WS)

Model		HRZD020-WS-WS	
		1	2
Channel		Water cooled refrigerant type	
Cooling method		Water cooled refrigerant type	
Temperature control system		PID control	PID control
Cooling capacity ^{*1}	kW	9.5 (Circulating fluid at 20°C)	9.5 (Circulating fluid at 20°C)
Operating temperature range	°C	-30 to 90	-30 to 90
Temperature stability	°C	±0.1 ^{*2}	±0.1 ^{*2}
Circulating fluid flow display range ^{*3}	L/min	5 to 40	5 to 40
Circulating fluid flow setting range ^{*4}	L/min	10 to 40	10 to 40
Circulating fluid discharge pressure display range	MPa	0 to 1.5	0 to 1.5
Circulating fluid		-30 to 40°C: Galden® HT135 ^{*5} Fluorinert™ FC-3283 ^{*5} 20 to 90°C: Galden® HT200 ^{*5} Fluorinert™ FC-40 ^{*5} (No intrusion of foreign body)	
Refrigerant		R404A (HFC)	R404A (HFC)
Quantity of refrigerant	kg	2.9	
Pump capacity ^{*6}	MPa	0.72 (At 20L/min) Inverter-driven flow control function applied	0.72 (At 20L/min) Inverter-driven flow control function applied
Main Tank capacity ^{*7}	L	Approx.15	Approx.15
Sub Tank capacity ^{*8}	L	Approx.16	Approx.16
Circulating fluid port (supply/return)		Rc 3/4	Rc 3/4
Facility water	°C / MPa	10 to 35 / 0.3 to 0.7	
Required flow of facility water ^{*9}	L/min	15 (Facility water at 25°C)	15 (Facility water at 25°C)
Facility water port (inlet/outlet)		Rc 1/2 (single system for channels 1,2)	
Power supply		3-phase 50/60Hz AC200/200 to 208V±10%	
Rated flow ^{*10}	L/min	20	20
Max. operating current	A	52	
Main breaker size	A	60	
Temperature fuse operating temperature	°C	98	98
Dimensions ^{*11}	mm	W600×D845×H1525	
Weight ^{*12}	kg	380	
Communication		Serial RS-232C/485 (Dsub-9pin), Contact signal / Analog (Dsub-25pin)	
Materials of circulating fluid wetted parts		SUS, EPDM, copper brazing (heat exchanger), PPS, silicone, fluoroplastics	
Maximum height difference between the unit and the external equipment ^{*13}	m	Max. 10	Max. 10

- *1: The capacity is derived under the conditions that the facility water temp. is 25°C and that the circulating fluid flows at 20L/min, if the heat source is direct-coupled to the circulating fluid circuit of the product. Available cooling capacity decreases with increase in the length of piping to the customer system, causing an endothermic reaction.
- *2: The discharge temperature (this system) is derived under the conditions that the rated flow of the circulating fluid is obtained and that the circulating fluid supply is direct-coupled to the circulating fluid return. The installation environment, power supply, and facility water must be in the working range and stable.
- *3: The valve must be fully opened to use when connected to the circulating fluid supply.
- *4: Circulating fluid flow control may be disabled with respect to the set values, depending on piping specifications on your system.
- *5: Galden® is a registered trademark of Solvay Solexis, and Fluorinert™ is a trademark of U.S. 3M.
- *6: The capacity is derived at the Outlet of this system when the circulating fluid temp. is at 20°C.
- *7: This is a minimum amount of the fluid for operation of the Thermo Chiller outfitted with internal piping and heat exchanger in this system. Circulating fluid temp.: 20°C
- *8: This is an auxiliary space with a main tank capacity excluded. The level of the fluid in external piping must be under a sub tank capacity.

- *9: This value will be needed to when temperature will be going down. If the product is under no or light load, it is operational at approx. 1 to 2L/min of facility water.
- *10: The rated flow is a required flow rate to maintain cooling capacity and temperature stability. Always use the accessory “by-pass piping set” if the fluid falls below the rated flow.
- *11: This is the dimensions of panels, which is derived without protrusions such as a breaker handle.
- *12: This is the mass of the system when it contains no circulating fluid.
- *13: If the difference of elevation measures more than 10m, the level of the circulating fluid in 7-m or longer piping must be under a sub tank capacity. The circulating fluid may boil or back-flow which causes overflow from the tank when the product is at a halt, if disregarded.

■ Specification for ethylene glycol solution (wide temperature) double inverter (HRZD020-W1S-W1S)

Table 8-2 Specification for ethylene glycol solution (wide temperature) double inverter (HRZD020-W1S-W1S)

Model		HRZD020-W1S-W1S	
		1	2
Channel		1	2
Cooling method		Water cooled refrigerant type	
Temperature control system		PID control	
Cooling capacity ^{*1}	kW	9.5 (Circulating fluid at 20°C)	9.5 (Circulating fluid at 20°C)
Operating temperature range	°C	-20 to 90	-20 to 90
Temperature stability	°C	±0.1 ^{*2}	±0.1 ^{*2}
Circulating fluid flow display range ^{*3}	L/min	5 to 40	5 to 40
Circulating fluid flow setting range ^{*4}	L/min	10 to 40	10 to 40
Circulating fluid discharge pressure display range	MPa	0 to 1.5	0 to 1.5
Circulating fluid		Ethylene glycol solution 60% ^{*5} (No intrusion of foreign body)	
Refrigerant		R404A (HFC)	R404A (HFC)
Quantity of refrigerant	kg	2.9	
Pump capacity ^{*6}	MPa	0.40 (At 20L/min) Inverter-driven flow control function applied	0.40 (At 20L/min) Inverter-driven flow control function applied
Main Tank capacity ^{*7}	L	Approx.15	Approx.15
Sub Tank capacity ^{*8}	L	Approx.16	Approx.16
Circulating fluid port (supply/return)		Rc 3/4	Rc 3/4
Facility water	°C / MPa	10 to 35 / 0.3 to 0.7	
Required flow of facility water ^{*9}	L/min	15 (Facility water at 25°C)	15 (Facility water at 25°C)
Facility water port (inlet/outlet)		Rc 1/2 (single system for channels 1,2)	
Power supply		3-phase 50/60Hz AC200/200 to 208V±10%	
Rated flow ^{*10}	L/min	20	20
Max. operating current	A	52	
Main breaker size	A	60	
Temperature fuse operating temperature	°C	98	98
Dimensions ^{*11}	mm	W600×D845×H1525	
Weight ^{*12}	kg	380	
Communication		Serial RS-232C/485 (Dsub-9pin), Contact signal / Analog (Dsub-25pin)	
Materials of circulating fluid wetted parts		SUS, EPDM, copper brazing (heat exchanger), PPS, silicone, fluoroplastics	
Maximum height difference between the unit and the external equipment ^{*13}	m	Max. 10	Max. 10

- *1: The capacity is derived under the conditions that the facility water temp. is 25°C and that the circulating fluid flows at 20L/min, if the heat source is direct-coupled to the circulating fluid circuit of the product. Available cooling capacity decreases with increase in the length of piping to the customer system, causing an endothermic reaction.
- *2: The discharge temperature (this system) is derived under the conditions that the rated flow of the circulating fluid is obtained and that the circulating fluid supply is direct-coupled to the circulating fluid return. The installation environment, power supply, and facility water must be in the working range and stable.
- *3: The valve must be fully opened to use when connected to the circulating fluid supply.
- *4: Circulating fluid flow control may be disabled with respect to the set values, depending on piping specifications on your system.
- *5: Pure ethylene glycol needs dilution with fresh water before use. Ethylene glycol with additives such as preservatives is NOT available.
- *6: The capacity is derived at the Outlet of this system when the circulating fluid temp. is at 20°C.
- *7: This is a minimum amount of the fluid for operation of the Thermo Chiller outfitted with internal piping and heat exchanger in this system. Circulating fluid temp.: 20°C
- *8: This is an auxiliary space with a main tank capacity excluded. The level of the fluid in external piping must be under a sub tank capacity.
- *9: This value will be needed to when temperature will be going down. If the product is under no or light load, it is operational at approx. 1 to 2L/min of facility water.
- *10: The rated flow is a required flow rate to maintain cooling capacity and temperature stability. Always use the accessory "by-pass piping set" if the fluid falls below the rated flow.
- *11: This is the dimensions of panels, which is derived without protrusions such as a breaker handle.
- *12: This is the mass of the system when it contains no circulating fluid.
- *13: If the difference of elevation measures more than 10m, the level of the circulating fluid in 7-m or longer piping must be under a sub tank capacity. The circulating fluid may boil or back-flow which causes overflow from the tank when the product is at a halt, if disregarded.

■ Specification for ethylene glycol solution/ fluorinated fluid (wide temperature) double inverter (HRZD020-W1S-WS)

Table 8-3 Specification for ethylene glycol solution/ fluorinated fluid (wide temperature) double inverter (HRZD020-W1S-WS)

Model		HRZD020-W1S-WS	
Channel		1	2
Cooling method		Water cooled refrigerant type	
Temperature control system		PID control	PID control
Cooling capacity ^{*1}	kW	9.5 (Circulating fluid at 20°C)	9.5 (Circulating fluid at 20°C)
Operating temperature range	°C	-20 to 90	-30 to 90
Temperature stability	°C	±0.1 ^{*2}	±0.1 ^{*2}
Circulating fluid flow display range ^{*3}	L/min	5 to 40	5 to 40
Circulating fluid flow setting range ^{*4}	L/min	10 to 40	10 to 40
Circulating fluid discharge pressure display range	MPa	0 to 1.5	0 to 1.5
Circulating fluid		Ethylene glycol solution 60% ^{*5}	-30 to 40°C: Galden® HT135 ^{*5} Fluorinert™ FC-3283 ^{*5} 20 to 90°C: Galden® HT200 ^{*5} Fluorinert™ FC-40 ^{*5}
		(No intrusion of foreign body)	
Refrigerant		R404A (HFC)	R404A (HFC)
Quantity of refrigerant	kg	2.9	
Pump capacity ^{*6}	MPa	0.40 (At 20L/min) Inverter-driven flow control function applied	0.72 (At 20L/min) Inverter-driven flow control function applied
Main Tank capacity ^{*7}	L	Approx.15	Approx.15
Sub Tank capacity ^{*8}	L	Approx.16	Approx.16
Circulating fluid port (supply/return)		Rc 3/4	Rc 3/4
Facility water	°C / MPa	10 to 35 / 0.3 to 0.7	
Required flow of facility water ^{*9}	L/min	15 (Facility water at 25°C)	15 (Facility water at 25°C)
Facility water port (inlet/outlet)		Rc 1/2 (single system for channels 1,2)	
Power supply		3-phase 50/60Hz AC200/200 to 208V±10%	
Rated flow ^{*10}	L/min	20	20
Max. operating current	A	52	
Main breaker size	A	60	
Temperature fuse operating temperature	°C	98	98
Dimensions ^{*11}	mm	W600×D845×H1525	
Weight ^{*12}	kg	380	
Communication		Serial RS-232C/485 (Dsub-9pin), Contact signal / Analog (Dsub-25pin)	
Materials of circulating fluid wetted parts		SUS, EPDM, copper brazing (heat exchanger), PPS, silicone, fluoroplastics	
Maximum height difference between the unit and the external equipment ^{*13}	m	Max. 10	Max. 10

*1: The capacity is derived under the conditions that the facility water temp. is 25°C and that the circulating fluid flows at 20L/min, if the heat source is direct-coupled to the circulating fluid circuit of the product. Available cooling capacity decreases with increase in the length of piping to the customer system, causing an endothermic reaction.

*2: The discharge temperature (this system) is derived under the conditions that the rated flow of the circulating fluid is obtained and that the circulating fluid supply is direct-coupled to the circulating fluid return. The installation environment, power supply, and facility water must be in the working range and stable.

*3: The valve must be fully opened to use when connected to the circulating fluid supply.

*4: Circulating fluid flow control may be disabled with respect to the set values, depending on piping specifications on your system.

*5: Pure ethylene glycol needs dilution with fresh water before use. Ethylene glycol with additives such as preservatives is NOT available. Galden® is a registered trademark of Solvay Solexis, and Fluorinert™ is a trademark of U.S. 3M.

*6: The capacity is derived at the Outlet of this system when the circulating fluid temp. is at 20°C.

*7: This is a minimum amount of the fluid for operation of the Thermo Chiller outfitted with internal piping and heat exchanger in this system. Circulating fluid temp.: 20°C

*8: This is an auxiliary space with a main tank capacity excluded. The level of the fluid in external piping must be under a sub tank capacity.

*9: This value will be needed to when temperature will be going down. If the product is under no or light load, it is operational at approx. 1 to 2L/min of facility water.

*10: The rated flow is a required flow rate to maintain cooling capacity and temperature stability. Always use the accessory "by-pass

pipng set" if the fluid falls below the rated flow.

*11: This is the dimensions of panels, which is derived without protrusions such as a breaker handle.

*12: This is the mass of the system when it contains no circulating fluid.

*13: If the difference of elevation measures more than 10m, the level of the circulating fluid in 7-m or longer piping must be under a sub tank capacity. The circulating fluid may boil or back-flow which causes overflow from the tank when the product is at a halt, if disregarded.

■ Specification for fluorinated fluid / ethylene glycol solution (wide temperature) double inverter (HRZD020-WS-W1S)

Table 8-4 Specification for fluorinated fluid / ethylene glycol solution (wide temperature) double inverter (HRZD020-WS-W1S)

Model		HRZD020-WS-W1S	
Channel		1	2
Cooling method		Water cooled refrigerant type	
Temperature control system		PID control	
Cooling capacity ^{*1}	kW	9.5 (Circulating fluid at 20°C)	9.5 (Circulating fluid at 20°C)
Operating temperature range	°C	-30 to 90	-20 to 90
Temperature stability	°C	±0.1 ^{*2}	±0.1 ^{*2}
Circulating fluid flow display range ^{*3}	L/min	5 to 40	5 to 40
Circulating fluid flow setting range ^{*4}	L/min	10 to 40	10 to 40
Circulating fluid discharge pressure display range	MPa	0 to 1.5	0 to 1.5
Circulating fluid		-30 to 40°C: Galden® HT135 ^{*5} Fluorinert™ FC-3283 ^{*5} 20 to 90°C: Galden® HT200 ^{*5} Fluorinert™ FC-40 ^{*5}	Ethylene glycol solution 60% ^{*5}
(No intrusion of foreign body)			
Refrigerant		R404A (HFC)	R404A (HFC)
Quantity of refrigerant	kg	2.9	
Pump capacity ^{*6}	MPa	0.72 (At 20L/min) Inverter-driven flow control function applied	0.40 (At 20L/min) Inverter-driven flow control function applied
Main Tank capacity ^{*7}	L	Approx.15	Approx.15
Sub Tank capacity ^{*8}	L	Approx.16	Approx.16
Circulating fluid port (supply/return)		Rc 3/4	Rc 3/4
Facility water	°C / MPa	10 to 35 / 0.3 to 0.7	
Required flow of facility water ^{*9}	L/min	15 (Facility water at 25°C)	15 (Facility water at 25°C)
Facility water port (inlet/outlet)		Rc 1/2 (single system for channels 1,2)	
Power supply		3-phase 50/60Hz AC200/200 to 208V±10%	
Rated flow ^{*10}	L/min	20	20
Max. operating current	A	52	
Main breaker size	A	60	
Temperature fuse operating temperature	°C	98	98
Dimensions ^{*11}	mm	W600×D845×H1525	
Weight ^{*12}	kg	380	
Communication		Serial RS-232C/485 (Dsub-9pin), Contact signal / Analog (Dsub-25pin)	
Materials of circulating fluid wetted parts		SUS, EPDM, copper brazing (heat exchanger), PPS, silicone, fluoroplastics	
Maximum height difference between the unit and the external equipment ^{*13}	m	Max. 10	Max. 10

*1: The capacity is derived under the conditions that the facility water temp. is 25°C and that the circulating fluid flows at 20L/min, if the heat source is direct-coupled to the circulating fluid circuit of the product. Available cooling capacity decreases with increase in the length of piping to the customer system, causing an endothermic reaction.

*2: The discharge temperature (this system) is derived under the conditions that the rated flow of the circulating fluid is obtained and that the circulating fluid supply is direct-coupled to the circulating fluid return. The installation environment, power supply, and facility water must be in the working range and stable.

*3: The valve must be fully opened to use when connected to the circulating fluid supply.

*4: Circulating fluid flow control may be disabled with respect to the set values, depending on piping specifications on your system.

*5: Galden® is a registered trademark of Solvay Solexis, and Fluorinert™ is a trademark of U.S. 3M. Pure ethylene glycol needs dilution with fresh water before use. Ethylene glycol with additives such as preservatives is NOT available.

*6: The capacity is derived at the Outlet of this system when the circulating fluid temp. is at 20°C.

*7: This is a minimum amount of the fluid for operation of the Thermo Chiller outfitted with internal piping and heat exchanger in this system. Circulating fluid temp.: 20°C

*8: This is an auxiliary space with a main tank capacity excluded. The level of the fluid in external piping must be under a sub tank capacity.

*9: This value will be needed to when temperature will be going down. If the product is under no or light load, it is operational at approx. 1 to 2L/min of facility water.

*10: The rated flow is a required flow rate to maintain cooling capacity and temperature stability. Always use the accessory "by-pass piping set" if the fluid falls below the rated flow.

- *11: This is the dimensions of panels, which is derived without protrusions such as a breaker handle.
- *12: This is the mass of the system when it contains no circulating fluid.
- *13: If the difference of elevation measures more than 10m, the level of the circulating fluid in 7-m or longer piping must be under a sub tank capacity. The circulating fluid may boil or back-flow which causes overflow from the tank when the product is at a halt, if disregarded.

8.1.2 Refrigerant with GWP reference

Table8-5 Refrigerant with GWP reference

Refrigerant	Global Warming Potential (GWP)		
	Regulation (EU) No 517/2014 (Based on the IPCC AR4)	Fluorocarbon Emission Control Law	
		Revised Fluorocarbons Recovery and Destruction Law (Japanese law)	Calculated leakage amount, etc. Reporting Notification Factor
R134a	1,430	1,430	1,300
R404A	3,922	3,920	3,940
R407C	1,774	1,770	1,620
R410A	2,088	2,090	1,920
R448A	1,387	1,390	1,270
R454C	148	145	146

Note:

1. This product is hermetically sealed and contains fluorinated greenhouse gases.
2. See specification table for refrigerant used in the product.

8.1.3 Communication specification

This section provides the general outline of communications utilized in this product.

For detail specification, we provide a separate product manual "Communication Specification", which is available through your local distributor.

■ Contact signal / Analog communication

Table 8-6 Contact signal / Analog communication

Item	Specification	
Connector No.	P1(CH1), P2(CH2)	
Connector type (this product)	D-sub25P female connector (M2.6×0.45)	
Input signal	Insulation type	Photocoupler
	Rated input voltage	DC24V
	Used voltage range	DC 21.6V to 26.4V
	Rated input current	5mA TYP
	Input impedance	4.7kΩ
Contact output signal (Other than Pin No. 5-18)	Rated load voltage	Max. AC48V / Max. DC30V
	Max. load current	Max. AC/DC 800mA (Pin No.15 is common to output signals. Total used load current should be at or below 800mA.)
Contact output signal (Pin No. 5-18)	Rated load voltage	Max. AC48V / Max. DC30V
	Max. load current	AC/DC 800mA (resistance load)
Contact output signal (EMO signal)	Rated load voltage	Max. AC48V / Max. DC30V
	Max. load current	AC/DC 800mA (resistance load, inductive load)
Analog input signal	Input voltage range	-10V to +10V
	Input impedance	1MΩ
	Input accuracy	Max. ±0.2%F.S.
Analog output signal	Output voltage range	-10V to +10V
	Max. output current	10mA
	Output accuracy	Max. ±0.4%F.S.

Circuit block diagram (P1, P2)

Pin	Item
1	DC+24V output
14	24COM
3	Start/stop signal 1
16	Start/stop signal 2
4	DIO REMOTE signal 1 Recovery signal ^{*1}
17	DIO REMOTE signal 2
6	OUT1
19	OUT2
7	OUT3
20	OUT4
8	OUT5
15	Contact output COM
5	OUT6
18	
11	ANALOG OUTPUT 1
23	
10	ANALOG OUTPUT 2
22	
12	ANALOG INPUT
24	
13	EMO signal
25	

^{*1}: The recovery signal can be input only when the circulating fluid automatic collection function (optional) is used, and it does not serve as the DIO REMOTE signal.

■ **Serial RS-485, RS-232C**

Table 8-7 Serial RS-485, RS-232C

Item	Specification
Connector No.	P3
Connector type (this product)	D-sub9P female connector (M2.6×0.45)
Standard	EIA RS-485, RS-232C
Protocol	Modicon Modbus
Circuit block diagram	<p>When RS-485 is selected</p> <p>When RS-232C is selected</p>

[Tips]

Serial RS-485 and RS-232C must be used separately. See section “5.3.18 Communication setting screen” on page 5-27 for selection of communication specifications.

⚠ CAUTION



- In case of using serial communication, mount the ferrite core (accessory) to serial communication cable (1turn). It causes a communication trouble by the noise if it does not mount it.

8.1.4 Alarm signal selection

User can designate alarm signal separately for contact signal (OUT1 to OUT6). See section 5.3.22 “CH1(2)DIO communication setting screen 2” in “Chapter 5 Product Operation” on page 5-33 for signal selecting.

The following table presents the setting-alarm relationship.

Table 8-8 Alarm signal selection

Setting	Alarm	Alarm No.
N/A	Alarm signal remains ON (closed) under normal circumstances.	—
Alarm1	Water Leak Detect FLT	01
Alarm2 ^{*1}	-	02
Alarm3	RFGT High Press FLT	03
Alarm4 ^{*1}	-	04
Alarm5	Reservoir Low Level FLT	05
Alarm6	Reservoir Low Level WRN	06
Alarm7	Reservoir High Level WRN	07
Alarm8	Temp. Fuse Cutout FLT	08
Alarm9	Reservoir High Temp. FLT	09
Alarm10 ^{*1}	-	10
Alarm11	Reservoir High Temp. WRN	11
Alarm12	Discharge Low Flow FLT	12
Alarm13	Discharge Low Flow WRN	13
Alarm14	Heater Breaker Trip FLT	14
Alarm15	Pump Breaker Trip FLT	15
Alarm16	CPRSR Breaker Trip FLT	16
Alarm17	Interlock Fuse Cutout FLT	17
Alarm18 ^{*2}	DC Fuse Cutout WRN	18
Alarm19	FAN Motor Stop WRN	19
Alarm20	Internal Pump Time Out WRN	20
Alarm21	Controller Error FLT	21
Alarm22	Memory Data Error FLT	22
Alarm23	Communication Error WRN	23
Alarm24 ^{*2}	DI Low Level WRN	24
Alarm25	Pump Inverter Error FLT	25
Alarm26 ^{*1}	-	26
Alarm27 ^{*1}	-	27
Alarm28	CPRSR Inverter Error FLT	28
Alarm29	-	29
Alarm30	-	30
Alarm31	-	31
Alarm32	-	32

● Example

With parameter “OUT” on the Initial Setting screen set to “Alarm1”, alarm “Water Leak Detect FLT” is detected, the alarm contact signal is switched to OFF (open).

*1: Alarms 2, 10, 26, 27, and 29 to 32 are assigned with no alarm. The alarm signal remains ON (closed) despite Alarm10 being specified.

*2: Alarms 18 and 24 are alarms indicating accessories (optional).

8.2 Outer Dimensions

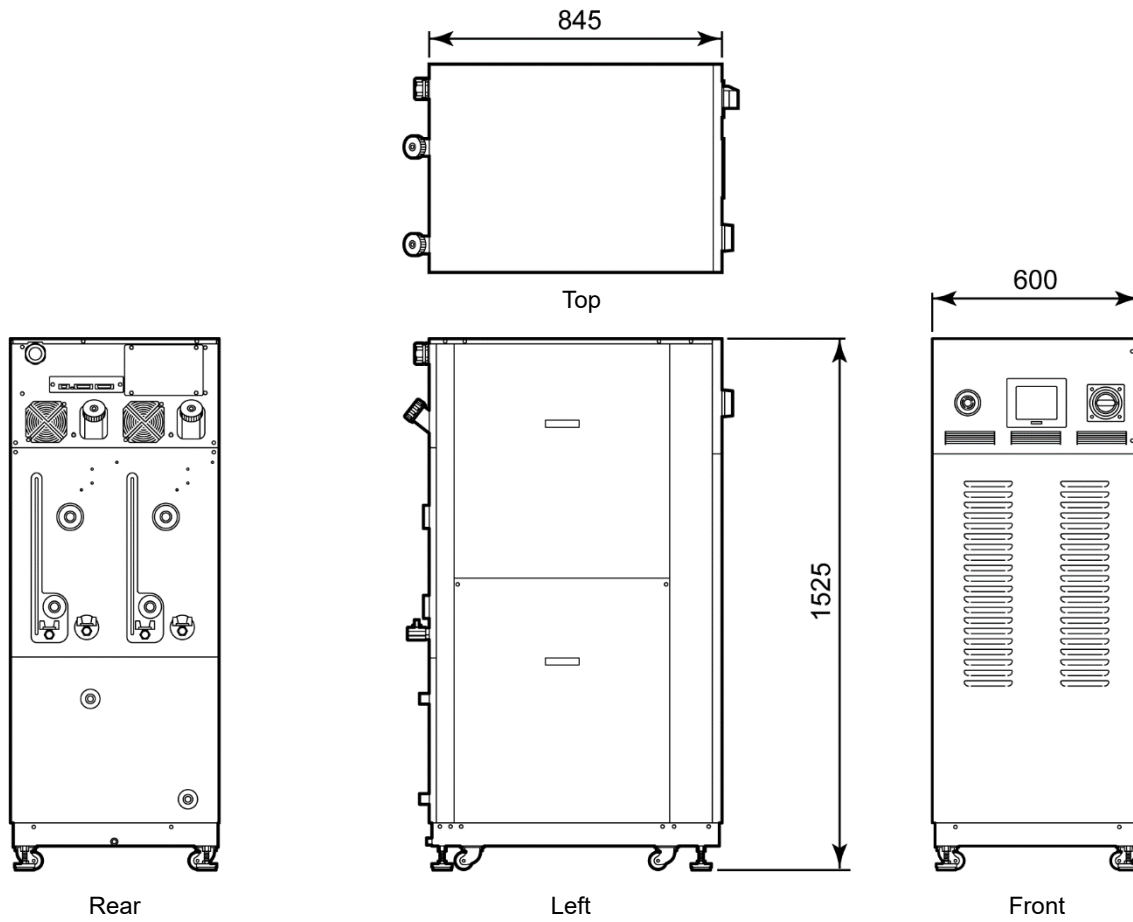

Figure 8-1 Outer Dimensions (Dimensional Tolerance: $\pm 10\text{mm}$)

8.3 Flow Chart

8.3.1 HRZD020-WS-WS, HRZD020-W1S-W1S, HRZD020-W1S-WS, HRZD020-WS-W1S

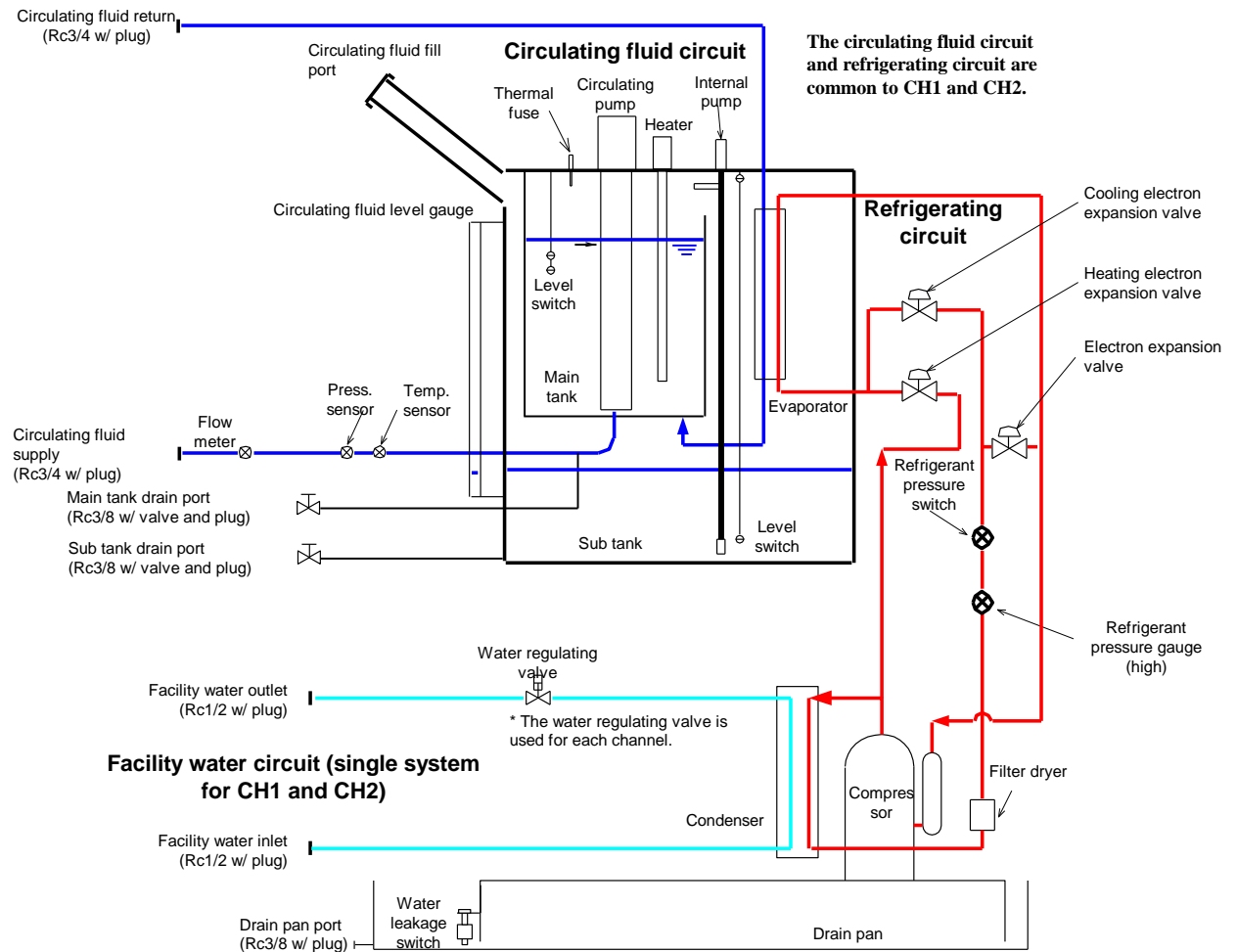

Figure 8-2 Refrigeration Flow Chart

8.4 Offset Function

Potential deviations in temperature between this product and your system may occur depending on the installation environment. The offset function has three types (MODE1 to 3) to calibrate any deviations in temperature.

See the following descriptions for the offset function. See section 5.3.29 “CH1(2) offset setting screen” in “Chapter 5 Product Operation” on page 5-47 for setting.

The fluid temperature value sent communications is the same value as TEMP PV, which is displayed on the Status screen.

● When MODE1 is selected

This mode is used to exercise temperature control to allow the discharge temperature of the circulating fluid to be “TEMP SP value + OFFSET value”. TEMP PV value denotes the discharge temperature of the circulating fluid.

E.g.: TEMP SP value: +20°C, OFFSET value: +2°C
→ Circulating fluid discharge temp.: +22°C, TEMP PV: +22°C

● When MODE2 is selected

This mode is used to exercise temperature control to allow the discharge temperature of the circulating fluid to be “TEMP SP value”. TEMP PV value denotes “Circulating fluid discharge temp. value + OFFSET value”.

E.g.: TEMP SP value: +20°C, OFFSET value: +2°C
→ Circulating fluid discharge temp.: +20°C, TEMP PV: +22°C

● When MODE3 is selected

This mode is used to exercise temperature control to allow the discharge temperature of the circulating fluid to be “TEMP SP value + OFFSET value”. TEMP PV value denotes “Circulating fluid discharge temp. value - OFFSET value”.

E.g.: TEMP SP value: +20°C, OFFSET value: +2°C
→ Circulating fluid discharge temp.: +22°C, TEMP PV: +20°C

● When OFF is selected

If no mode is selected, temperature control is conducted to allow the discharge temperature of the circulating fluid to be “TEMP SP value”.

[Tips]

The “Main screen” on page 5-5 allows the checking of the selected offset mode.

8.4.1 Example of offset function

When the discharge temperature of the circulating fluid is at 30°C, heat is dissipated by 1°C so the circulating fluid in your system to be 29°C. Under the above condition, the following process is to be performed with the utilization of MODEs 1 to 3.

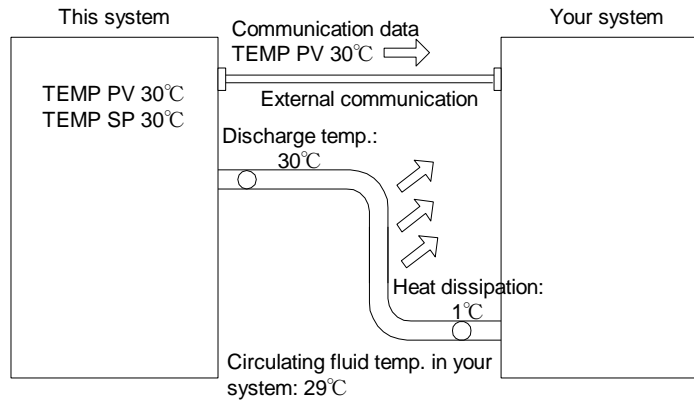

Figure 8-3 Example of Offset Function

■ When MODE1 is selected

This mode enables this product to exercise temperature control to obtain 31°C (TEMP SP value +OFFSET value), with OFFSET value set at 1°C. Once the discharge temperature of the circulating fluid becomes 31°C, 1°C-thermal dissipation occurs to allow the circulating fluid in your system to be 30°C. TEMP SP value is obtained for your system.

Note that “31°C” is recorded in TEMP PV and communication data.

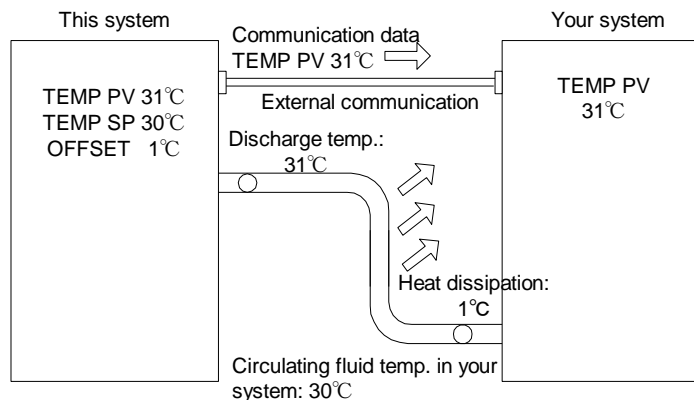

Figure 8-4 When MODE1 is selected

■ When MODE2 is selected

With OFFSET value set at -1°C , TEMP PV and communication data shows “ 29°C ” (circulating fluid discharge temp. value + OFFSET value) that agrees with the temperature of the circulating fluid in your system.

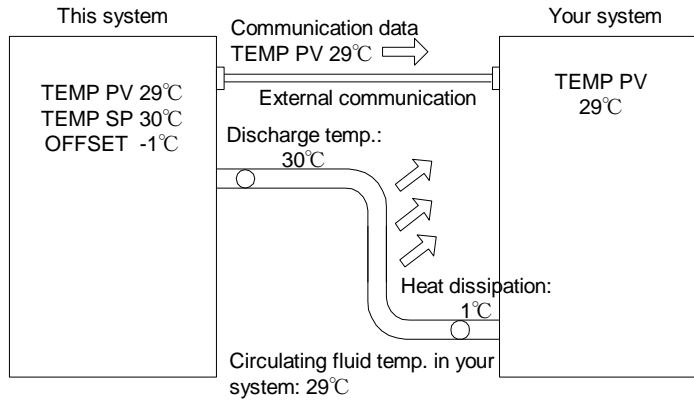

Figure 8-5 When MODE2 is selected

■ When MODE3 is selected

This mode enables this product to exercise temperature control to obtain 31°C (TEMP SP value + OFFSET value), with OFFSET value set at 1°C . Once the discharge temperature of the circulating fluid becomes 31°C , 1°C -thermal dissipation is occurs to allow the circulating fluid in your system to be 30°C . TEMP SP value is obtained for your system. TEMP PV and communication data also express “ 30°C ” (circulating fluid discharge temp. value - OFFSET value) that agrees with the temperature of the circulating fluid in your system.

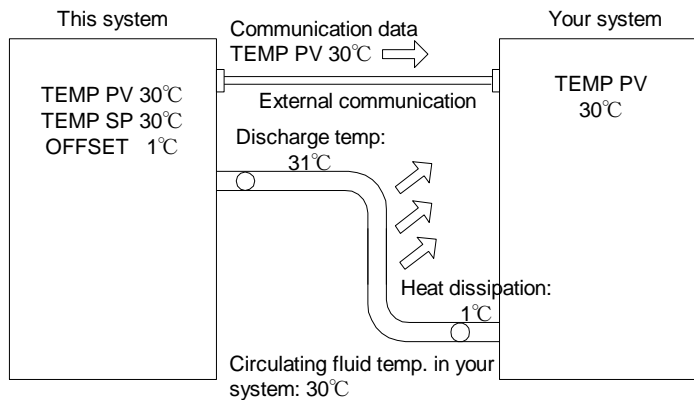

Figure 8-6 When MODE3 is selected

8.5 BAND/READY Function

Sets BAND to TEMP SP value, and notifies TEMP PV value reaches within BAND range by the operation display panel or the communication.

See section 5.3.4 “CH1(2) setting data screen 1, 2” in “Chapter 5 Product Operation” on page 5-7 for the procedure of the setting.

● When the setting is ON

Allows the setting of the BAND and READY TIME. Allows the setting of the communication output.

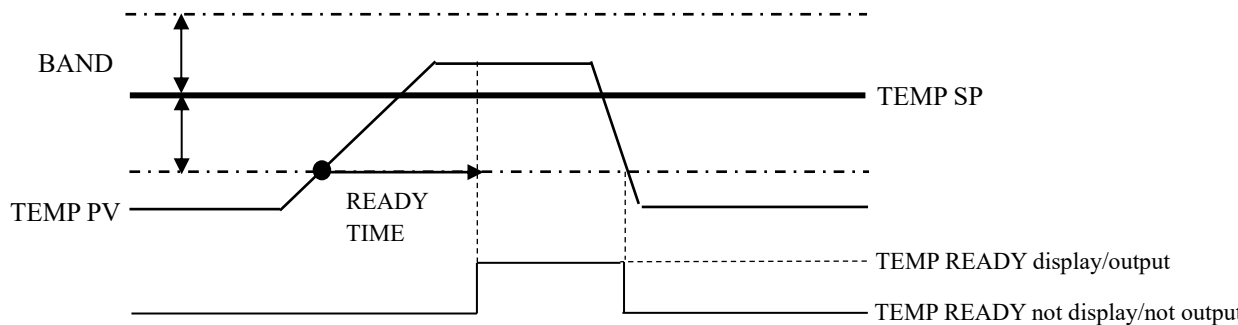

Figure 8-7 BAND/READY Function

● Examples of Setting

TEMP SP: 20°C

BAND: 2°C

READY TIME: 60 sec.

- “RDY” is displayed on the operation touch panel 60 sec. after TEMP PV value becomes 18°C to start output by communication. Necessary condition is that TEMP PV value after 60-sec. is 20±2.0°C or less. See section “5.3.2 Main screen” on page 5-5 for the details of display position.

8.6 Anchor Bolt Mounting Position

Adjust and secure the adjuster foot of the product to the anti-seismic bracket.

⚠ CAUTION



- Anti-seismic bracket is an accessory, which is recommended for the installation of the product.
- It is your responsibility to prepare anchor bolts suitable for your floor material.
- M12-anchor bolts (8 pcs.) are required.

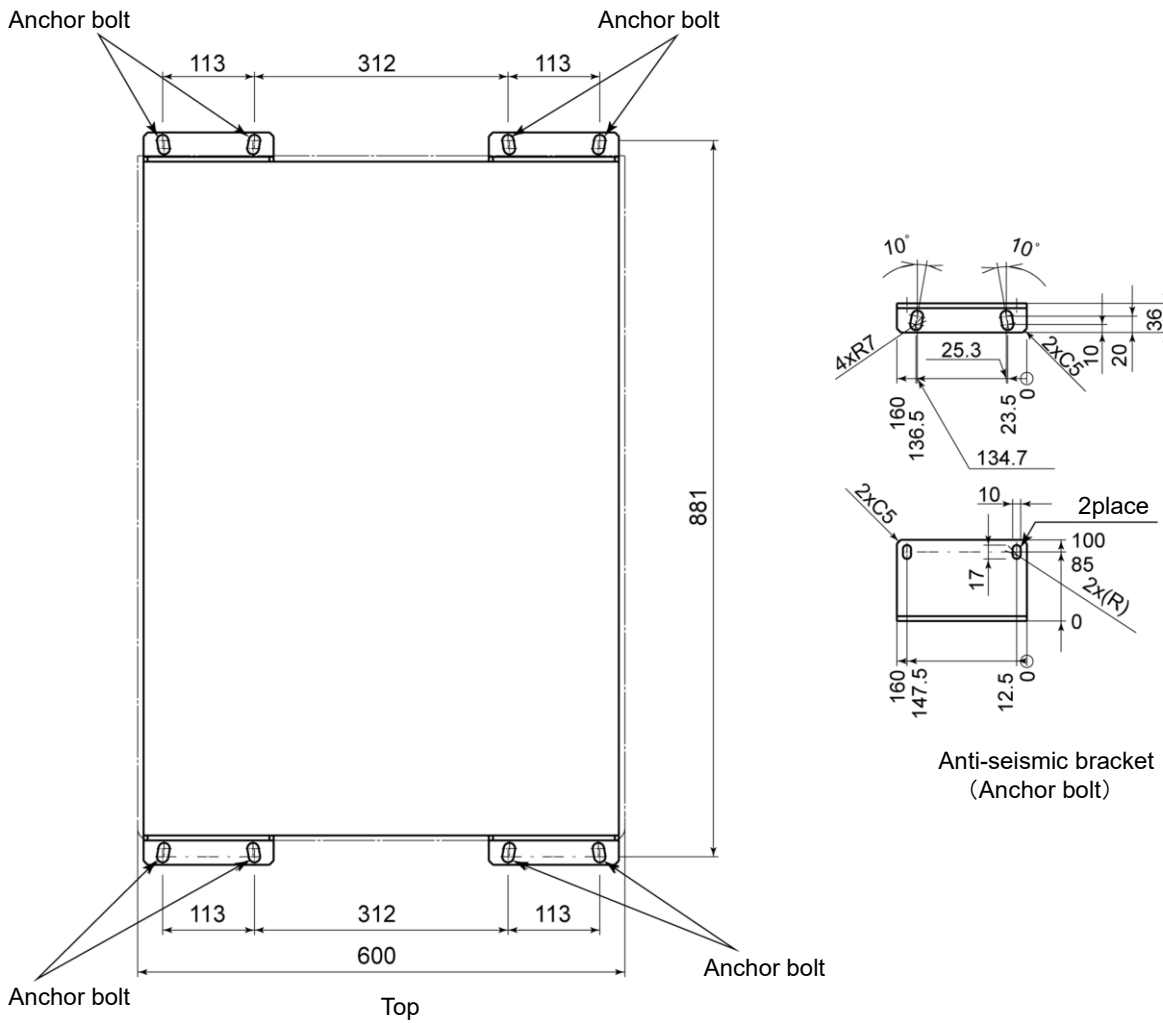

Figure 8-8 Anchor Bolt Mounting Position

8.7 Compliance

This product conforms to the following standards.

Table 8-9 Compliance

CE Marking	EMC Directive	2004/108/EC
	Low Voltage Directive	2006/95/EC
	Machinery Directive	2006/42/EC
	Overvoltage Category	Category 2 (IEC60664-1)
	Pollution Degree	Degree 2 (IEC60664-1)
SEMI	S2-0706、S8-0308、F47-0706	

Chapter 9 Limited warranty and Disclaimer/ Compliance Requirements

The product used is subject to the following “Limited warranty and Disclaimer” and “Compliance Requirements”. Read and accept them before using the product.

1. Conditions of warranty

When a nonconformance should take place to our temperature control equipment, we will repair the unit without charge in accordance with our current terms and conditions.

This free repair covers the replacement of all nonconforming parts, their adjustment and checks. Please note that the disassembled parts will be the property of SMC.

2. Period of warranty

The warranty period of the product is 1 year in service or 1.5 years after the product is delivered, whichever is first.

3. Items out of warranty

The following cases are not subject to warranty.

1. Nonconformance caused by implementing no check-up (daily check-up, regular check-up) specified by SMC.
2. Nonconformance caused by the usage other than stipulated in the operating manual or outside the specification designated by SMC.
3. Nonconformance caused by remodeling which is not permitted by SMC.
4. Nonconformance caused by the usage other than the specified circulating fluid or facility water.
5. Nonconformance caused by elapsing. (painted surface, plated surface discolored naturally)
6. Sensuous phenomenon which is not affected functionally (sound, noise, vibration, etc.)
7. Nonconformance caused by natural disasters such as earthquake, typhoon, water disaster, accidents, or fire hazard.
8. Nonconformance caused by the installation environment stipulated in the operating manual.
9. Nonconformance caused by no observation to the following 5, “Items to be observed by customer.”

4. Exemption from liability

1. Cost for daily check-up, regular check-up.
2. Cost for repair by a third party other than the designated distributors or agents.
3. Cost for moving this unit and installation or dislocation.
4. Cost for replacement or replenishment of the component parts or liquid other than specified.
5. Cost for inconvenience or loss caused by not being able to use the unit. (Telephone charge, warranty for job suspension, commercial loss, etc.)
6. Cost or compensation, etc. stipulated other than the above 1. “Conditions of warranty.”

5. Items to be observed by customer

In order to use this product safely, the correct usage and check-up by customer are necessary. Please be sure to observe the following things. Please note that we may decline the repair request upon warranty in case that the following things are not observed.

- 1) Use the unit in accordance to the proper handling as mentioned in the Operation Manual.
- 2) Conduct inspection and maintenance (daily check-up, regular check-up) as mentioned in the Operating Manual.
- 3) Record the inspection and maintenance results as mentioned in the Operating Manual.

6. How to ask a repair upon warranty

When a warranty repair is requested, please contact the nearest sales distributor. With this, we will repair the unit upon warranty.

We promise a repair for free on the basis of the above mentioned periods or terms. Therefore, nonconformance occurred after the warranty period will be charged in princip

『Compliance Requirements』

The use of SMC products with production equipment for the manufacture of weapons of mass destruction (WMD) or any other weapon is strictly prohibited. The exports of SMC products or technology from one country to another are governed by the relevant security laws and regulations of the countries involved in the transaction. Prior to the shipment of a SMC product to another country, assure that all local rules governing that export are known and followed.

Revision history
Rev.H : Aug. 2024

SMC Corporation

Tel: + 81 3 5207 8249 Fax: +81 3 5298 5362

URL <https://www.smcworld.com>

Note: Specifications are subject to change without prior notice and any obligation on the part of the manufacturer.
© SMC Corporation All Rights Reserved